



CIRCUIT BREAKER 3VA2 IEC FRAME 100 BREAKING CAPACITY CLASS H ICU=85KA @ 415 V 3POLE, LINE PROTECTION ETU850, LSI, IN=25A OVERLOAD PROTECTION IR=10A ...25A SHORT CIRCUIT PROTECTION ISD=0,6..10X IN, II=1,5..12X IN NEUTRAL PROTECTION OPTIONAL WITH EXT. CT,UPTO 160% BUSBAR CONNECTION

Model		
product brand name		SENTRON
Product designation		Molded case circuit breaker
Design of the product		Line protection
Product variations		Selective Applications
Ground fault monitoring version		Without
Design of the auxiliary release		without auxiliary release
Design of the auxiliary switch		Without
Design of the operating mechanism		toggle handle
Type of the driving mechanism / motor drive		No
Design of the overcurrent release		ETU850
General technical data		
Number of poles		3
Trip class / of the L-trip / with I ² t characteristic / initial value		0.5
Trip class / of the L-trip / with I ² t characteristic / Full-scale value		25
Electrical endurance (switching cycles)		12 000
• at AC-1 / at 380/415 V / at 50/60 Hz		
circuit-breaker / Design		3VA
Mechanical service life (switching cycles) / typical		20 000
Voltage		
Insulation voltage / Rated value	V	800
Protection class		

Protection class IP		IP40
Protection class IP / on the front		IP40
Protective function of the overcurrent release		LSI

Switching capacity

Switching capacity class of the circuit breaker		H
--	--	---

Dissipation

Active power loss		
<ul style="list-style-type: none"> • maximum 	W	0.84

Electricity

Continuous current / Rated value / maximum	A	100
Continuous current / Rated value	A	25
Adjustable response value current / of the instantaneous short-circuit release / initial value	A	1.5

Main circuit

Operating voltage		
<ul style="list-style-type: none"> • with AC / at 50/60 Hz / Rated value 	V	690
Operating current		
<ul style="list-style-type: none"> • at 40 °C / Rated value • at 50 °C / Rated value • at 60 °C / Rated value • at 65 °C / Rated value • at 70 °C / Rated value 	A	25
	A	25
	A	25
	A	25
	A	25

Auxiliary circuit

Number of NC contacts / for auxiliary contacts		0
Number of NO contacts / for auxiliary contacts		0

Suitability

Suitability for use		system protection
----------------------------	--	-------------------

Adjustable parameters

Adjustable response value current		
<ul style="list-style-type: none"> • of I-trip / Full-scale value • of the short-time delayed short-circuit release / initial value • of the short-time delayed short-circuit release / Full-scale value • of S-trip / with standard characteristic / initial value • of S-trip / with standard characteristic / Full-scale value 	A	12
	A	0.6
	A	10
	A	0.6
	A	10
Adjustable delay time		
<ul style="list-style-type: none"> • of S-trip / with I2t characteristic / initial value 	s	0.05

• of S-trip / with I2t characteristic / Full-scale value	s	0.5
• of S-trip / with standard characteristic / initial value	s	0.05
• of S-trip / with standard characteristic / Full-scale value	s	0.5
Adjustable response value current / of the current-dependent overload release / initial value	A	0.4

Product details

Product component		
• Trip indicator		No
• display		Yes
• undervoltage release		No
Product property		
• for neutral conductors / upgradeable/retrofitable / Short-circuit and overload proof		Yes
Product expansion / optional / motor drive		Yes

Product function

Product function		
• Intrinsic device protection		Yes
• communication function		Yes
• Phase failure detection		No
• other measurement function		Yes

Accessories

Manufacturer article number / of the supplied basic switch		3VA2025-6KP32-0AA0
---	--	------------------------------------

Short circuit

Operational short-circuit current breaking capacity (Ics)		
• at 240 V / Rated value	kA	110
• at 415 V / Rated value	kA	85
• at 440 V / Rated value	kA	85
• at 500 V / Rated value	kA	55
• at 690 V / Rated value	kA	2
Maximum short-circuit current breaking capacity (Icu)		
• at 240 V / Rated value	kA	110
• at 415 V / Rated value	kA	85
• at 440 V / Rated value	kA	85
• at 500 V / Rated value	kA	55
• at 690 V / Rated value	kA	2
Short-circuit current making capacity (Icm)		

- at 240 V / Rated value
- at 415 V / Rated value
- at 440 V / Rated value
- at 500 V / Rated value
- at 690 V / Rated value

kA	242
kA	187
kA	187
kA	121
kA	3

Connections

Arrangement of electrical connectors / for main current circuit		Front terminal
Type of connectable conductor cross-section		13 x 1 mm
<ul style="list-style-type: none"> • for flat-bar terminal connection / minimum • for flat-bar terminal connection / maximum 		25 x 8.5
Type of electrical connection / for main current circuit		Lug terminal

Mechanical Design

Height	mm	181
Width	mm	105
Depth	mm	107
Mounting type		fixed mounting

Environmental conditions

Ambient temperature		
<ul style="list-style-type: none"> • during operation / minimum • during operation / maximum • during storage / minimum • during storage / maximum 	°C	-25
	°C	70
	°C	-40
	°C	80

Certificates

Equipment marking		
<ul style="list-style-type: none"> • acc. to DIN EN 61346-2 • acc. to DIN EN 81346-2 		Q
		Q

General Product Approval	EMC	Declaration of Conformity	Shipping Approval
---------------------------------	------------	----------------------------------	--------------------------



[other](#)



Shipping Approval	other
--------------------------	--------------

[other](#)



GL

Further information

Information- and Downloadcenter (Catalogs, Brochures,...)

<http://www.siemens.com/lowvoltage/catalogs>

Industry Mall (Online ordering system)

<https://eb.automation.siemens.com/mall/en/WW/Catalog/Product/3VA20256KP320AA0>

Service&Support (Manuals, Certificates, Characteristics, FAQs,...)

<http://support.automation.siemens.com/WW/view/en/3VA20256KP320AA0/all>

Image database (product images, 2D dimension drawings, 3D models, device circuit diagrams, ...)

http://www.automation.siemens.com/bilddb/cax_en.aspx?mfb=3VA20256KP320AA0

CAX-Online-Generator

<http://www.siemens.com/cax>

Tender specifications

<http://ausschreibungstexte.siemens.com/tiplv>

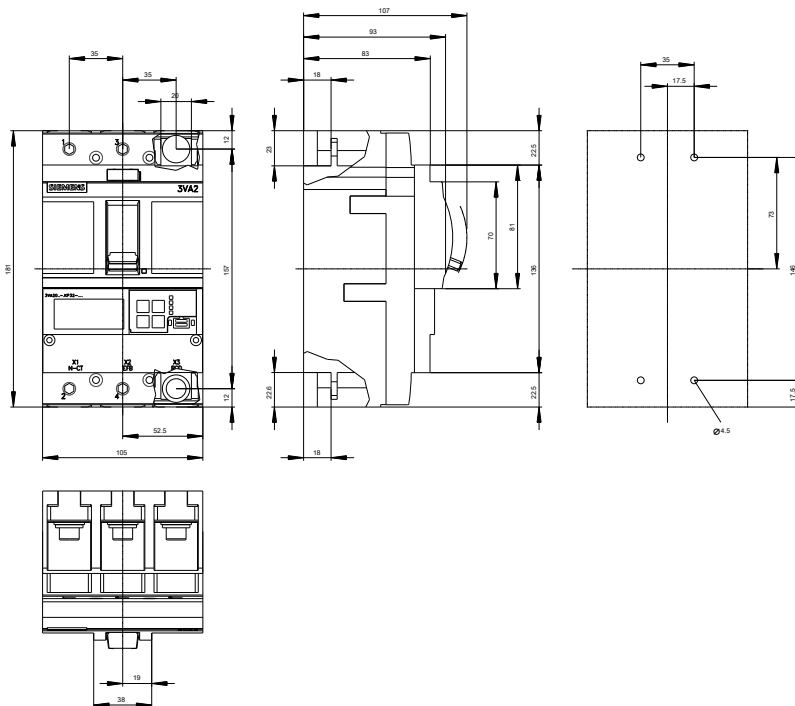

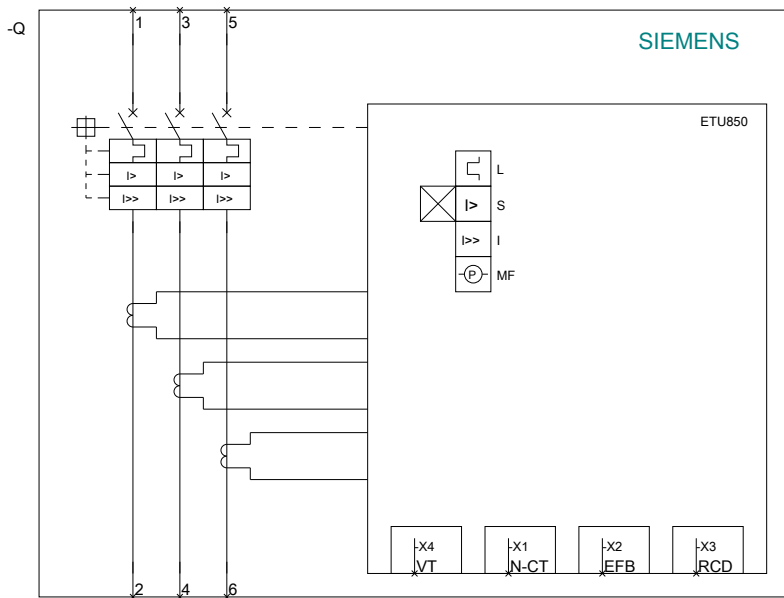

last modified:

11.03.2015