













B&W OUTDOOR.CASE TYP 2000

Artikelnummer: 2000/Y

	30 Jahre Garantie		leicht zu öffnende Schösser
	temperaturstabil		flugtauglich
	zwei Ösen für Vorhängeschlösser (Ø 4,5 mm)		stapelbar
	gummierter Tragegriff		extrem robust
	wasserdicht nach IP67		staubdicht

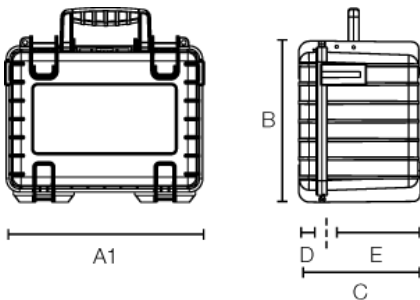

A (A1):	270 mm
B:	215 mm
C:	165 mm
A (A1) innen:	250 mm
B innen:	175 mm
C innen:	155 mm
D (Deckel) innen:	25 mm
E (Boden) innen:	130 mm

Produkteigenschaften

Innenausstattung	leer vorgestanzter Würfelschaum (SI) variable Facheinteilung (RPD)
Zertifikate	ATA 300 DEF STAN 81-41 STANAG 4280 IP67 MIL-STD-801G UN 3090/91 UN 3480/81
Material	PP
Volumen (L)	6,6

Zubehör

Deckeltasche (LP) für B&W outdoor.cases
Einbaurahmen (PF) für B&W outdoor.cases
Schultergurt (CS) für B&W outdoor.cases
Netztasche (MB) für B&W outdoor.cases



B&W International GmbH | Junkendiek 5 | D-49479 Ibbenbüren
Fon + 49 (0) 54 51 / 89 46-0 | Fax + 49 (0) 54 51 / 89 46-444 | info@b-w-international.com

www.b-w-international.com