



TAOGLAS®



Datasheet

Part No:
GA.111.101111

Description:
3dBi Mini Magnetic Mount 4G Cellular Antenna
698~960MHz, 1400~1518MHz, 1710~2700MHz

Features:
Covers worldwide 4G bands
Typical 30%+ Efficiency and 3dBi Peak Gain
Robust High Strength Magnet Mount
Cable: 1m RG-174
Connector: SMA(M)
Dimensions: 82.8*30*7.8mm
RoHS & Reach Compliant

1. Introduction	3
2. Specifications	4
3. Antenna Characteristics	6
4. Radiation Patterns	8
5. Mechanical Drawing	15
6. Magnetic Pull Force	16
7. Packaging	17
8. Application Note	18
<hr/>	
Changelog	22

Taoglas makes no warranties based on the accuracy or completeness of the contents of this document and reserves the right to make changes to specifications and product descriptions at any time without notice. Taoglas reserves all rights to this document and the information contained herein. Reproduction, use or disclosure to third parties without express permission is strictly prohibited.



1. Introduction



The GA.111 magnetic ultra-wideband cellular antenna delivers stable high omnidirectional gain and efficiencies across all common 4G, 3G and 2G global cellular bands from 698MHz to 2.7GHz.

Typical Applications Include:

- Payment Terminals
- Smart Metering
- Smart Home

This high performing antenna can be used for all cellular devices and will not require changing antennas when deploying from country to country or technology to technology like CDMA to GSM. Being magnetic mount, it is designed to be mounted on a ground plane for optimal performance. A reliable return loss of < -5dB when mounted on a metal plate ensures it complies with the industry standards set by module makers and networks worldwide. Taoglas recommends using the antenna with 1m cable length or less and can provide customized connectors and cable lengths upon customer requirements.

The strong magnet base is extremely stable and robust, using only high quality neodymium magnets for a secure magnetic mount to ensure a high pull force to disengage.

Cables and connectors are customizable. Contact your regional Taoglas customer support team for further information.

2. Specifications

5G/4G Electrical								
Band	Frequency (MHz)	Ground Plane	Efficiency (%)	Average Gain (dB)	Peak Gain (dBi)	Impedance	Return Loss	Polarization
4G/3G Band 12,13,14,17,28,29	698~806	Free space	28.9	-5.50	-0.74	50Ω	<-5dB	Linear
		30*30cm Ground Plane	61.1	-2.18	2.21			
4G/3G Band 12,13,14,17,28,29	824~894	Free space	47.1	-3.28	1.42			
		30*30cm Ground Plane	65.2	-1.88	2.41			
4G/3G Band 5,8,18,19,20,26,27	880~960	Free space	42.7	-3.69	0.55			
		30*30cm Ground Plane	58.6	-2.32	1.92			
5G/4G Band 21,32,74,75,76	1427~1518	Free space	42.56	-3.60	0.80			
		30*30cm Ground Plane	35.00	-4.26	0.16			
4G/3G Band 2,3,4,9,25,35,66	1710~1880	Free space	44.50	-3.53	1.16			
		30*30cm Ground Plane	36.90	-4.37	1.71			
4G/3G Band 1,2,3,9,25,35,39	1850~1990	Free space	52.81	-2.78	1.89			
		30*30cm Ground Plane	48.19	-3.18	3.09			
4G/3G Band 1,2,4,23,25,66	1920~2170	Free space	55.95	-2.53	1.89			
		30*30cm Ground Plane	54.02	-2.69	3.39			
4G/3G Band 7,30,38,40,41	2300~2690	Free space	33.52	-4.92	1.06			
		30*30cm Ground Plane	43.17	-3.79	3.16			
Mechanical								
Dimensions (mm)	82.8*30*7.8							
Cable	1 Meter RG-174 Coaxial Cable							
Casing	TPEE							
Connector	SMA(M)							
Magnetic Pull Force.	Vertical: <1.8Kgf Horizontal:<0.8Kgf							
Weight	43g							
Temperature Range	-40°C to 85°C							
Humidity	Non-condensing 65°C 95% RH							

5G/4G Bands			
Band Number	5G NR / FR1 / LTE / LTE-Advanced / WCDMA / HSPA / HSPA+ / TD-SCDMA		
	Uplink	Downlink	Covered
1	UL: 1920 to 1980	DL: 2110 to 2170	✓
2	UL: 1850 to 1910	DL: 1930 to 1990	✓
3	UL: 1710 to 1785	DL: 1805 to 1880	✓
4	UL: 1710 to 1755	DL: 2110 to 2155	✓
5	UL: 824 to 849	DL: 869 to 894	✓
7	UL: 2500 to 2570	DL: 2620 to 2690	✓
8	UL: 880 to 915	DL: 925 to 960	✓
9	UL: 1749.9 to 1784.9	DL: 1844.9 to 1879.9	✓
11	UL: 1427.9 to 1447.9	DL: 1475.9 to 1495.9	✓
12	UL: 699 to 716	DL: 729 to 746	✓
13	UL: 777 to 787	DL: 746 to 756	✓
14	UL: 788 to 798	DL: 758 to 768	✓
17	UL: 704 to 716	DL: 734 to 746	✓
18	UL: 815 to 830	DL: 860 to 875	✓
19	UL: 830 to 845	DL: 875 to 890	✓
20	UL: 832 to 862	DL: 791 to 821	✓
21	UL: 1447.9 to 1462.9	DL: 1495.9 to 1510.9	✓
22	UL: 3410 to 3490	DL: 3510 to 3590	✓
23	UL: 2000 to 2020	DL: 2180 to 2200	✓
24	UL: 1625.5 to 1660.5	DL: 1525 to 1559	✗
25	UL: 1850 to 1915	DL: 1930 to 1995	✓
26	UL: 814 to 849	DL: 859 to 894	✓
27	UL: 807 to 824	DL: 852 to 869	✓
28	UL: 703 to 748	DL: 758 to 803	✓
29	UL: -	DL: 717 to 728	✓
30	UL: 2305 to 2315	DL: 2350 to 2360	✓
31	UL: 452.5 to 457.5	DL: 462.5 to 467.5	✗
32	UL: -	DL: 1452 to 1496	✓
35		1850 to 1910	✓
38		2570 to 2620	✓
39		1880 to 1920	✓
40		2300 to 2400	✓
41		2496 to 2690	✓
42		3400 to 3600	✓
43		3600 to 3800	✗
48		3550 to 3700	✓
66	UL: 1710-1780	DL: 2110-2200	✓
71		617 to 698	✗
74/75/76		1427 to 1518	✓
77		3300 to 4200	✗
78		3300 to 3800	✓
79		4400 to 5000	✗

3. Antenna Characteristics

3.1 Return Loss

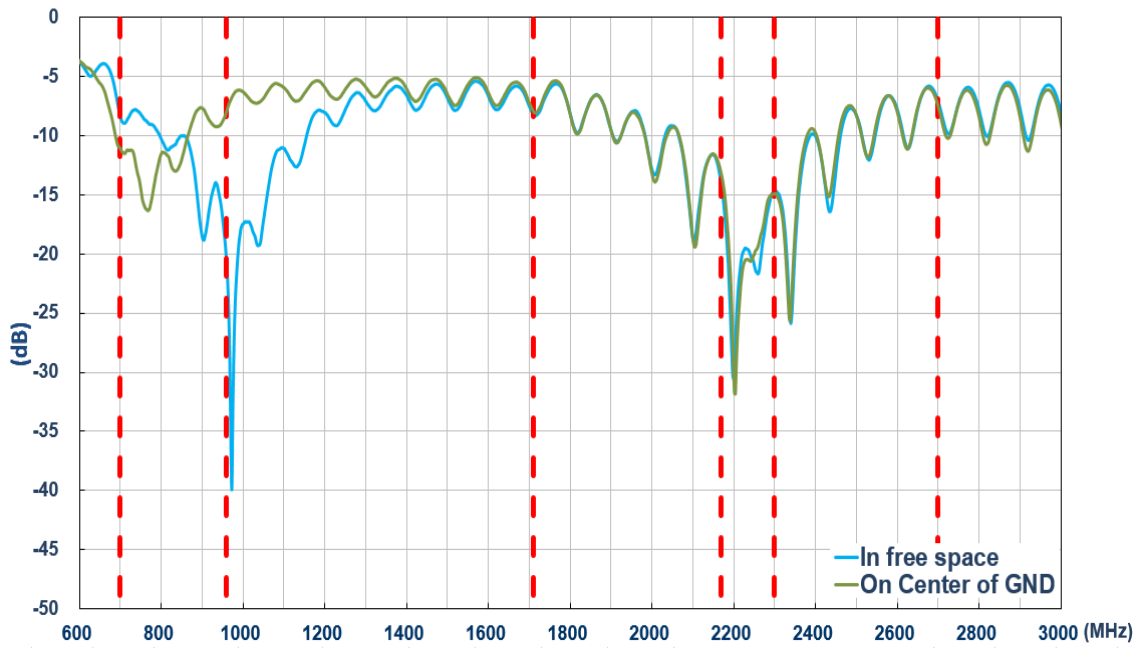

3.2 Efficiency

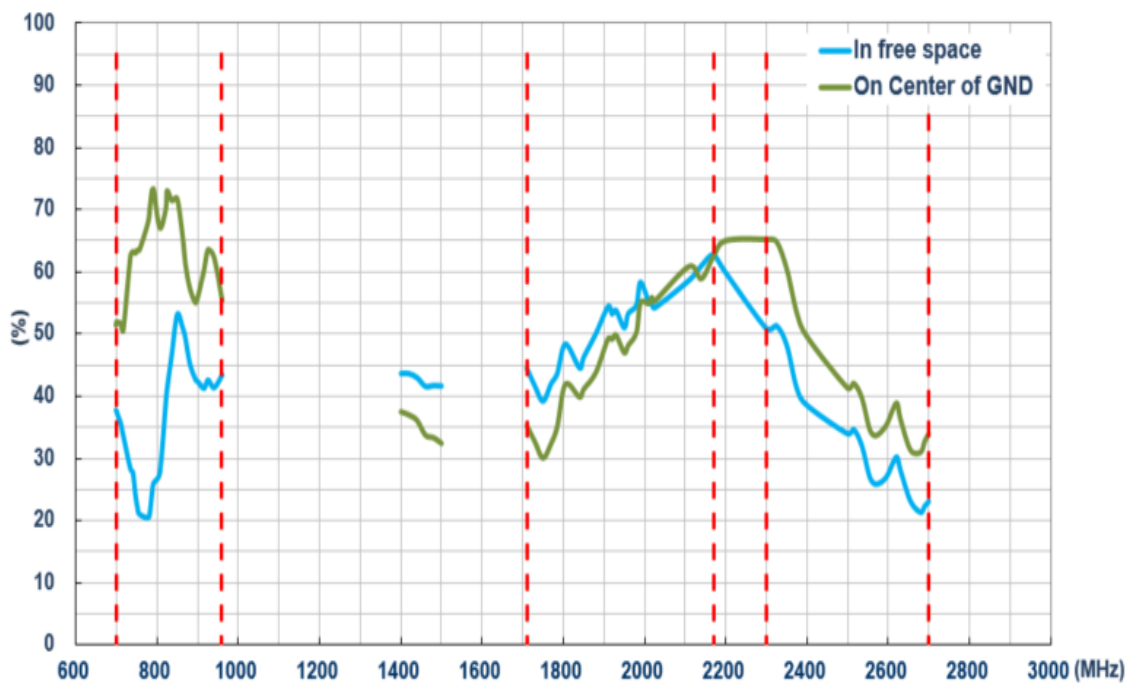

3.3 Peak Gain

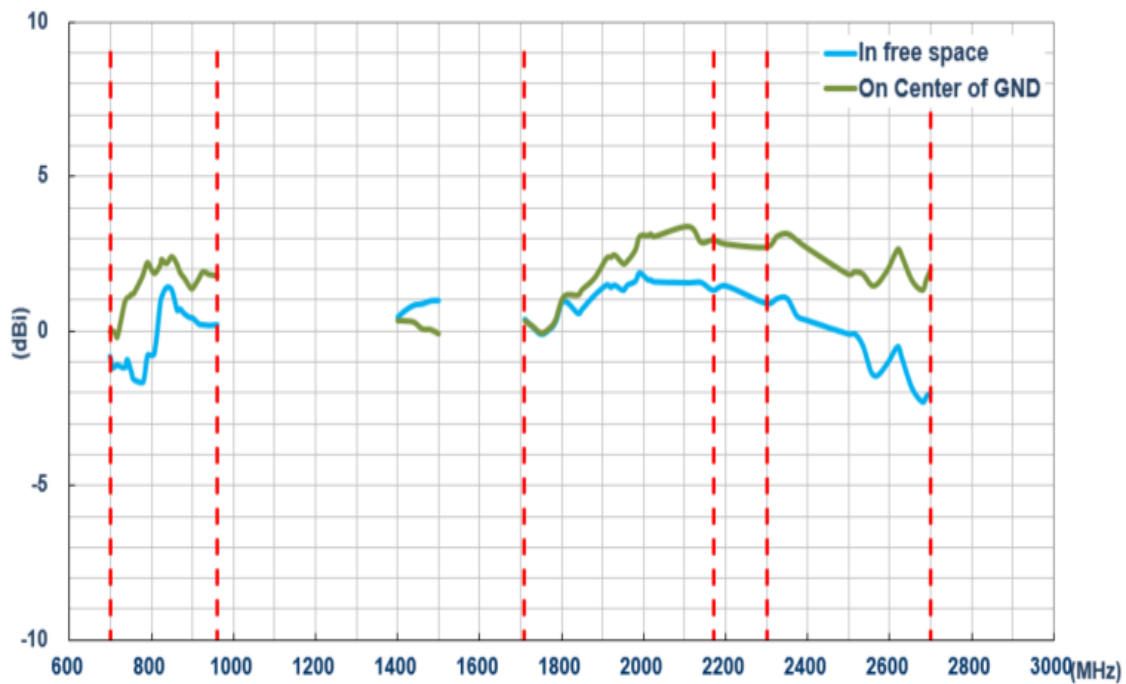

3.4 Average Gain

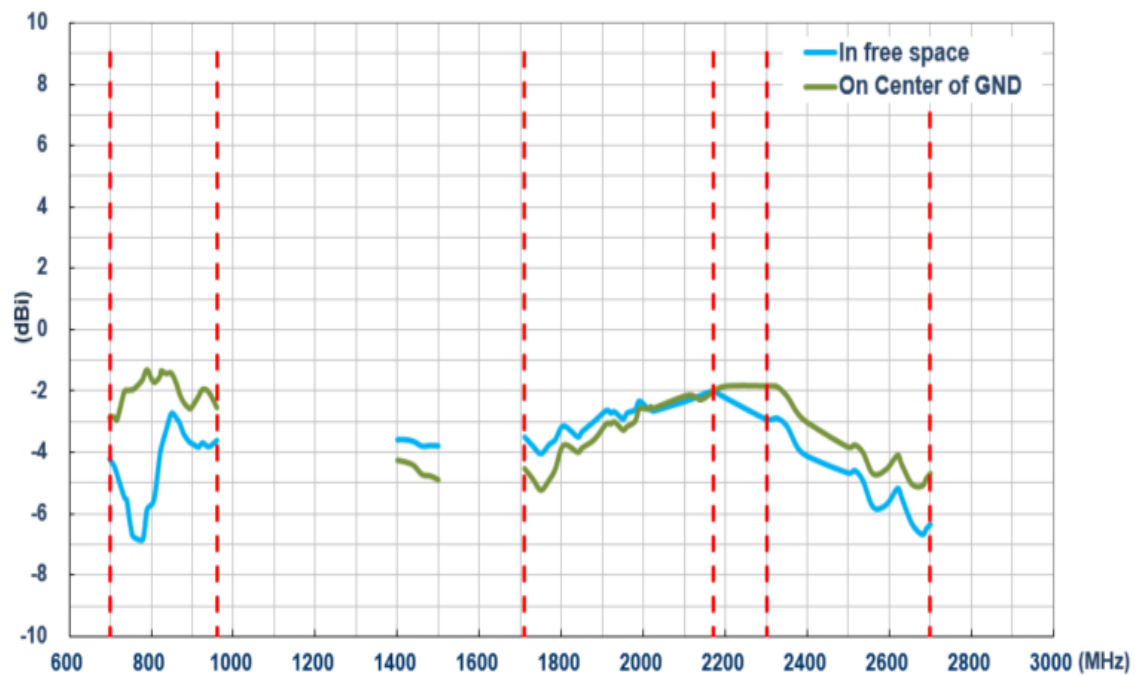

4. Radiation Patterns

4.1 Test Setup



In free space

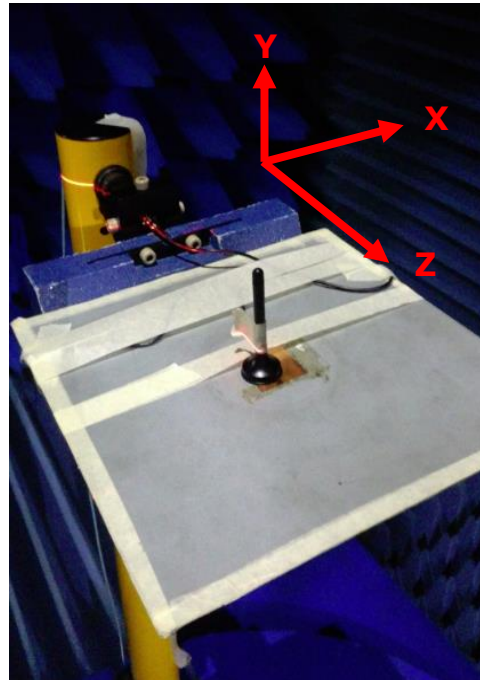

On 30*30cm Ground Center

4.2 3D and 2D Radiation Patterns – Free Space

704MHz

960MHz

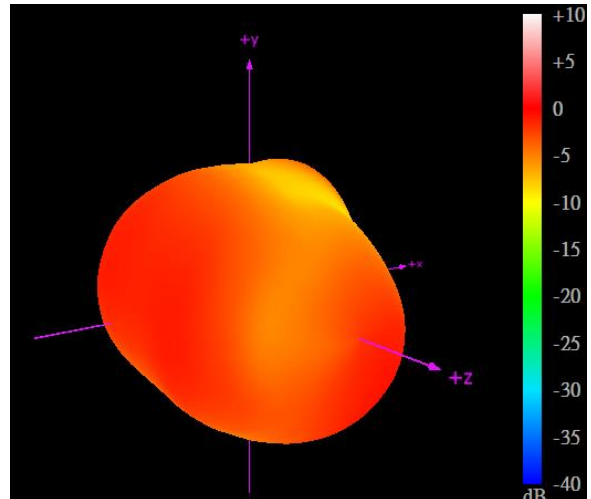
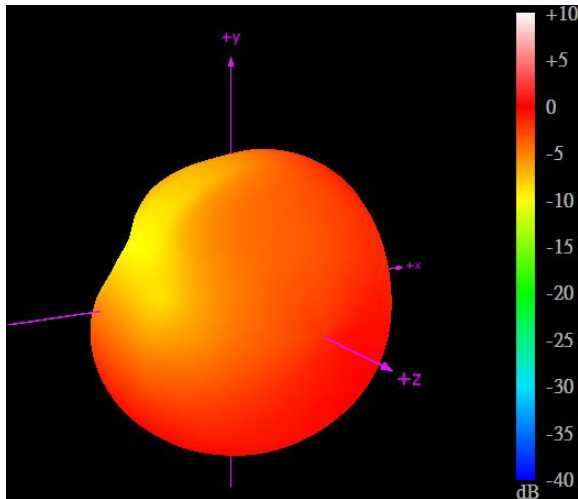

XY Plane

XZ Plane

YZ Plane

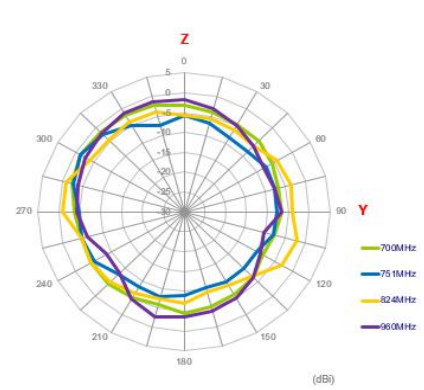
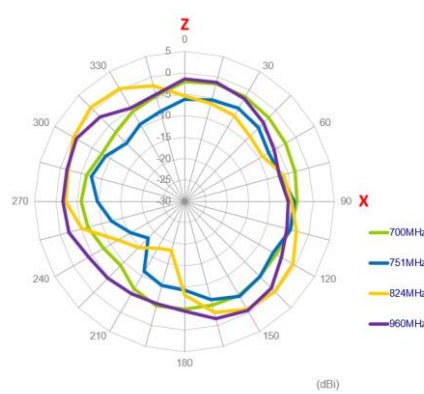
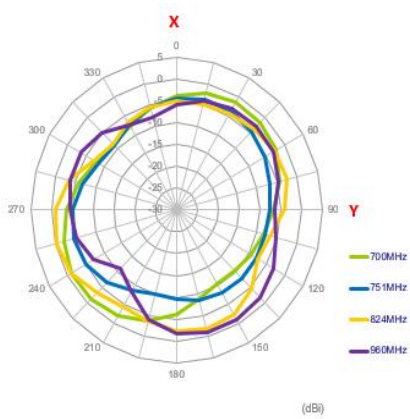

1710MHz

2170MHz

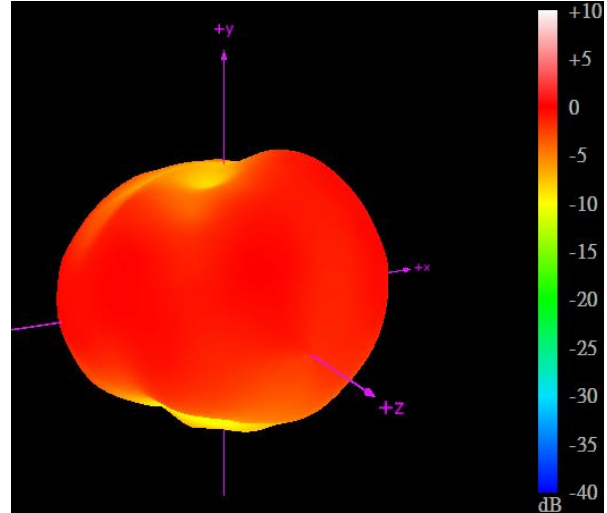
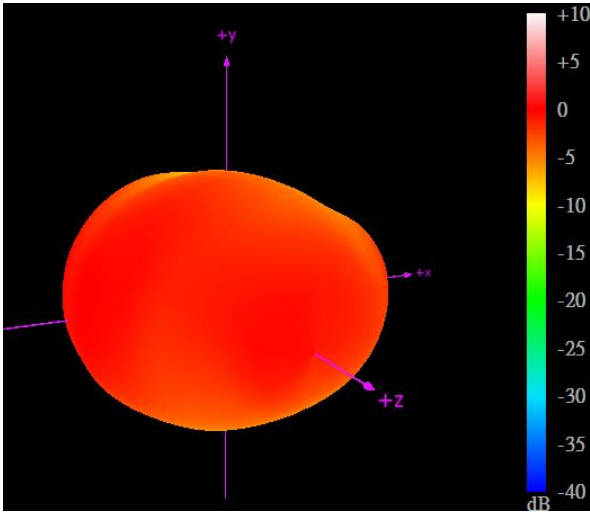

XY Plane

XZ Plane

YZ Plane

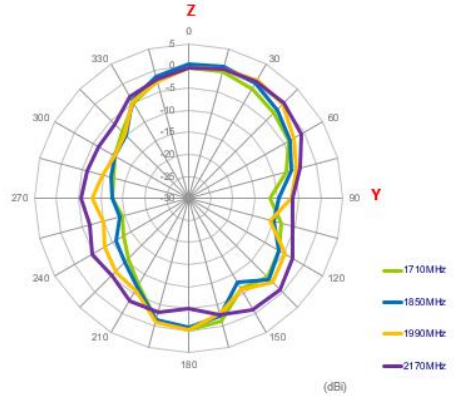
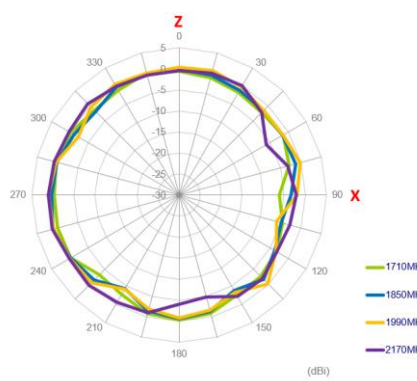
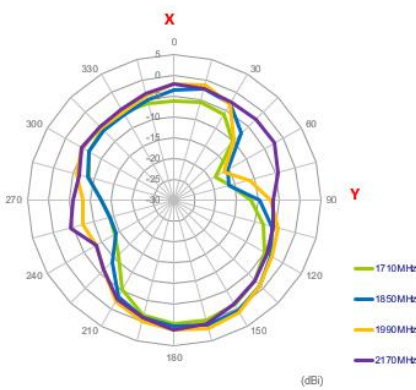

2500MHz

2690MHz

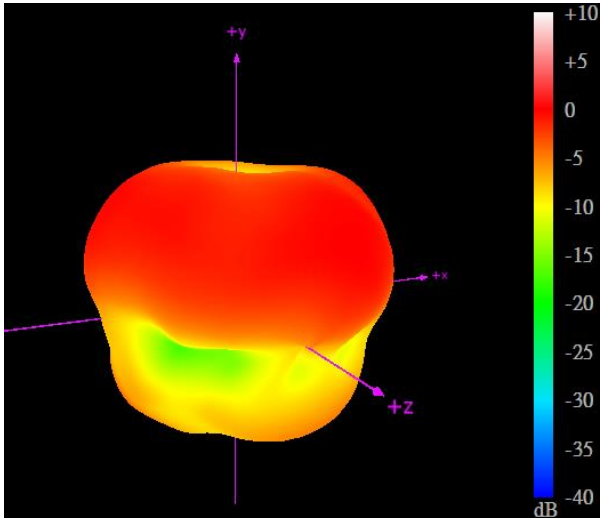
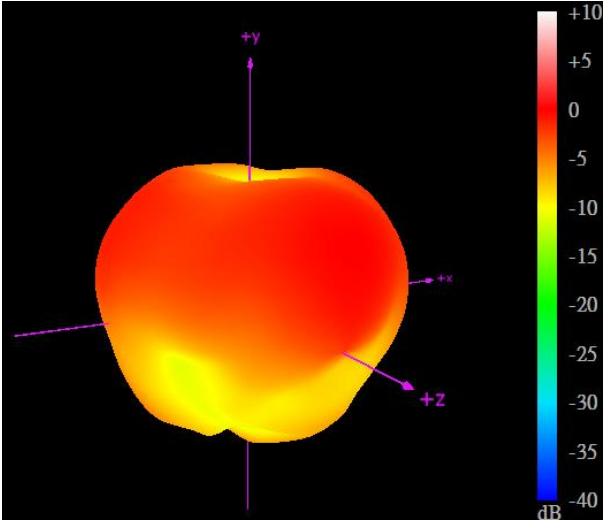

XY Plane

XZ Plane

YZ Plane

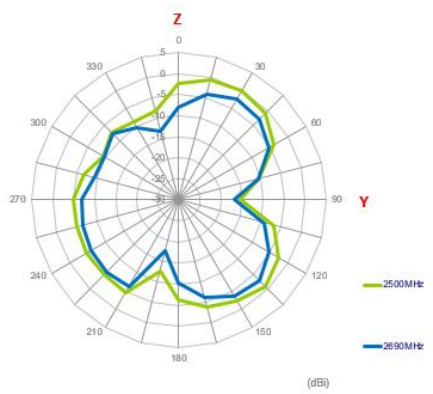
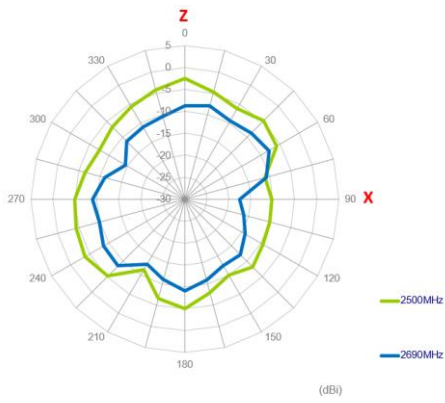
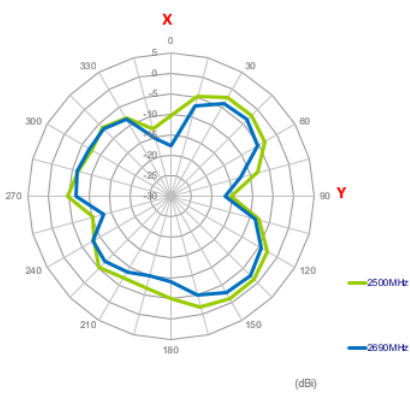

4.3 3D and 2D Radiation Patterns – 30*30cm Ground Plane

704MHz

960MHz

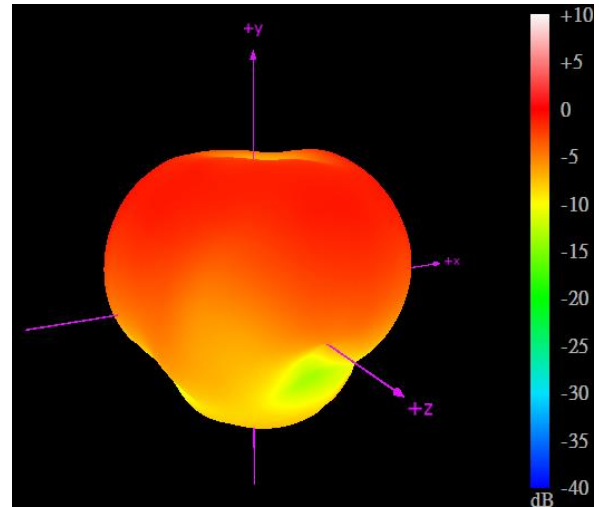
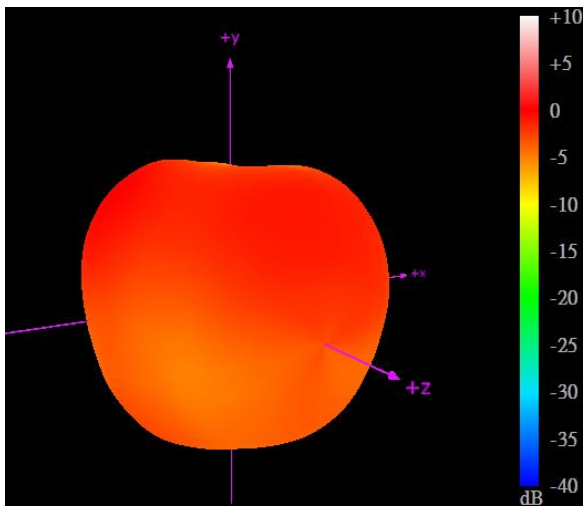

XY Plane

XZ Plane

YZ Plane

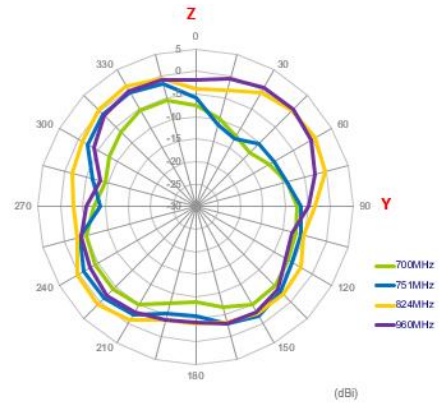
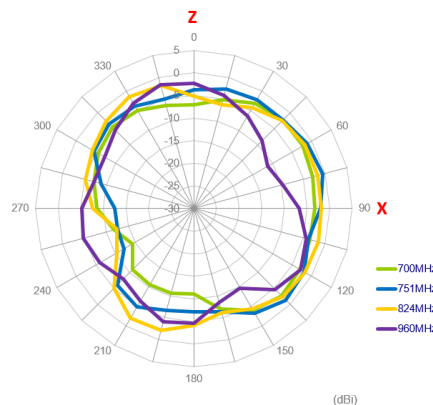
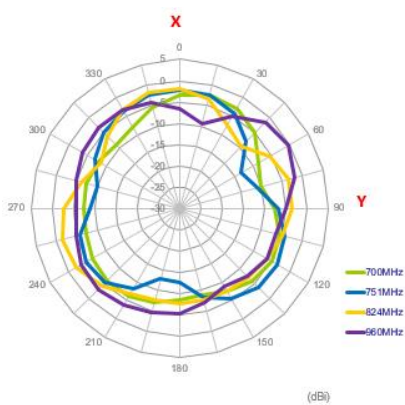

1710MHz

2170MHz

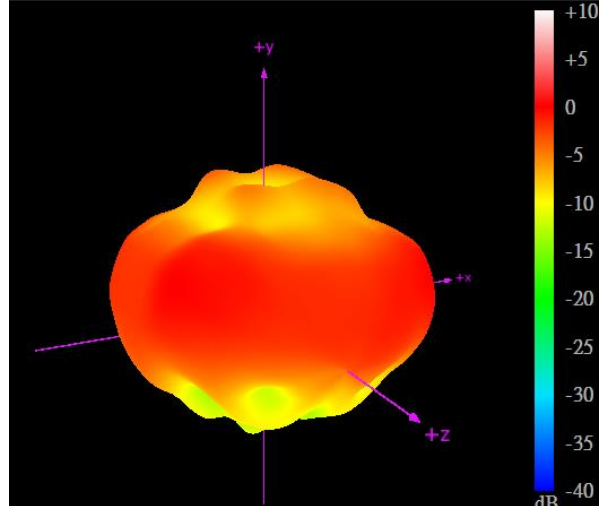
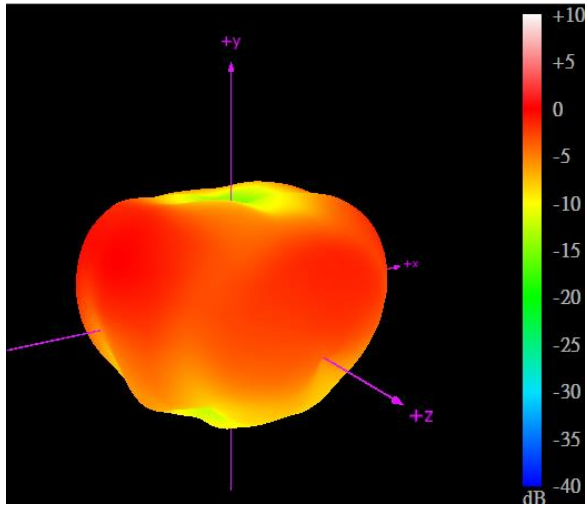

XY Plane

XZ Plane

YZ Plane

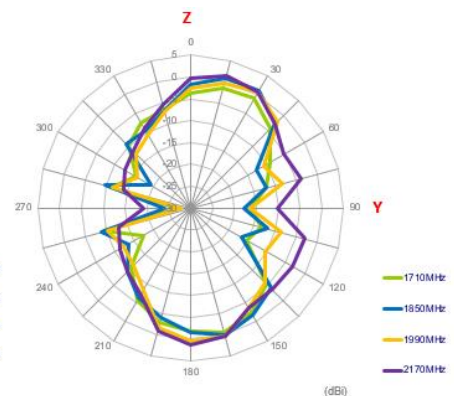
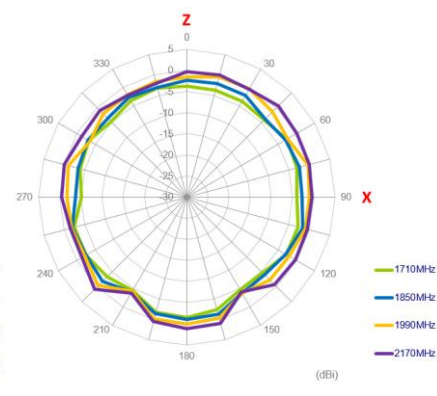
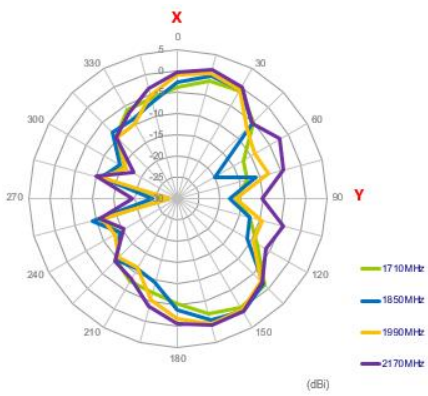

2500MHz	2690MHz
----------------	----------------

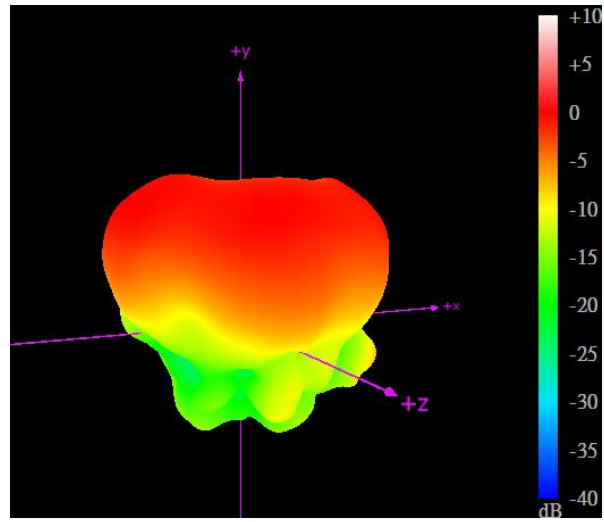
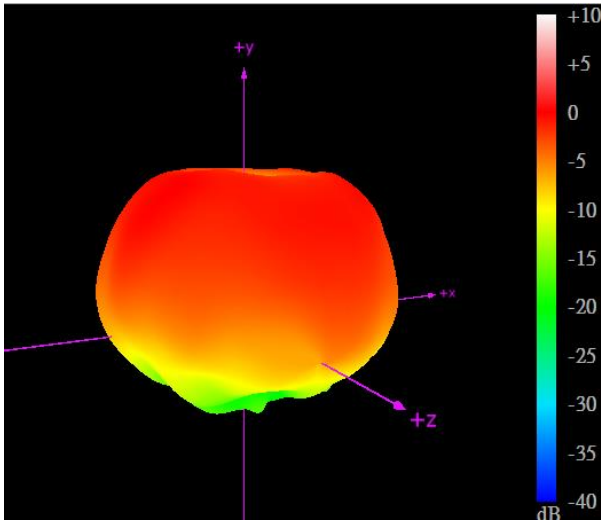

XY Plane	XZ Plane	YZ Plane
-----------------	-----------------	-----------------

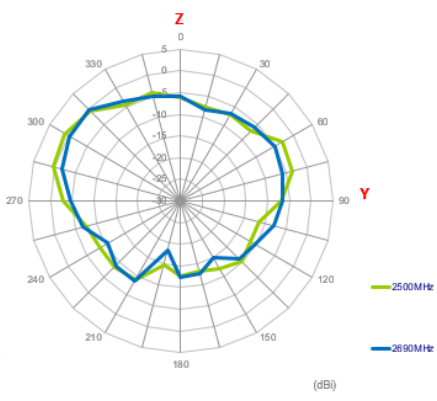
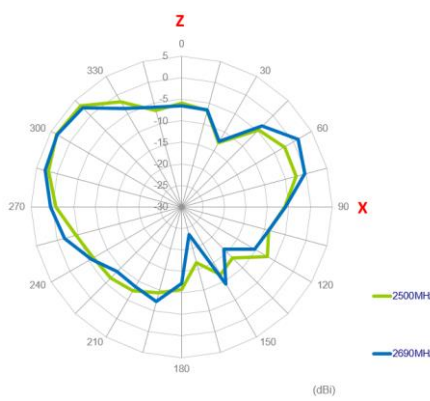
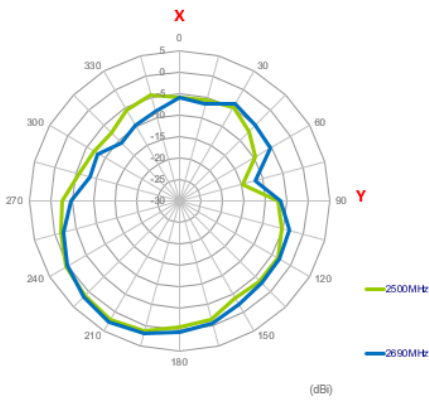

5. Mechanical Drawing (Units: mm)

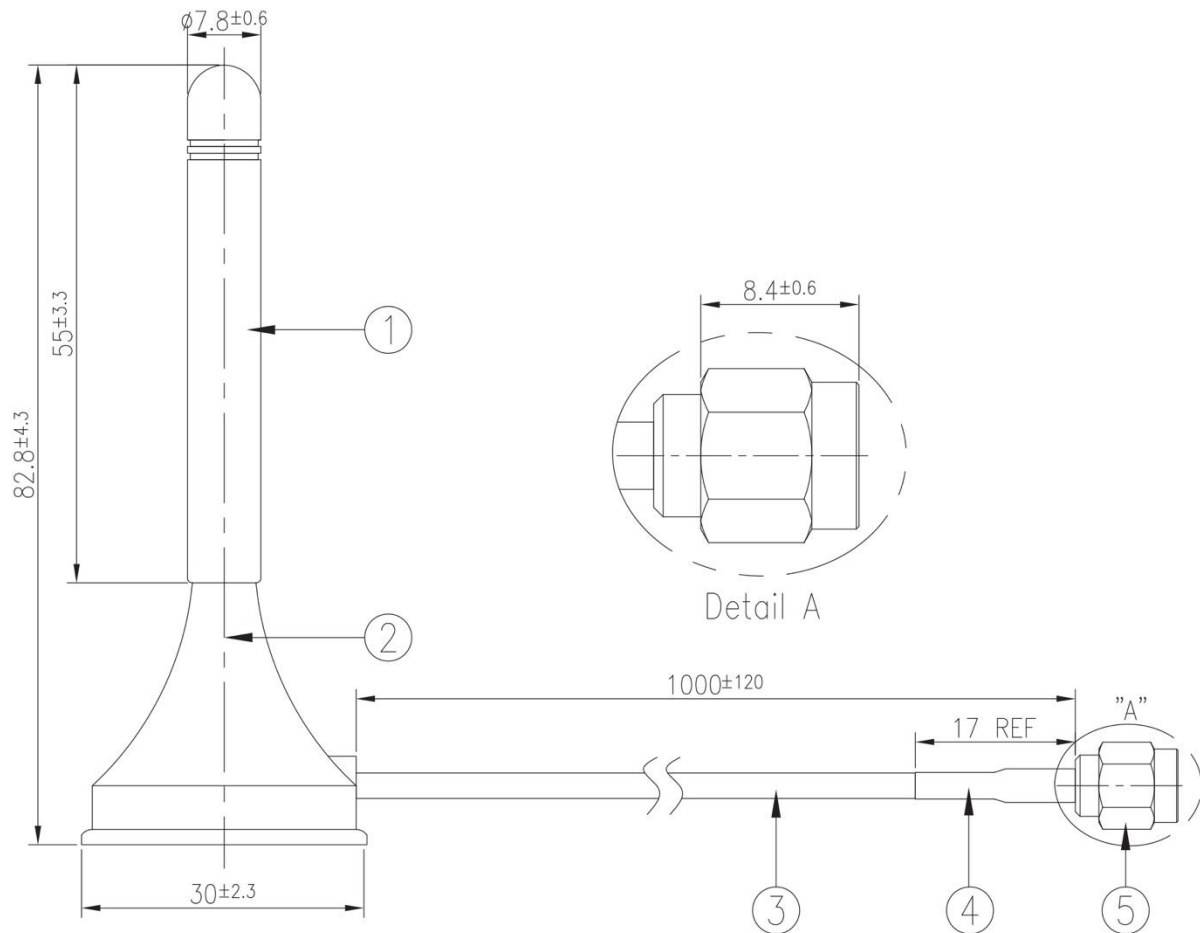

	Name	Material	Finish	QTY
1	GA.111 Antenna Housing	TPEE	Black	1
2	GA.111 Antenna Bottom	ABS	Black	1
3	RG174 Coaxial Cable	PVC	Black	1
4	Heat Shrink Tube	EVA	Black	1
5	SMA(M)ST	Brass	Au Plated	1

6. Magnetic Pull Force

Item No./Part No.	Magnetic force test Result	PASS/FAIL
Sample A(magnet type:N40)	2.8>1KGf	PASS
Sample B(magnet type:N40)	2.0>1KGf	PASS



7. Packaging

1pc GA.111.101111 in small in Anti-static Bag
 Dimensions - 100*180mm
 Weight - 32g

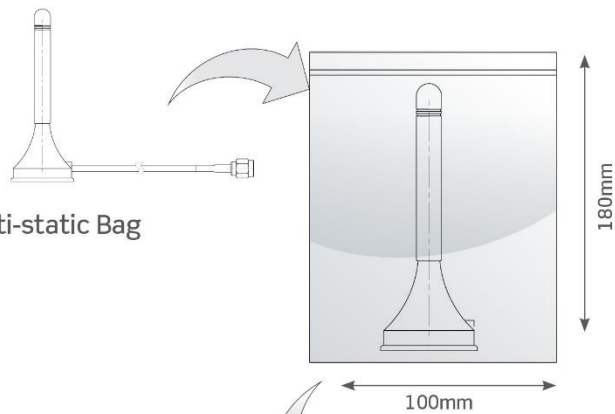

50 PE bags per large PE bags
 50 pcs GA.111.101111 per large PE bags
 Large PE bags Dimensions - 360 x 520mm
 Weight - 1.6kg

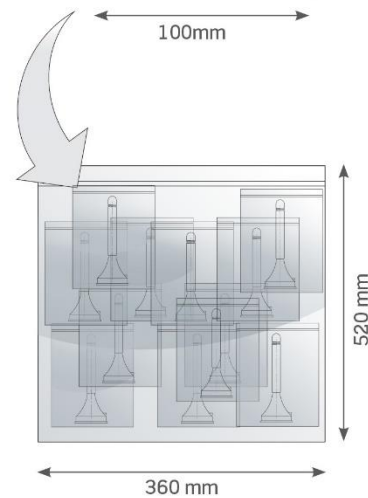

5 Large PE bags per carton
 250 pcs GA.111.101111 per carton
 Carton Dimensions - 490 x 360 x 260mm
 Weight - 8.3kg

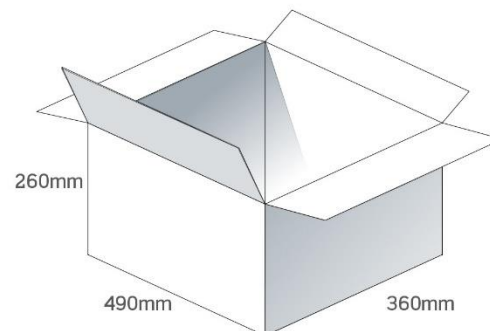

Pallet Dimensions 1200*1000*1500mm
 20 Cartons per Pallet
 4 Cartons per layer
 5 Layers

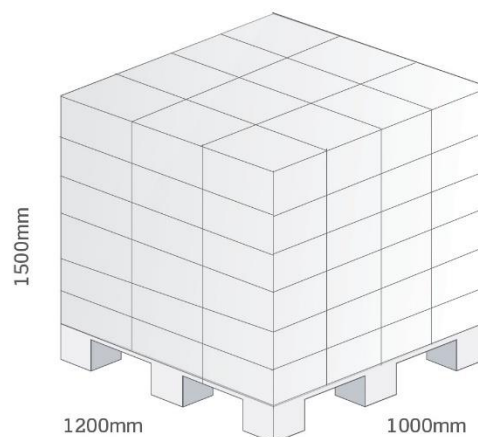

8. Application Note

The GA.111 antenna performance with different cable lengths is shown below.

8.1 Return Loss

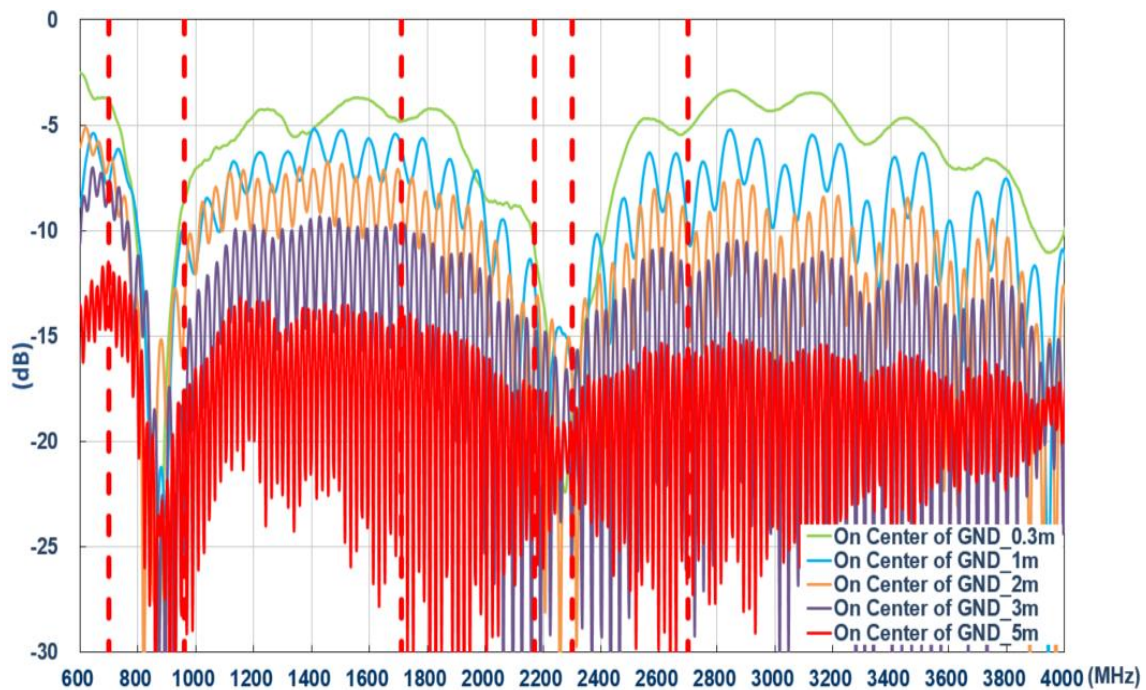
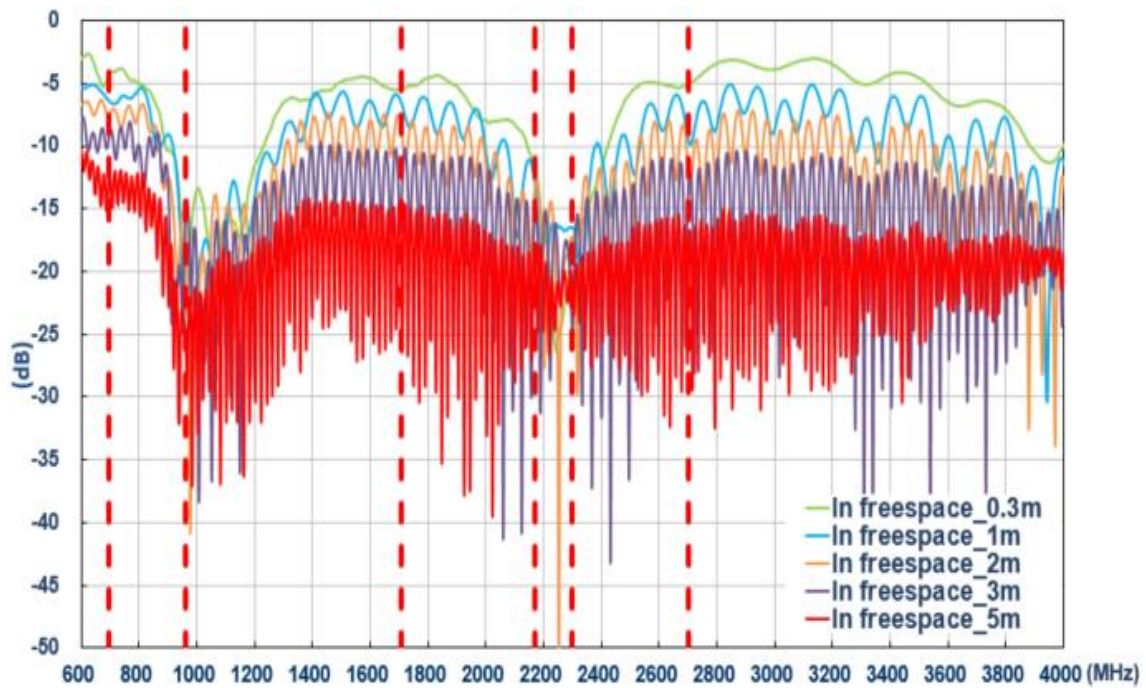

8.2 Efficiency

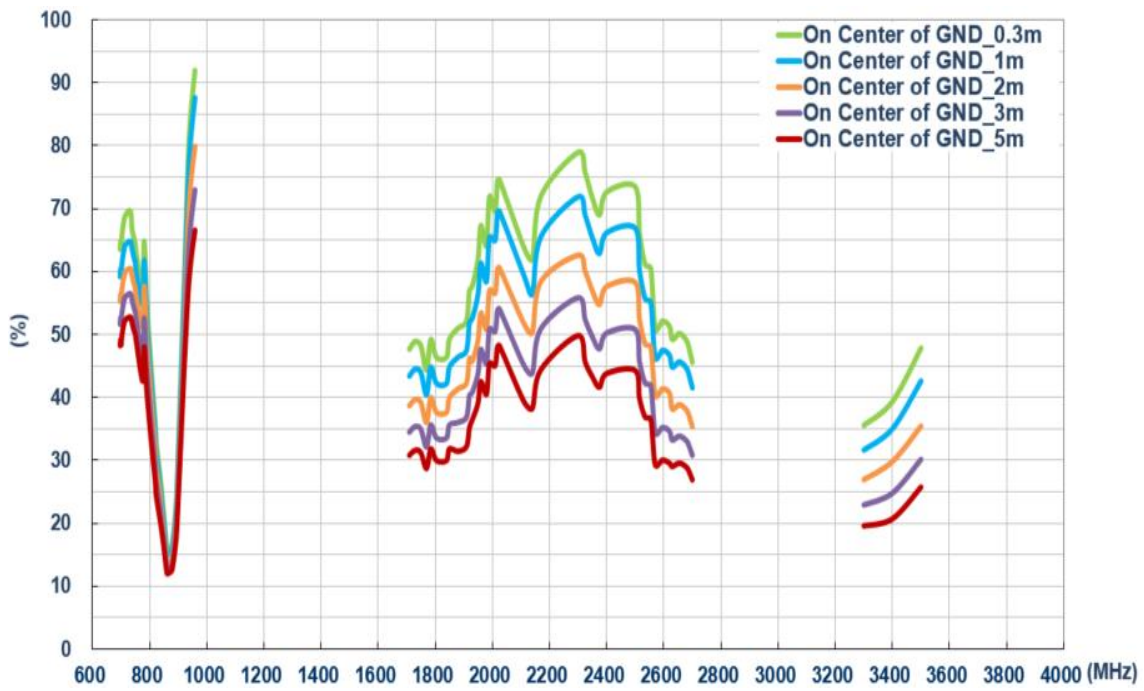
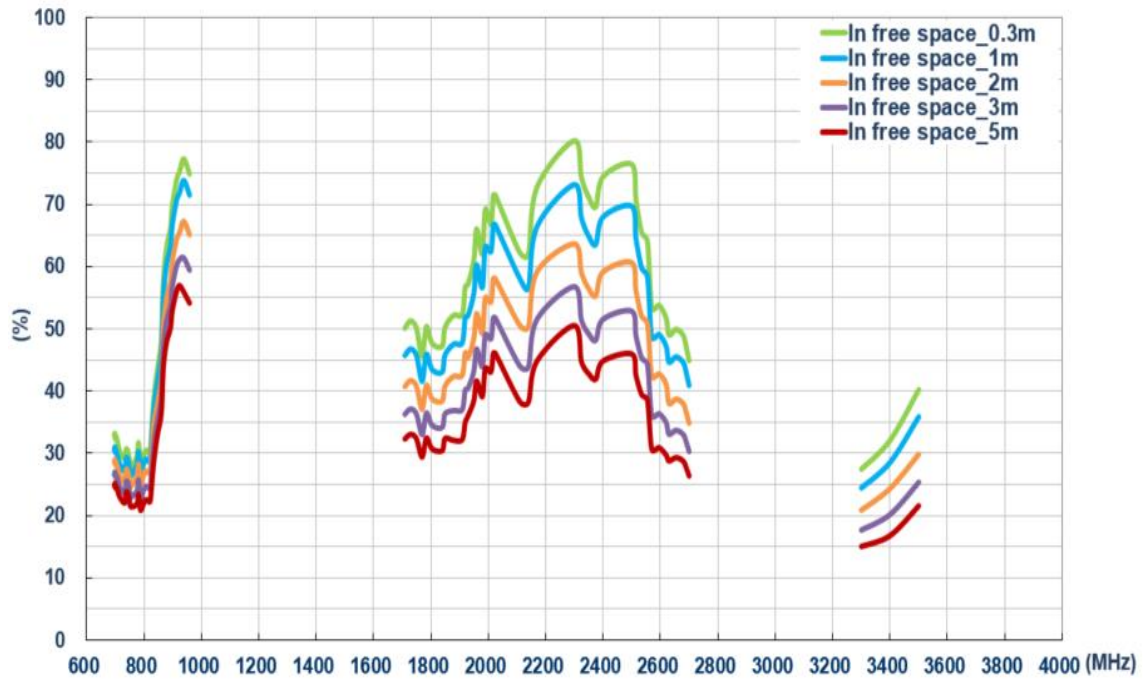

8.3 Average Gain

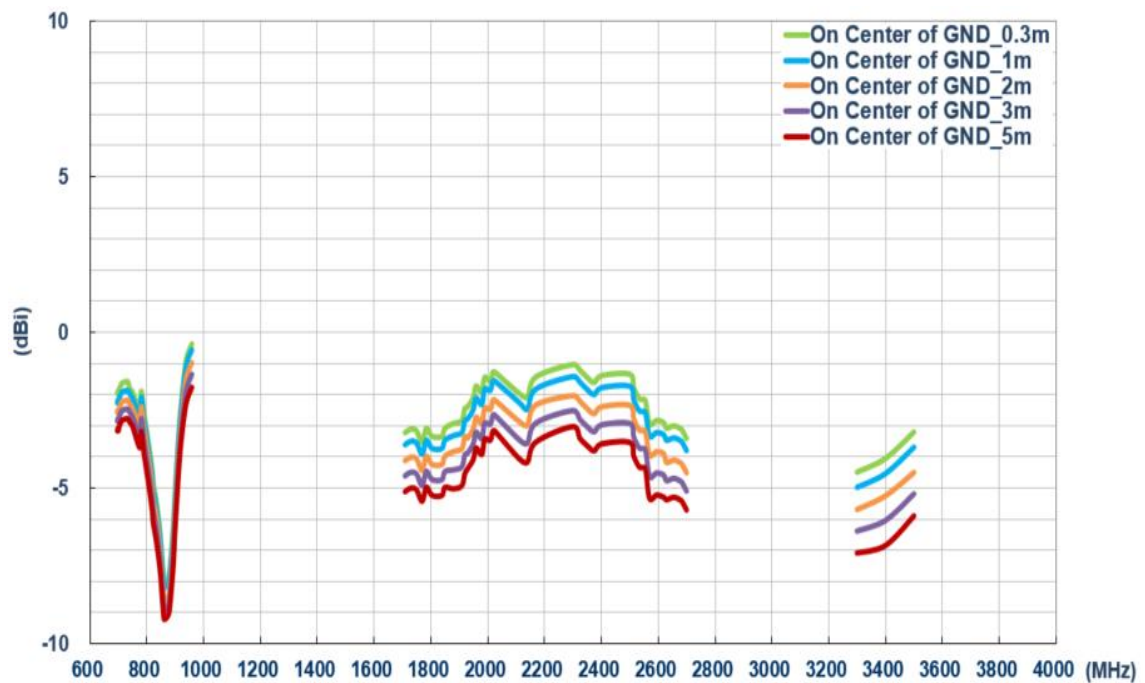
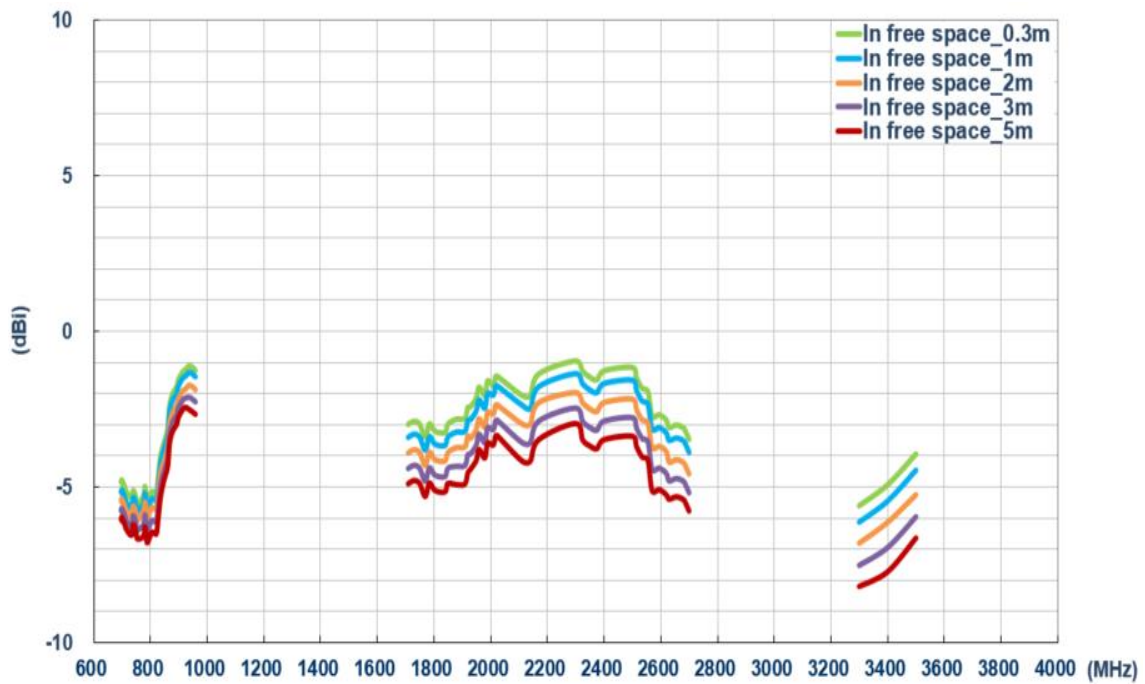

8.4 Peak Gain

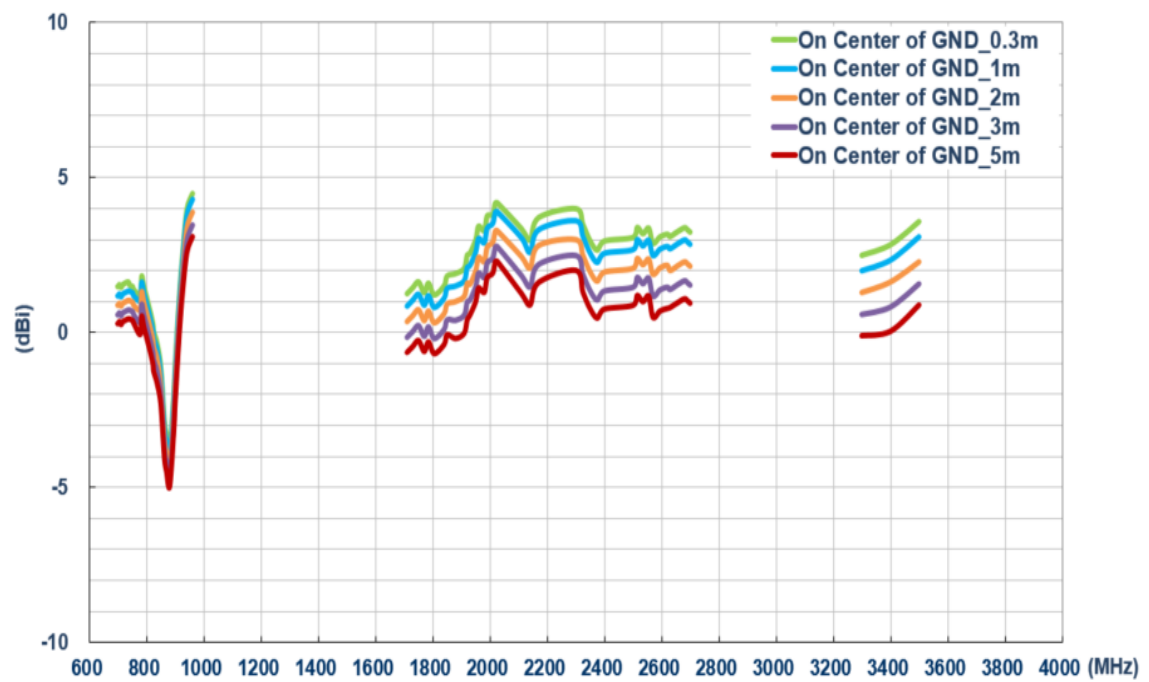
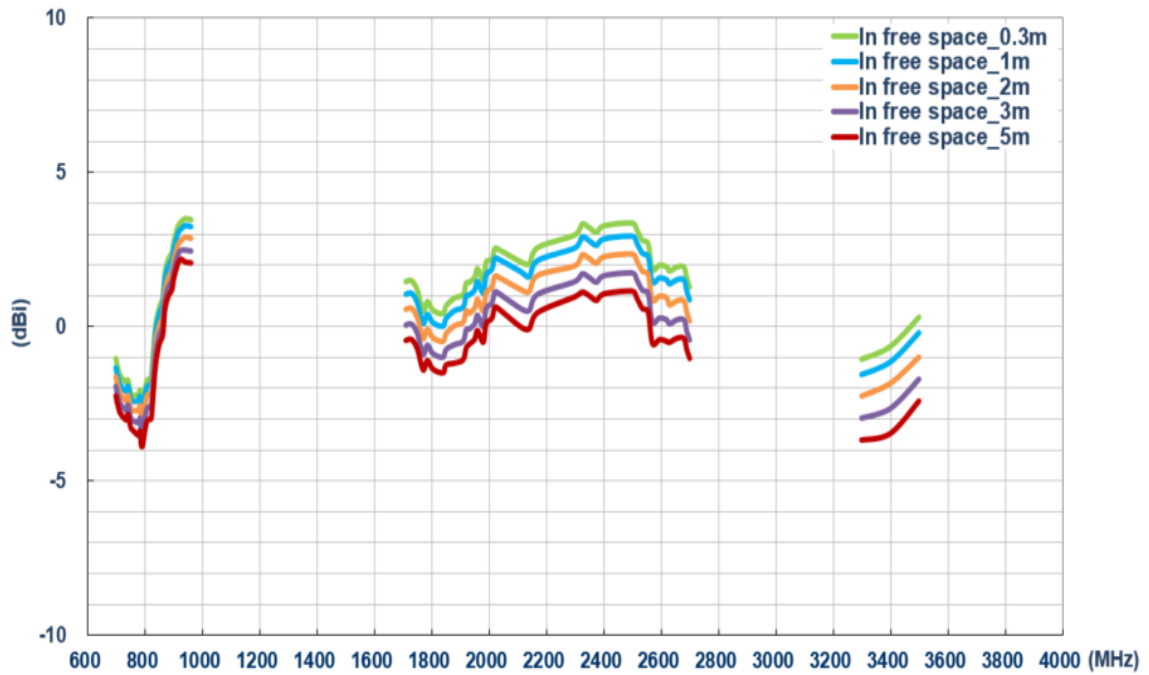

Changelog for the datasheet

SPE-17-8-092 – GA.111.101111

Revision: B (Current Version)

Date:	2020-05-12
Changes:	Updated Template
Changes Made by:	Jack Conroy

Previous Revisions

Revision: A (Original First Release)

Date:	2017-12-18
Notes:	
Author:	Jack Conroy



TAOGLAS®

www.taoglas.com

