



GDS 207 schwarz/black

Industrial Connectors:Rectangular connectors GDM-series:Type C Industrial
Standard:Cable socket

Product description

Description	cable socket with central screw M 3 x 28
Type	GDS 207 schwarz/black
Order No.	933 138-100
Other standard types	grey housing, Order No. 933 138-106
Number of contacts	2 + PE
Cable gland	PG 7
Conductor size	max. 0.75 mm ²
Standard	industrial standard (9.4 mm)
Housing Color	black
Construction type	C

Drawing

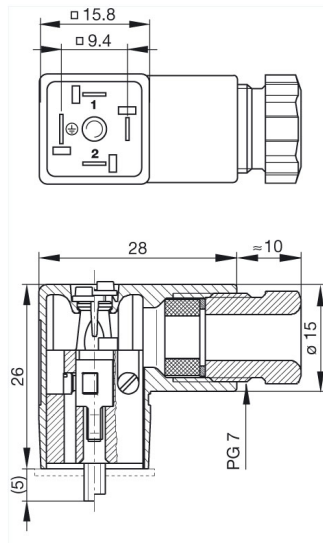

Technical data

Pin dimensions	2,8 mm x 0,5 mm, 3,6 mm x 0,5 mm
Rated voltage	UC 250 V
Rated current	6 A
Contact resistance	<= 4 mOhm
Type of termination	screw
Suitable cables	4.5 mm to 6 mm diameter
Mounting	central screw

Material

Contact surface material	Sn
Contact bearer material	PA
Housing material	PA

Environmental conditions

Protection class (IEC 60529)	IP 65
Pollution severity	3

Temperature range	-40 °C to +125 °C
Inflammability class	
Housing	94 HB
Contact bearer	94 V-2
Approvals	
UR	UR
VDE	VDE
SEV	SEV
CSA	CSA
Packaging unit	
Packaging unit	200 pieces
Scope of delivery and accessories	
Accessories to order separately	(NBR) flat gasket GDS 307-2, Order No. 730 185-002; (EPDM) flat gasket GDS 307-4, Order No. 730 314-004