

REAR INSULATINGPLATE BROADENED 1 PCS.
ACCESSORY FOR: 3VA2 400/630



Figure similar

Model

product brand name SENTRON

General Product Approval	EMC	Declaration of Conformity	other
--------------------------	-----	---------------------------	-------



[other](#)



EG-Konf.

[other](#)

Further information

Information- and Downloadcenter (Catalogs, Brochures,...)

<http://www.siemens.com/lowvoltage/catalogs>

Industry Mall (Online ordering system)

<https://eb.automation.siemens.com/mall/en/WW/Catalog/Product/3VA94810WK30>

Service&Support (Manuals, Certificates, Characteristics, FAQs,...)

<http://support.automation.siemens.com/WW/view/en/3VA94810WK30/all>

Image database (product images, 2D dimension drawings, 3D models, device circuit diagrams, ...)

http://www.automation.siemens.com/bilddb/cax_en.aspx?mlfb=3VA94810WK30

CAX-Online-Generator

<http://www.siemens.com/cax>

Tender specifications

<http://ausschreibungstexte.siemens.com/tiplv>

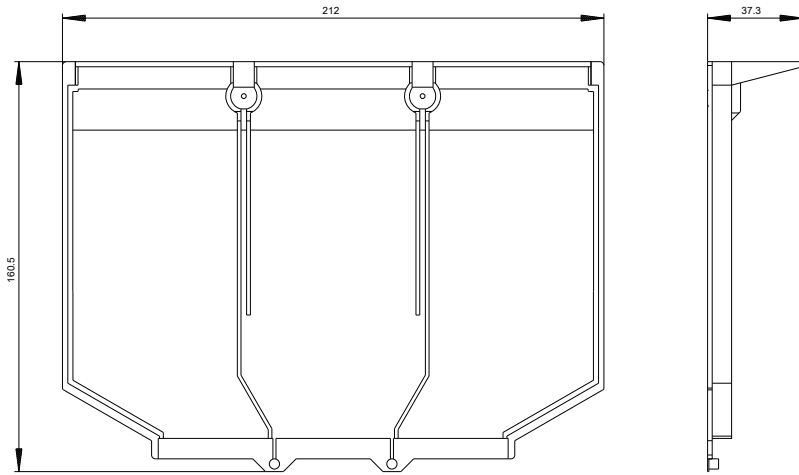

last modified:

11.03.2015