

BD2-AK02X/F2258-3 TAP-OFF UNIT 63A / 1X 3POLE
FUS E SOCKET SP58

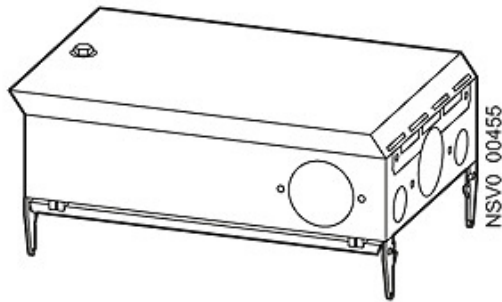

Model		
Product designation		tap-off unit for BD2 busbar trunking system
Protection class		
Protection class IP		IP54
Main circuit		
Operating frequency / Rated value		
• minimum	Hz	50
• maximum	Hz	60
Operating voltage / with AC		
• at 50 Hz / Rated value / maximum	V	400
• at 60 Hz / Rated value / maximum	V	400
Operating current		
• for circuit 1 / with AC / at 50 Hz / Rated value / maximum	A	63
• for circuit 1 / with AC / at 60 Hz / Rated value / maximum	A	63
Connections		
Connectable conductor cross-section / in the outgoing unit		
• minimum	mm ²	0.75
• maximum	mm ²	25
Tap-off points		
Outgoing unit version		cable entry

Design of short-circuit and overloading protection / in the outgoing unit		3-pole fuse base for three 22x58 mm cylinder fuses
Size of the outgoing feeder		02
Number of poles / of the outgoing feeder		5

Mechanical Design

Height	mm	160
Width	mm	214
Length	mm	331
Number of width units		8
Product component / Locking mechanism		Yes

General Product Approval



Further information

Information- and Downloadcenter (Catalogs, Brochures,...)

<http://www.siemens.com/lowvoltage/catalogs>

Industry Mall (Online ordering system)

<https://eb.automation.siemens.com/mall/en/WW/Catalog/Product/BVP:262473>

Service&Support (Manuals, Certificates, Characteristics, FAQs,...)

<http://support.automation.siemens.com/WW/view/en/BVP:262473/all>

Image database (product images, 2D dimension drawings, 3D models, device circuit diagrams, ...)

http://www.automation.siemens.com/bilddb/cax_en.aspx?mfb=BVP:262473

CAX-Online-Generator

<http://www.siemens.com/cax>

Tender specifications

<http://ausschreibungstexte.siemens.com/tiplv>

last modified:

11.03.2015