

SNAP Isolated Analog Input Modules

Features

- Channel-to-channel isolation
- Rugged packaging and convenient pluggable wiring. Accepts 22 to 14 AWG wire.
- Factory calibrated; no user adjustment necessary
- Out-of-range indication
- Operating temperature -20 °C to 70 °C

Description

SNAP I/O isolated analog input modules provide two or more channels isolated from each other, thereby eliminating problems caused by ground loop currents. These isolated analog modules are part of Opto 22's SNAP PAC System and mount on SNAP PAC racks with an I/O processor (brain or on-the-rack controller). SNAP isolated analog input modules are compatible with all SNAP PAC brains and rack-mounted controllers, including Wired+Wireless™.

Since many SNAP analog input modules are software-configurable and handle a wide variety of signal levels, a small number of modules can support a wide range of input requirements. Modules provide high resolution for precise signal levels, and all SNAP analog modules are factory calibrated. Part numbers ending in -FM are Factory Mutual approved. Dimensional drawings start on page 14.

SNAP analog input modules have an on-board microprocessor to provide module-level intelligence, making them an ideal choice for original equipment manufacturers (OEMs). For more information about standalone SNAP analog modules, see the *SNAP I/O Module Integration Guide* (form 876).

SNAP racks use a retention rail locking system that holds modules in place. In addition, Opto 22 recommends using two 4-40 by 1/2-inch standard machine screws to secure each module to the rack (recommended torque: 4 inch pounds [0.45 Newton meters]).

Notes for legacy hardware: Most isolated analog input modules can be used with SNAP Simple, SNAP Ethernet, SNAP Ultimate, and SNAP *mistic* brains such as the serial B3000, and with M-series or B-series mounting racks. For exceptions, see individual module descriptions.

Isolation

All SNAP analog input modules are isolated from all other modules and from the I/O processor. In addition, the modules in this data sheet have all channels isolated from each other.



SNAP Isolated Analog Input Modules

Channel-to-channel isolation gives you complete freedom from ground-loop problems even on grounded devices connected to channels on the same module.

Transformer isolation prevents ground loop currents from flowing between field devices and causing noise that produces erroneous readings. Ground loop currents are caused when two grounded field devices share a connection, and the ground potential at each device is different.

Isolation also provides protection for sensitive control electronics from industrial field signals.

Part Numbers

Part	Description	Pg
SNAP-AIARMS-i SNAP-AIARMS-i-FM*	Isolated two-channel 0 to 10 amp RMS AC/DC input	2
SNAP-AIVRMS-i SNAP-AIVRMS-i-FM*	Isolated two-channel 0 to 250 V RMS AC/DC input	3
SNAP-AIMA-i	Isolated two-channel analog current input -20 mA to +20 mA	4
SNAP-AIMA-iSRC SNAP-AIMA-iSRC-FM*	Isolated two-channel analog current input -20 mA to +20 mA, with loop sourcing	5
SNAP-AIMA2-i	Isolated two-channel analog current input -1 mA to +1 mA	6
SNAP-AIRATE-HFi	Isolated two-channel analog frequency input, 2 Hz to 500 kHz or 20 Hz to 500 kHz	7
SNAP-AITM-i	Isolated two-channel analog type E, J, or K thermocouple or ±150 mV or ±75 mV input	9
SNAP-AITM2-i	Isolated two-channel analog type B, C, D, G, N, T, R, or S thermocouple or ±50 mV or ±25 mV input	10
SNAP-AITM-4i	Isolated four-channel analog type B, C, D, E, G, J, K, N, R, S, or T thermocouple or ±150 mV, ±75 mV, ±50 mV, or ±25 mV input	11
SNAP-AIV-i	Isolated two-channel analog voltage input ±10 VDC or ±5 VDC	12
SNAP-AIV2-i	Isolated two-channel analog voltage input ±100 VDC or ±50 VDC	13

* Factory Mutual approved

SNAP Isolated Analog Input Modules

Isolated 0 to 10 Amp RMS AC/DC Input Module

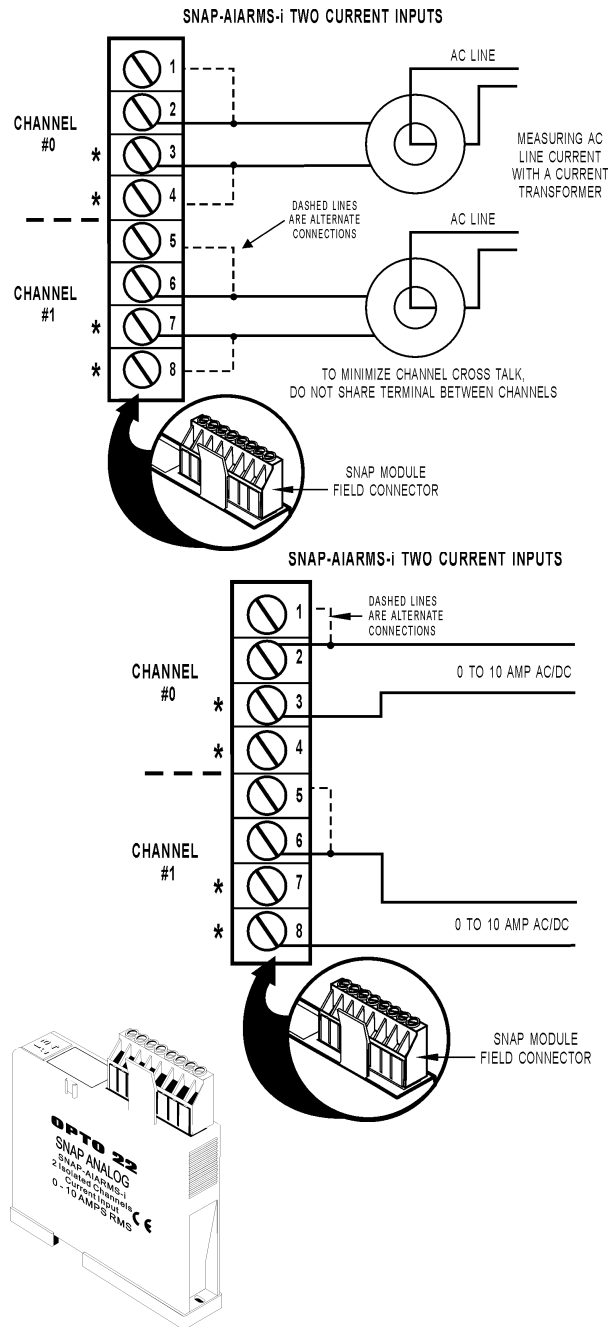

IMPORTANT: The mounting rack connector has 24 pins; the module connector has 20 pins. The extra pins on the mounting rack connector prevent misalignment of the module during installation.

Part Number	Description
SNAP-AIARMS-i	Isolated two-channel 0 to 10 amp RMS AC/DC input
SNAP-AIARMS-i-FM	

Description

The SNAP-AIARMS-i and SNAP-AIARMS-i-FM modules provide an input range of 0 to 10 amps RMS AC/DC. An ideal input is the 5-amp secondary of a standard current transformer used to monitor AC line current. These modules may also be used to monitor AC current to greater than a 100-amp range, using a current transformer of suitable ratio. The SNAP-AIARMS-i-FM module is Factory Mutual approved.

The two channels are isolated from each other; they do not share any field connection. These modules are ideal for differential current measurements.

Specifications

Input Range	0 to 10 amp RMS AC/DC
Input Over Range	To 11 amps
Input Resistance	0.005 ohms
Maximum Input	11 amps AC/DC
Accuracy (AC)	±8 mA and ±0.2% reading
Resolution	400 µA
DC Reversal	±16 mA (0.16%)
Input Response Time (Step Change)	63.2% (6.32 A) in 50 ms 99% (9.92 A) in 75 ms
Data Freshness (Max)	0.025 ms
DC Common Mode Rejection	>-120 dB
AC Common Mode Rejection	>-120 dB at 60 Hz
Maximum Operating Voltage Between Channels Common Mode Voltage	250 V 250 V
Isolation: Optical	4000 V
Isolation: Transformer	1500 V
Isolation: Channel to Channel	250 V continuous (1500 V transient)
Power Requirements	5 VDC (±0.15 V) at 200 mA
Ambient Temperature: Operating Storage	-20 °C to 70 °C -40 °C to 85 °C
Torque, hold-down screws	4 in-lb (0.45 N-m)
Torque, connector screws	5.26 in-lb (0.6 N-m)
Wire size range	22 to 14 AWG
Agency Approvals	CE, RoHS, DFARS FM (SNAP-AIARMS-FM only)
Warranty	Lifetime

SNAP Isolated Analog Input Modules

Isolated 0 to 250 Volt RMS AC/DC Input Module

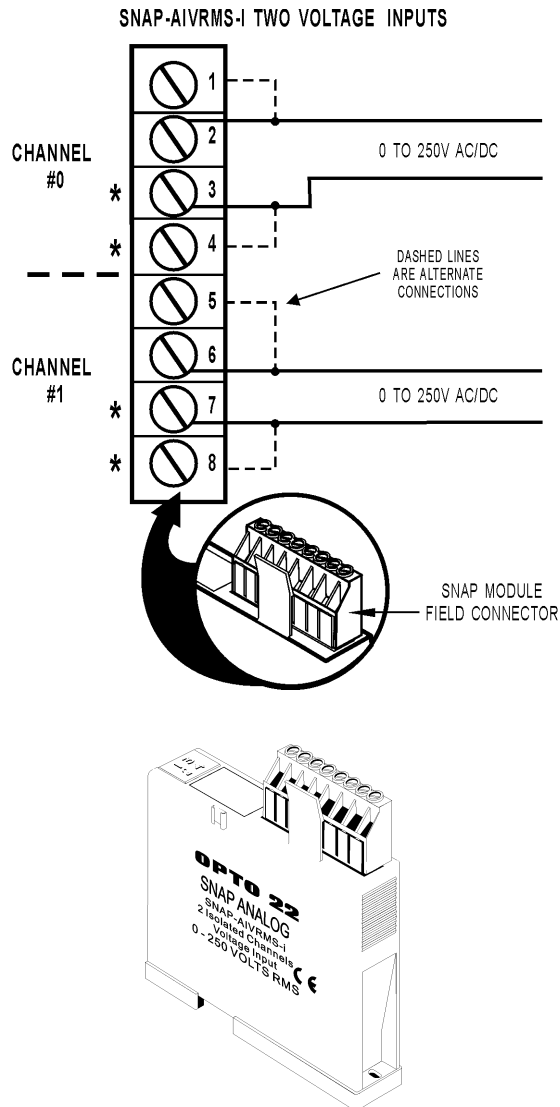

IMPORTANT: The mounting rack connector has 24 pins; the module connector has 20 pins. The extra pins on the mounting rack connector prevent misalignment of the module during installation.

Part Number	Description
SNAP-AIVRMS-i	Isolated two-channel 0 to 250 V RMS AC/DC input
SNAP-AIVRMS-i-FM	Isolated two-channel 0 to 250 V RMS AC/DC input

Description

The SNAP-AIVRMS-i and SNAP-AIVRMS-i-FM modules provide an input range of 0 to 250 volts AC or DC. These modules may be used to monitor 120/240-volt AC/DC and 12/24/48-volt AC/DC system voltage. The SNAP-AIVRMS-i-FM module is Factory Mutual approved.

The two channels are isolated from each other; they do not share any field connection. These modules are ideal for differential voltage measurements.

Specifications

Input Range	0 to 250 V RMS AC/DC
Input Over Range	To 275 V
Input Resistance	1 megohms
Accuracy	±0.2 V and ±0.2% reading
Resolution	10 mV
DC Reversal	± 0.2 V (0.08%)
Input Response Time (Step Change)	63.2% (158 V) in 50 ms 99% (248 V) in 75 ms
Data Freshness	25 ms
DC Common Mode Rejection	>-120 dB
AC Common Mode Rejection	>-120 dB @ 60 Hz
Maximum Operating Voltage Between Channels Common Mode Voltage	250 V 250 V
Isolation: Optical	4000 V
Isolation: Transformer	1500 V
Isolation: Channel to Channel	250 V continuous (1500 V transient)
Power Requirements	5 VDC (±0.15 V) at 200 mA
Ambient Temperature: Operating Storage	-20 °C to 70 °C -40 °C to 85 °C
Torque, hold-down screws	4 in-lb (0.45 N-m)
Torque, connector screws	5.26 in-lb (0.6 N-m)
Wire size range	22 to 14 AWG
Agency Approvals	CE, RoHS, DFARS
Warranty	Lifetime

SNAP Isolated Analog Input Modules

Isolated Current Input Module -20 mA to +20 mA

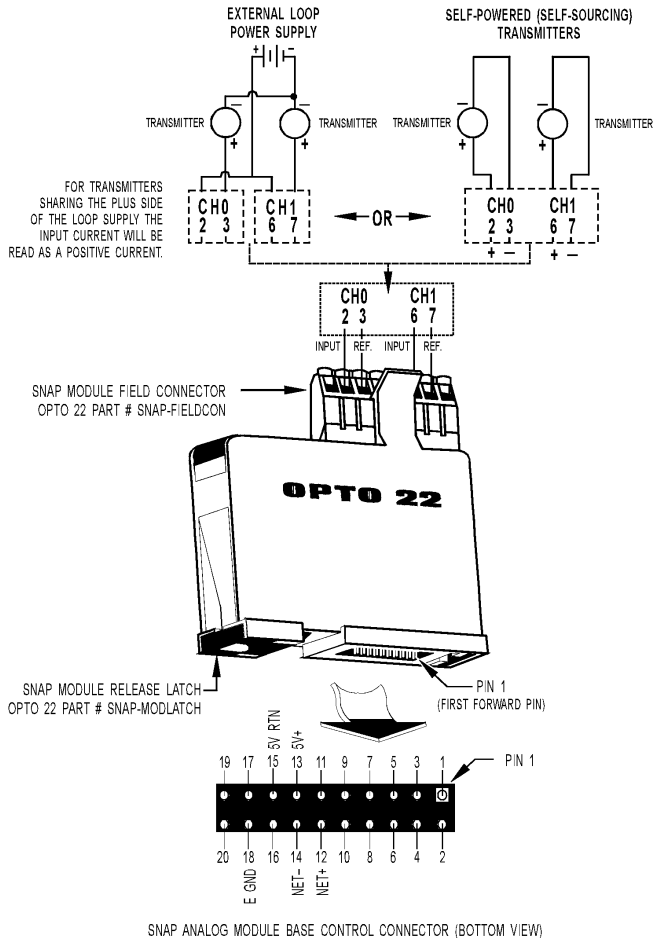

IMPORTANT: The mounting rack connector has 24 pins; the module connector has 20 pins. The extra pins on the mounting rack connector prevent misalignment of the module during installation.

Description

The SNAP-AIMA-i module provides an input range of -20mA to +20mA. The SNAP-AIMA-i has two channels that are isolated from each other. This module DOES NOT supply loop excitation current. See [page 5](#) for a loop sourcing model.

Part Number	Description
SNAP-AIMA-i	Isolated two-channel analog current input -20 mA to +20 mA

Specifications

Input Range	-20 mA to +20 mA
Maximum Over Range	± 10% (= ± 27500 counts)
Resolution	0.8 µA
Input Response Time (% of span/delta I/delta time)	99.9 %/19.9 µA/10 mS
Data Freshness	11 ms
DC Common Mode Rejection	>-120 dB
AC Common Mode Rejection	>-120 dB @ 60 Hz
Maximum Survivable Input	36 mA or 9 VDC
Maximum Operating Common Mode Voltage	250 V
Accuracy	0.05% (10 µA)
Isolation: Optical	4000 V
Isolation: Transformer	1500 V
Isolation: Channel to Channel	250 V continuous (1500 V transient)
DRIFT: Gain Temperature Coefficient	30 PPM/ °C
DRIFT: Offset Temperature Coefficient	15 PPM/ °C
Power Requirements	5 VDC (±0.15) @ 200 mA
Input Resistance - Single Ended	200 ohms (each channel)
Ambient Temperature: Operating Storage	-20 °C to 70 °C -40 °C to 85 °C
Torque, hold-down screws	4 in-lb (0.45 N-m)
Torque, connector screws	5.26 in-lb (0.6 N-m)
Wire size range	22 to 14 AWG
Agency Approvals	UL, CE, FM, RoHS, DFARS
Warranty	Lifetime

SNAP Isolated Analog Input Modules

Isolated Current Input Module -20mA to +20mA with Loop Sourcing

Specifications

Input Range	0 to +20 mA with loop sourcing -20 mA to +20 mA
Maximum Over Range	± 10% (= ± 27500 counts)
Resolution	0.8 µA
Input Response Time (% of span/delta I/delta time)	99.9 %/19.9 mA/10 ms
Data Freshness	11 ms
DC Common Mode Rejection	>-120 dB
AC Common Mode Rejection	>-120 dB @ 60 Hz
Maximum Survivable Input	36 mA or 9 VDC
Maximum Operating Common Mode Voltage	250 V
Accuracy	0.05% (10 µA)
DRIFT: Gain Temperature Coefficient	30 PPM/ °C
DRIFT: Offset Temperature Coefficient	15 PPM/ °C
Isolation: Optical	4000 V
Isolation: Transformer	1500 V
Isolation: Channel to Channel	250 V continuous (1500 V transient)
Power Requirements	5 VDC (±0.15) @ 200 mA
Power Requirements - Loop Power (Input)	From separate field connector: 24 VDC nominal (70 mA max @ 24 V input, both loops @ 20 mA), 30 VDC maximum
Loop Power (Output)	24 VDC (± 1.5 V) @ 20 mA Open loop: 30 V maximum Shorted loop: 24 mA nominal
LED on top of module	Indicates that there is power to the 24v source supply 2-pin connector
Input Resistance	200 ohms (each channel)
Ambient Temperature: Operating Storage	-20 °C to 70 °C -40 °C to 85 °C
Torque, hold-down screws	4 in-lb (0.45 N-m)
Torque, connector screws	5.26 in-lb (0.6 N-m)
Wire size range	22 to 14 AWG
Agency Approvals	CE, RoHS, DFARS FM (SNAP-AIMA-iSRC-FM only)
Warranty	Lifetime

Part Number	Description
SNAP-AIMA-iSRC SNAP-AIMA-iSRC-FM	Isolated two-channel analog current input -20 mA to +20 mA, with loop sourcing

Description

The SNAP-AIMA-iSRC and SNAP-AIMA-iSRC-FM are similar to the SNAP-AIMA-i module but include built-in loop sourcing capability. With the connection of a single 24 V power supply, these modules source 24 V for two 4–20 mA loops. The loops are internally connected to the individual inputs. The two channels and their loop sources are isolated from each other; they do not share any field connection. In addition, each loop source is current limited so that an external fault on one loop will not affect the other.

The SNAP-AIMA-iSRC-FM is Factory Mutual approved.

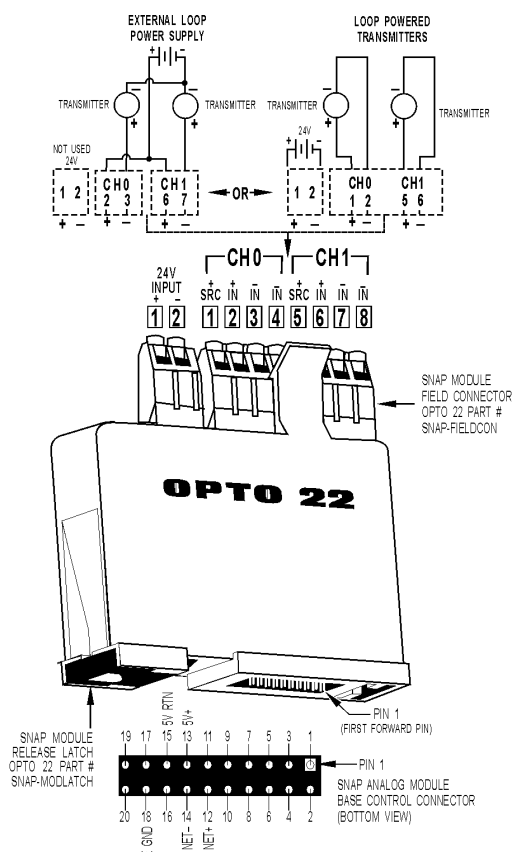

IMPORTANT: The mounting rack connector has 24 pins; the module connector has 20 pins. The extra pins on the mounting rack connector prevent misalignment of the module during installation.

SNAP Isolated Analog Input Modules

Isolated Current Input Module -1 mA to +1 mA

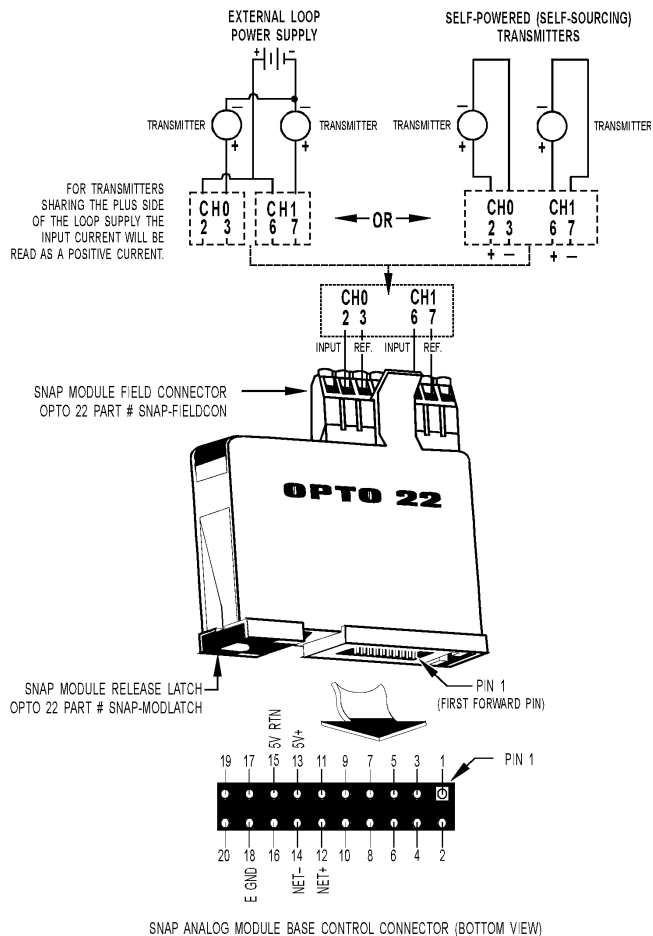

IMPORTANT: The mounting rack connector has 24 pins; the module connector has 20 pins. The extra pins on the mounting rack connector prevent misalignment of the module during installation.

Part Number	Description
SNAP-AIMA2-i	Isolated two-channel analog current input -1 mA to +1 mA

Description

The SNAP-AIMA2-i module provides an input range of -1 mA to +1 mA. The SNAP-AIMA2-i has two channels that are isolated from each other. This module DOES NOT supply loop excitation current.

Specifications

Input Range	-1 mA to +1mA
Maximum Over Range	± 10% (= ± 27500 counts)
Resolution	0.04 µA
Input Response Time (% of span/delta I/delta time)	99.9 %/19.9 µA/10 ms
Data Freshness	11 ms
DC Common Mode Rejection	>-120 dB
AC Common Mode Rejection	>-120 dB @ 60 Hz
Maximum Survivable Input	11 mA or 28 VDC
Maximum Operating Common Mode Voltage	250 V
Accuracy	0.05% (0.05 µA)
DRIFT: Gain Temperature Coefficient	30 PPM/ °C
DRIFT: Offset Temperature Coefficient	15 PPM/ °C
Isolation: Optical	4000 V
Isolation: Transformer	1500 V
Isolation: Channel to Channel	250 V continuous (1500 V transient)
Power Requirements	5 VDC (±0.15) @ 200 mA
Input Resistance	5 K ohms (each channel)
Ambient Temperature: Operating Storage	-20 °C to 70 °C -40 °C to 85 °C
Torque, hold-down screws	4 in-lb (0.45 N-m)
Torque, connector screws	5.26 in-lb (0.6 N-m)
Wire size range	22 to 14 AWG
Agency Approvals	CE, RoHS, DFARS
Warranty	Lifetime

SNAP Isolated Analog Input Modules

Isolated Frequency Input Module

Description

The SNAP-AIRATE-HFi module provides frequency to digital conversion. Each channel can be configured for a 0.1-second measurement interval, providing an input range of 20 Hz to 500 kHz, or a 1-second measurement interval, providing an input range of 2 Hz to 500 kHz. Data freshness is dependent upon and directly related to the measurement interval.

Nine volts through a 3.6 kOhm pull-up resistor is provided internally for each channel for use with devices that have open-collector outputs. This feature eliminates the need for you to provide the pull-up voltage supply and associated wiring, barrier strips, and so on. The module works with TTL, CMOS, and open-collector outputs.

The two channels on the module are isolated from each other. Since these channels do not share any common connections, grounded sensors and field devices may be used with them.

This module requires a SNAP PAC controller or brain with SNAP PAC firmware version 9.3c or higher. It cannot be used with legacy controllers or brains.

See wiring diagrams on the following page.



Part Number	Description
SNAP-AIRATE-HFi	Isolated two-channel analog frequency input, 2 Hz–500 kHz or 20 Hz–500 kHz

Specifications

Input Range	2 Hz - 500 kHz at 1.0 s Data Freshness 20 Hz - 500 kHz at 0.1 s Data Freshness
Input Voltage Range	3.0 V to 48 V _{p-p} Sine wave >= 2000 Hz 4.0 V to 48 V _{p-p} Sine wave at 200 Hz 5.0 V to 48 V _{p-p} Sine wave at 20 Hz 17 V to 48 V _{p-p} Sine wave at 2 Hz 3.0 V to 48 V _{p-p} Square wave 110 V _{p-p} Maximum survivable
Input Impedance	55 kOhms
Input Coupling	Single-ended AC
Pull-up Voltage	6 to 9 VDC
Pull-up Resistor	3.6 kOhm
Minimum Pulse Width	1 microsecond
Data Freshness*	100 ms at 20 Hz - 500 kHz 1.0 s at 2 Hz to 500 kHz
Resolution (Hz)	$f / (48,000,000 * \text{Data Freshness})$, where f is the current frequency measurement
Accuracy	+ 0.005% of input for input greater than 500 Hz. + 0.005% of input plus an additional +/- 0.1 Hz for input less than 500 Hz.
Maximum Operating Common Mode Voltage	250 V Continuous 1500 V Transient
DC Common Mode Rejection	> -120 dB
AC Common Mode Rejection	> -120 dB at 60 Hz
Isolation: Channel to Channel	250 V Continuous 1500 V Transient
Power Consumption	1.05 W (210 mA @ 5 V)
Ambient Temperature	-20 to 70 °C
Operating	-40 to 85 °C
Storage	
Torque, hold-down screws	4 in-lb (0.45 N-m)
Torque, connector screws	5.26 in-lb (0.6 N-m)
Wire size range	22 to 14 AWG
Agency Approvals	CE, RoHS, DFARS
Warranty	Lifetime

* User selectable. Default is 0.1 seconds.

SNAP Isolated Analog Input Modules

Isolated Frequency Input Module (cont'd)

SNAP-AIRATE-HFi Wiring Diagrams

The two channels on the module are isolated from each other. Since these channels do not share any common connections, grounded sensors and field devices may be used with them.

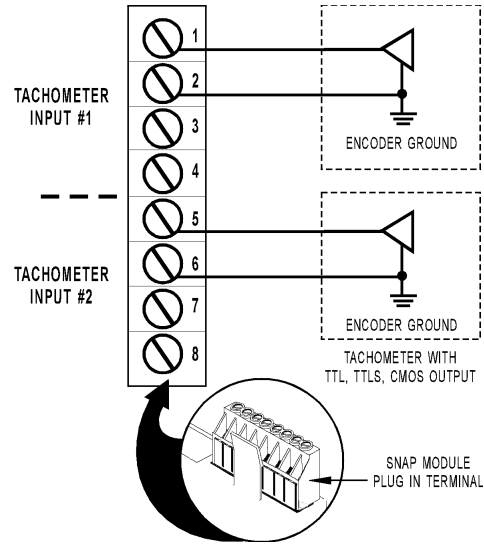
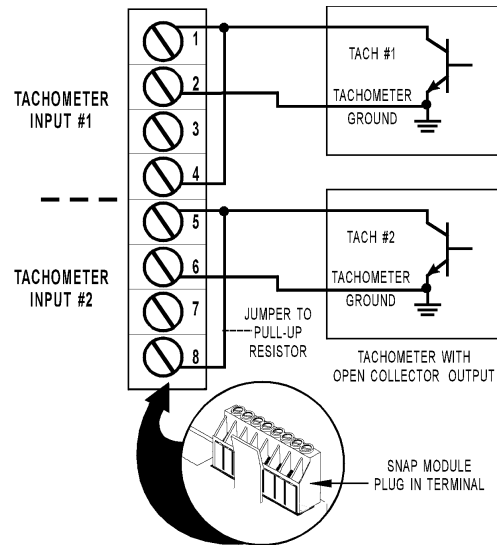

SNAP Isolated Analog Input Modules

Isolated Thermocouple/ Millivolt Input Module

Specifications

Input Range	From -150 mV to +150 mV From -75 mV to +75 mV
Maximum Over Range	± 10% (= ± 27500 counts)
Resolution	6 µV from -150 mV to +150 mV 3 µV from -75 mV to +75 mV
Cold Junction Temperature Compensation	Automatic when used with SNAP brains
Input Filtering	-3 dB @ 7 Hz
Input Response Time (% of span/delta V/delta time)	63.2%/95 mV/23 mS
Data Freshness	65 ms for +/- 150 mV 130 ms for +/- 75 mV 130 ms for E-, J-, and K-type thermocouples
DC Common Mode Rejection	>-120 dB
AC Common Mode Rejection	>-120 dB @ 60 Hz
Maximum Survivable Input	±15 volts
Maximum Operating Common Mode Voltage	250 V
Accuracy	0.06% (90 µV) @ 150 mV (full scale) 0.1% (75 µV) @ 75 mV (full scale)
Drift: Gain Temperature Coefficient	5 µV / °C
Drift: Offset Temperature Coefficient	2 µV / °C
Thermocouple Accuracy [°C] From factory After user gain and offset commands	± 2.0 (E, J, and K) ± 0.8
Isolation: Optical	4000 V
Isolation: Transformer	1500 V
Isolation: Channel to Channel	250 V continuous (1500 V transient)
Power Requirements	5 VDC (±0.15) @ 200 mA
Input Resistance	100 megohms (each channel)
Ambient Temperature: Operating Storage	-20 °C to 70 °C -40 °C to 85 °C
Torque, hold-down screws	4 in-lb (0.45 N-m)
Torque, connector screws	3 in-lb (0.34 N-m)
Wire size range	22 to 14 AWG
Agency Approvals	CE, FM, RoHS, DFARS
Warranty	Lifetime

Part Number	Description
SNAP-AITM-i	Isolated two-channel analog type E, J, or K thermocouple or -150 mV to +150 mV input or -75 mV to +75 mV input

Description

The SNAP-AITM-i module provides two channels of analog to digital conversion. Each channel on the module can be configured for -150 mV DC to +150 mV DC or -75 mV DC to +75 mV DC, or for type E, J, or K thermocouple operation. The two channels are isolated from each other. Since these channels do not share any common connections, grounded sensors and field devices may be used with them.

Type	-	+	Range
E	Red	Purple	-270 °C to +1,000 °C
J	Red	White	-210 °C to +1,200 °C
K	Red	Yellow	-270 °C to +1,372 °C

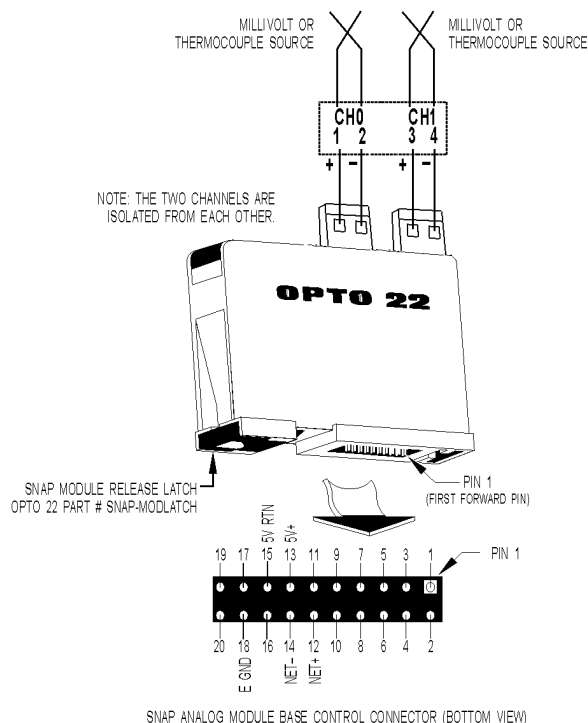

IMPORTANT: The mounting rack connector has 24 pins; the module connector has 20 pins. The extra pins on the mounting rack connector prevent misalignment of the module during installation.

SNAP Isolated Analog Input Modules

Isolated Thermocouple/ Millivolt Input Module

Type	-	+	Range
B	RED	GRAY	+42 °C to +1,820 °C
C, D, G	RED	WHITE	0 °C to +2,320 °C
N	RED	ORANGE	-270 °C to +1,300 °C
R, S	RED	BLACK	-50 °C to +1,768 °C
T	RED	BLUE	-270 °C to +400 °C

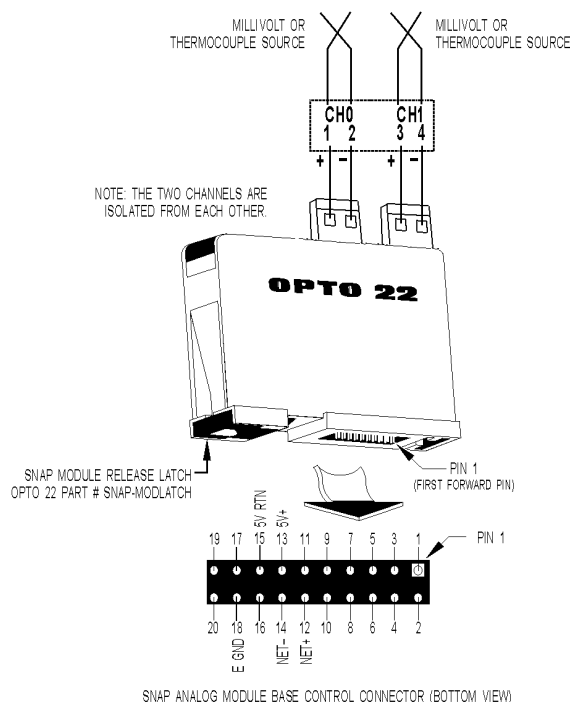

IMPORTANT: The mounting rack connector has 24 pins; the module connector has 20 pins. The extra pins on the mounting rack connector prevent misalignment of the module during installation.

Description

The SNAP-AITM2-i module provides an input range of ± 50 mV, ± 25 mV, or Type B, C, D, G, N, T, R, or S thermocouple.

The two channels on the module are isolated from each other. Since these channels do not share any common connections, grounded sensors and field devices may be used with them.

Part Number	Description
SNAP-AITM2-i	Isolated two-channel analog type B, C, D, G, N, T, R, or S thermocouple or -50 mV to +50 mVDC input or -25 mV to +25 mVDC input

Specifications

Input Range	From -50 mV to +50 mVDC From -25 mV to +25 mVDC
Maximum Over Range	$\pm 10\%$ (= ± 27500 counts)
Resolution	2 μ V from -50 mV to +50 mV 1 μ V from -25 mV to +25 mV
Cold Junction Temperature Compensation	Automatic when used with SNAP brains
Input Filtering	-3 dB @ 2.4 Hz
Input Response Time (% of span/delta V/delta time)	63.2%/31.5 mV/66 ms
Data Freshness	65 ms for +/- 50 mV 130 ms for +/- 25 mV 130 ms for B-, R-, S-, and T-type thermocouples 65 ms for C-, D-, G-, and N-type thermocouples
DC Common Mode Rejection	>-120 dB
AC Common Mode Rejection	>-120 dB @ 60 Hz
Maximum Survivable Input	± 15 volts
Maximum Operating Common Mode Voltage	250 V
Accuracy	0.1% (50 μ V) @ 50 mV (full scale) 0.2% (50 μ V) @ 25 mV (full scale)
Drift: Gain Temperature Coefficient	5 μ V / °C
Drift: Offset Temperature Coefficient	2 μ V / °C
Thermocouple Accuracy [°C]	B, R, S C, D, G T, N From factory ± 5 ± 4 ± 3 After user gain and offset commands ± 3 ± 2 ± 2
Isolation: Optical	4000 V
Isolation: Transformer	1500 V
Isolation: Channel to Channel	250 V continuous (1500 V transient)
Power Requirements	5 VDC (± 0.15) @ 200 mA
Input Resistance	100 megohms (each channel)
Ambient Temperature: Operating Storage	-20 °C to 70 °C -40 °C to 85 °C
Torque, hold-down screws	4 in-lb (0.45 N-m)
Torque, connector screws	3 in-lb (0.34 N-m)
Wire size range	22 to 14 AWG
Agency Approvals	CE, FM, RoHS, DFARS
Warranty	Lifetime

SNAP Isolated Analog Input Modules

Isolated Thermocouple/ Millivolt Input Module

Specifications

Input Range	From -150 mV to +150 mVDC From -75 mV to +75 mVDC From -50 mV to +50 mVDC From -25 mV to +25 mVDC			
Maximum Over Range	± 10% (= ± 27500 counts)			
Resolution	6 µV from -150 mV to +150 mV 3 µV from -75 mV to +75 mV 2 µV from -50 mV to +50 mV 1 µV from -25 mV to +25 mV			
Cold Junction Temperature Compensation	Automatic when used with SNAP PAC brains			
Input Filtering	-3 dB @ 5 Hz			
Data Freshness	mV input: 75 ms Thermocouple input: 140 ms			
DC Common Mode Rejection	>-120 dB			
AC Common Mode Rejection	>-120 dB @ 60 Hz			
Maximum Survivable Input	±15 volts			
Maximum Operating Common Mode Voltage	250 V			
Accuracy	0.06% (90 µV) @ 150 mV (full scale) 0.1% (75 µV) @ 75 mV (full scale) 0.1% (50 µV) @ 50 mV (full scale) 0.2% (50 µV) @ 25 mV (full scale)			
Drift: Gain Temperature Coefficient	5 µV / °C			
Drift: Offset Temperature Coefficient	2 µV / °C			
Thermocouple Accuracy [°C]	B,R,S	C,D,G	E,J,K	N,T
From factory	±5.0	±4.0	± 2.0	±3.0
After user gain and offset commands	±3.0	±2.0	± 0.8	±2.0
Isolation: Transformer	1500 V			
Isolation: Channel to Channel	250 V continuous (1500 V transient)			
Power Requirements	5 VDC (±0.15) @ 150 mA			
Input Resistance	100 megohms (each channel)			
Ambient Temperature: Operating Storage	-20 °C to 70 °C -40 °C to 85 °C			
Torque, connector screws	3 in-lb (0.34 N-m)			
Wire size range	22 to 14 AWG			
Agency Approvals	CE, RoHS, DFARS			
Warranty	Lifetime			

Part Number	Description
SNAP-AITM-4i	Isolated four-channel analog type B, C, D, E, G, J, K, N, R, S, or T thermocouple or ±150 mV, ±75 mV, ±50 mV, or ±25 mV input

Description

The SNAP-AITM-4i module provides an input range of ±150 mV, ±75 mV, ±50 mV, ±25 mV, or Type B, C, D, E, G, J, K, N, R, S, or T thermocouple.

The four channels on the module are isolated from each other. Since these channels do not share any common connections, grounded sensors and field devices may be used with them.

SNAP-AITM-4i requires a SNAP PAC rack, a SNAP PAC brain or R-series controller with firmware 9.1 or newer, and PAC Project 9.1 or newer.

Type	-	+	Range
B	Red	Gray	+42 °C to +1,820 °C
C, D, G	Red	White	0 °C to +2,320 °C
E	Red	Purple	-270 °C to +1,000 °C
J	Red	White	-210 °C to +1,200 °C
K	Red	Yellow	-270 °C to +1,372 °C
N	Red	Orange	-270 °C to +1,300 °C
R, S	Red	Black	-50 °C to +1,768 °C
T	Red	Blue	-270 °C to +400 °C

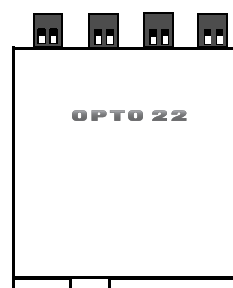
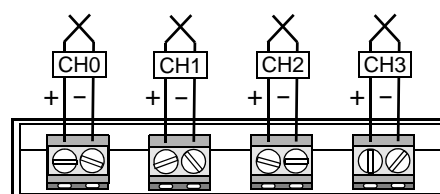

SNAP Isolated Analog Input Modules

Isolated Voltage Input Module -10 VDC to +10 VDC or -5 VDC to +5 VDC

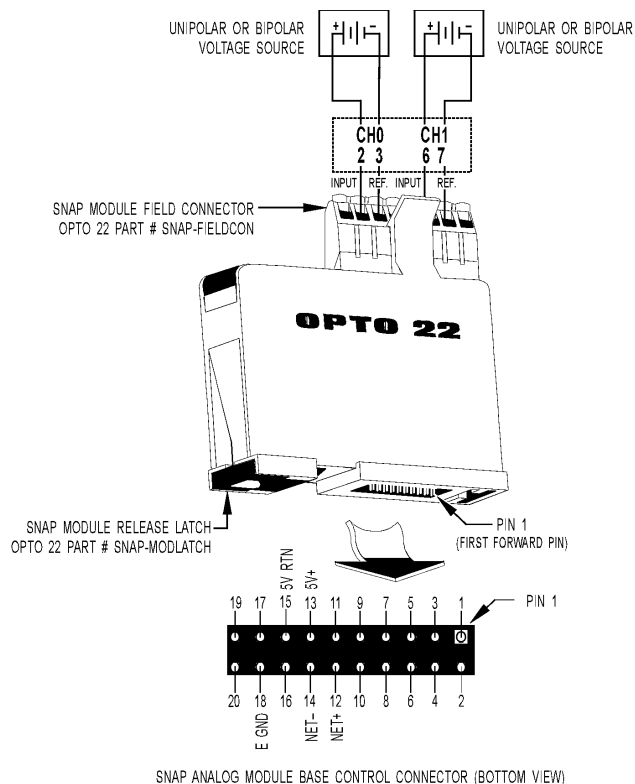

IMPORTANT: The mounting rack connector has 24 pins; the module connector has 20 pins. The extra pins on the mounting rack connector prevent misalignment of the module during installation.

Description

The SNAP-AIV-i module can be configured for either -10 VDC to +10 VDC or -5 VDC to +5 VDC operation on each channel. The SNAP-AIV-i provides two channels that are isolated from each other. Since these channels do not share any common connections, grounded sensors and field devices may be used with them.

Part Number	Description
SNAP-AIV-i	Isolated two-channel analog voltage input -10 VDC to +10 VDC or -5 VDC to +5 VDC

Specifications

Input Range	From -10 volts to +10 volts From -5 volts to +5 volts
Maximum Over Range	$\pm 10\%$ (= ± 27500 counts)
Resolution	0.4 mV when configured -10 volts to +10 volts 0.2 mV when configured -5 volts to +5 volts
Input Filtering	-3 dB @ 64 Hz
Input Response Time (% of span/ DV / Dt)	63.2% / 6.7 V / 10 mS
Data Freshness	11 ms for +/- 10 V 18 ms for +/- 5 V
DC Common Mode Rejection	>-120 dB
AC Common Mode Rejection	>-120 dB @ 60 Hz
Maximum Survivable Input	220 VAC or 300 VDC
Maximum Operating Common Mode Voltage	250 V
Accuracy	0.05%, 5 mV @ 10 VDC 2.5 mV @ 5 VDC
Gain Temperature Coefficient	30 PPM/ °C
Offset Temperature Coefficient	15 PPM/ °C
Isolation: Optical	4000 V
Isolation: Transformer	1500 V
Isolation: Channel to Channel	250 V continuous (1500 V transient)
Power Requirements	5 VDC (± 0.15) @ 200 mA
Input Resistance	1 megohms (each channel)
Ambient Temperature: Operating Storage	-20 °C to 70 °C -40 °C to 85 °C
Torque, hold-down screws	4 in-lb (0.45 N-m)
Torque, connector screws	5.26 in-lb (0.6 N-m)
Wire size range	22 to 14 AWG
Agency Approvals	CE, FM, RoHS, DFARS
Warranty	Lifetime

SNAP Isolated Analog Input Modules

Isolated Voltage Input Module -100 VDC to +100 VDC or -50 VDC to +50 VDC

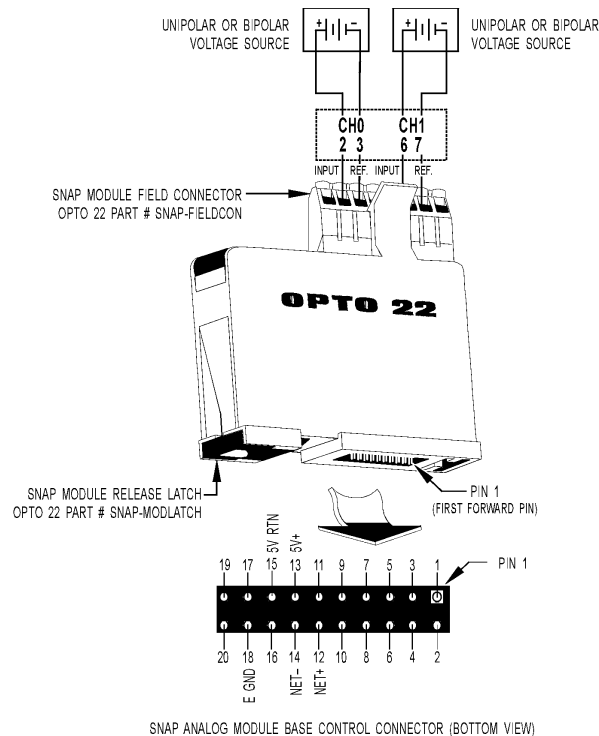

IMPORTANT: The mounting rack connector has 24 pins; the module connector has 20 pins. The extra pins on the mounting rack connector prevent misalignment of the module during installation.

Description

The SNAP-AIV2-i module can be configured for either -100 VDC to +100 VDC or -50 VDC to +50 VDC operation on each channel. The SNAP-AIV2-i provides two channels that are isolated from each other. Since these channels do not share any common connections, grounded sensors and field devices may be used with them.

Part Number	Description
SNAP-AIV2-i	Isolated two-channel analog voltage input -100 VDC to +100 VDC or -50 VDC to +50 VDC

Specifications

Input Range	From -100 volts to +100 volts From -50 volts to +50 volts
Maximum Over Range	± 10% (= ± 27500 counts)
Resolution	4.0 mV when configured -100 volts to +100 volts 2.0 mV when configured -50 volts to +50 volts
Input Filtering	-3 dB @ 64 Hz
Input Response Time (% of span/ DV / Dt)	63.2% / 6.7 V / 10 mS
Data Freshness	11 ms for +/- 100 V 18 ms for +/- 50 V
DC Common Mode Rejection	>-120 dB
AC Common Mode Rejection	>-120 dB @ 60 Hz
Maximum Survivable Input	220 VAC or 300 VDC
Maximum Operating Common Mode Voltage	250 V
Accuracy	0.05%, 50 mV @ 100 VDC 25 mV @ 50 VDC
Gain Temperature Coefficient	30 PPM/ °C
Offset Temperature Coefficient	15 PPM/ °C
Isolation: Optical	4000 V
Isolation: Transformer	1500 V
Isolation: Channel to Channel	250 V continuous (1500 V transient)
Power Requirements	5 VDC (±0.15) @ 200 mA
Input Resistance	1 megohms (each channel)
Ambient Temperature: Operating Storage	-20 °C to 70 °C -40 °C to 85 °C
Torque, hold-down screws	4 in-lb (0.45 N-m)
Torque, connector screws	5.26 in-lb (0.6 N-m)
Wire size range	22 to 14 AWG
Agency Approvals	CE, RoHS, DFARS
Warranty	Lifetime

SNAP Isolated Analog Input Modules

Dimensional Drawing

All Modules Except SNAP-AITM-i, SNAP-AITM2-i, SNAP-AITM-4i, SNAP-AIMA-iSRC, and SNAP-AIMA-iSRC-FM

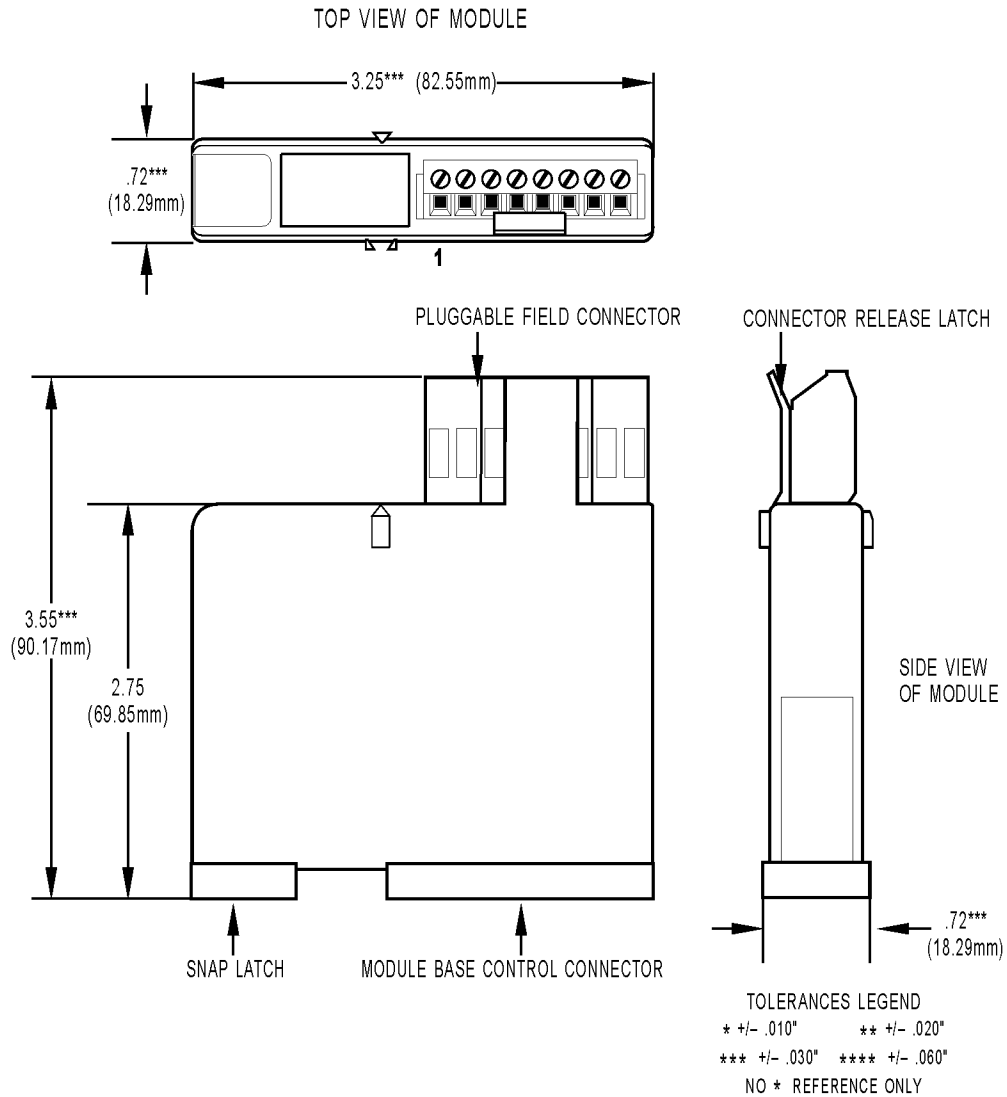

SNAP Isolated Analog Input Modules

Dimensional Drawing

SNAP-AITM-i and SNAP-AITM2-i Modules

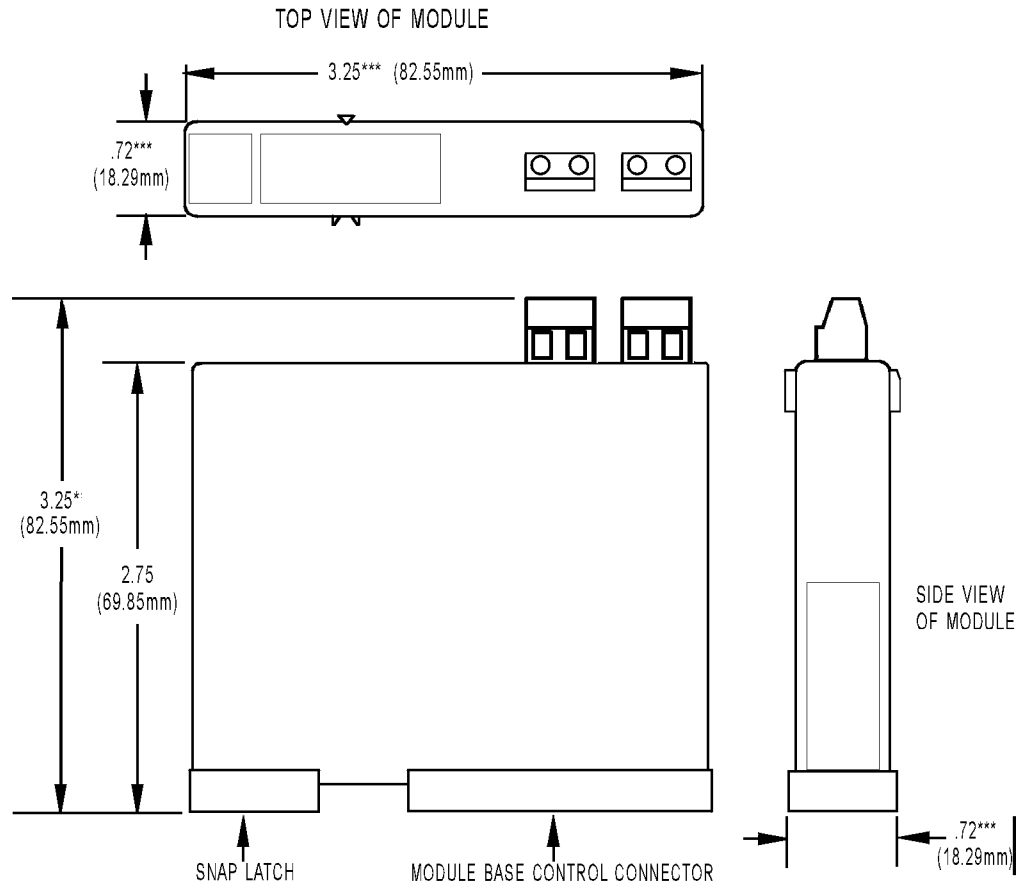

TOLERANCES LEGEND
 * +/- .010" ** +/- .020"
 *** +/- .030" **** +/- .060"
 NO * REFERENCE ONLY

SNAP Isolated Analog Input Modules

Dimensional Drawing

SNAP-AITM-4i Module

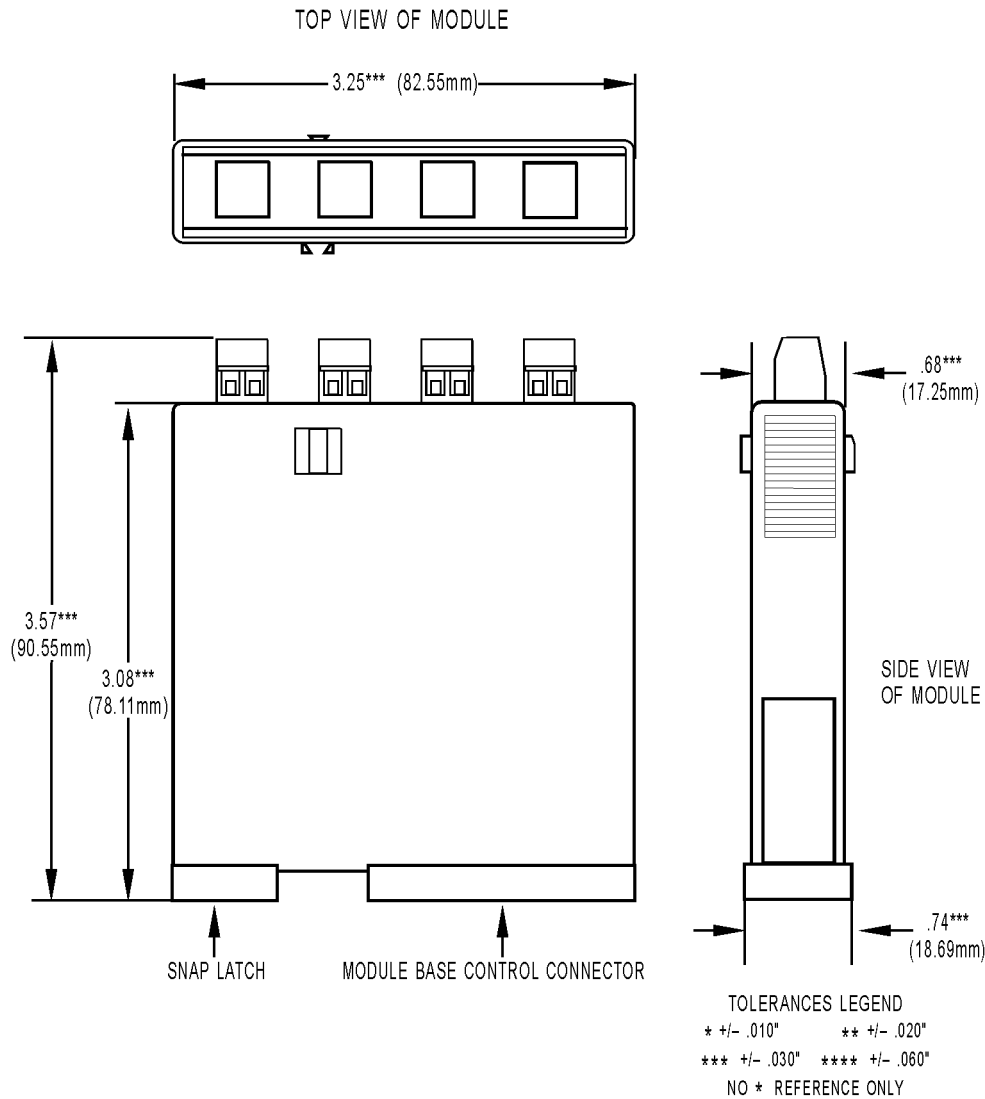

SNAP Isolated Analog Input Modules

Dimensional Drawing

SNAP-AIMA-iSRC and SNAP-AIMA-iSRC-FM Modules

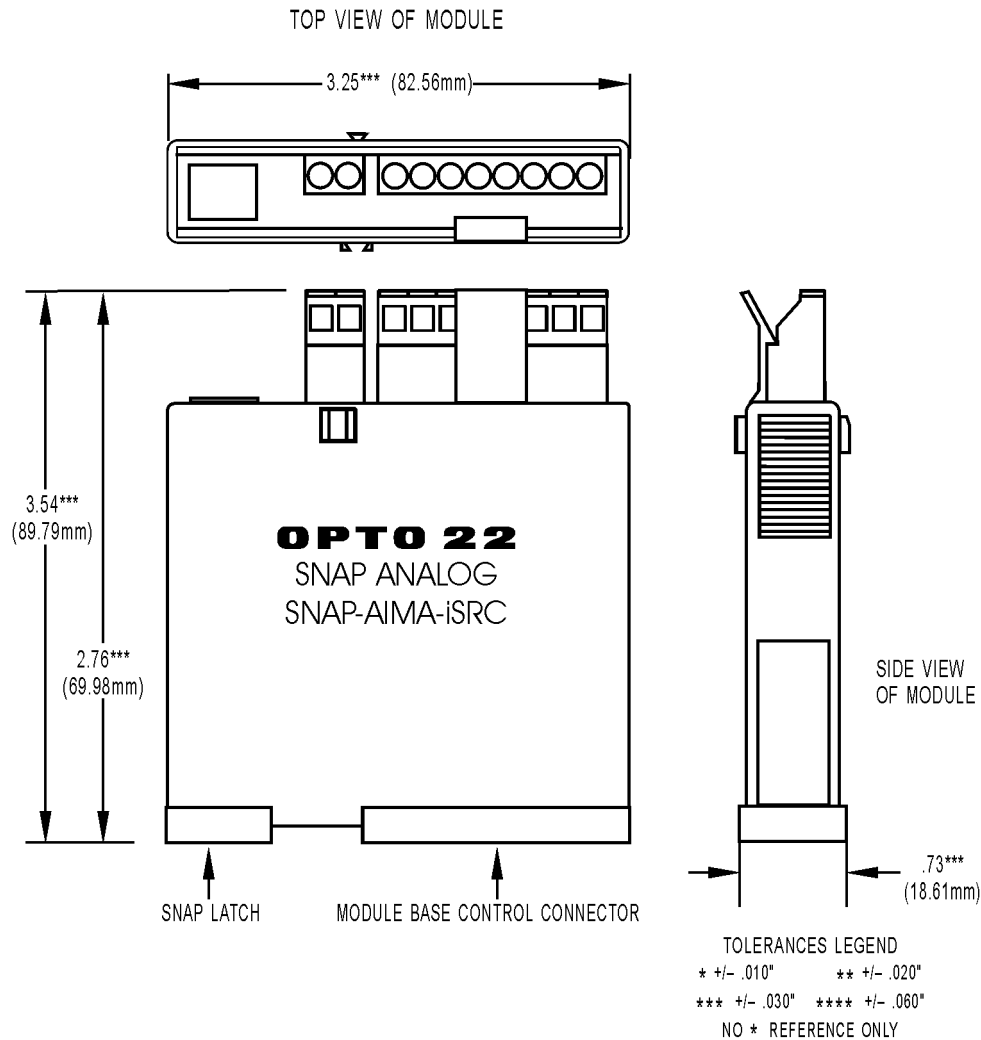

SNAP Isolated Analog Input Modules

Dimensional Drawing

All Modules

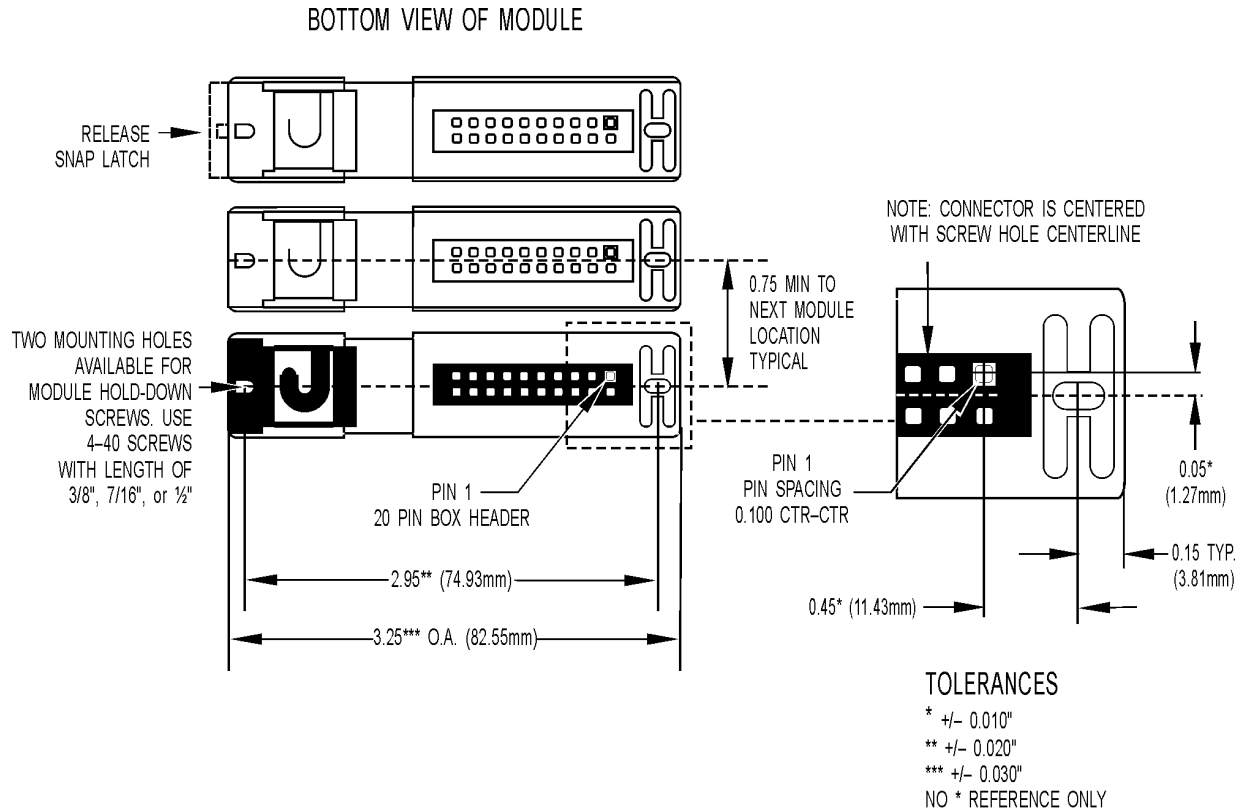

IMPORTANT: The mounting rack connector has 24 pins; the module connector has 20 pins. The extra pins on the mounting rack connector prevent misalignment of the module during installation.

SNAP Isolated Analog Input Modules

Dimensional Drawing

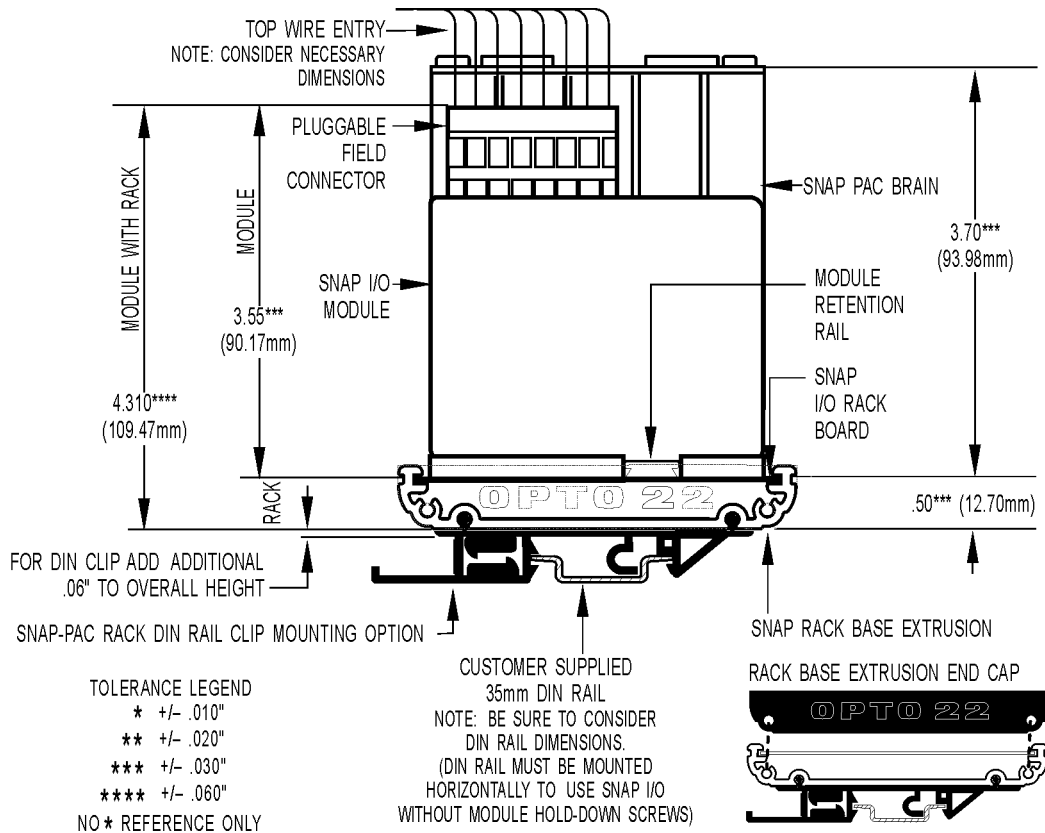

SNAP Isolated Analog Input Modules

Dimensional Drawing

Height on Rack: SNAP-AITMi and SNAP-AITM2-i Modules

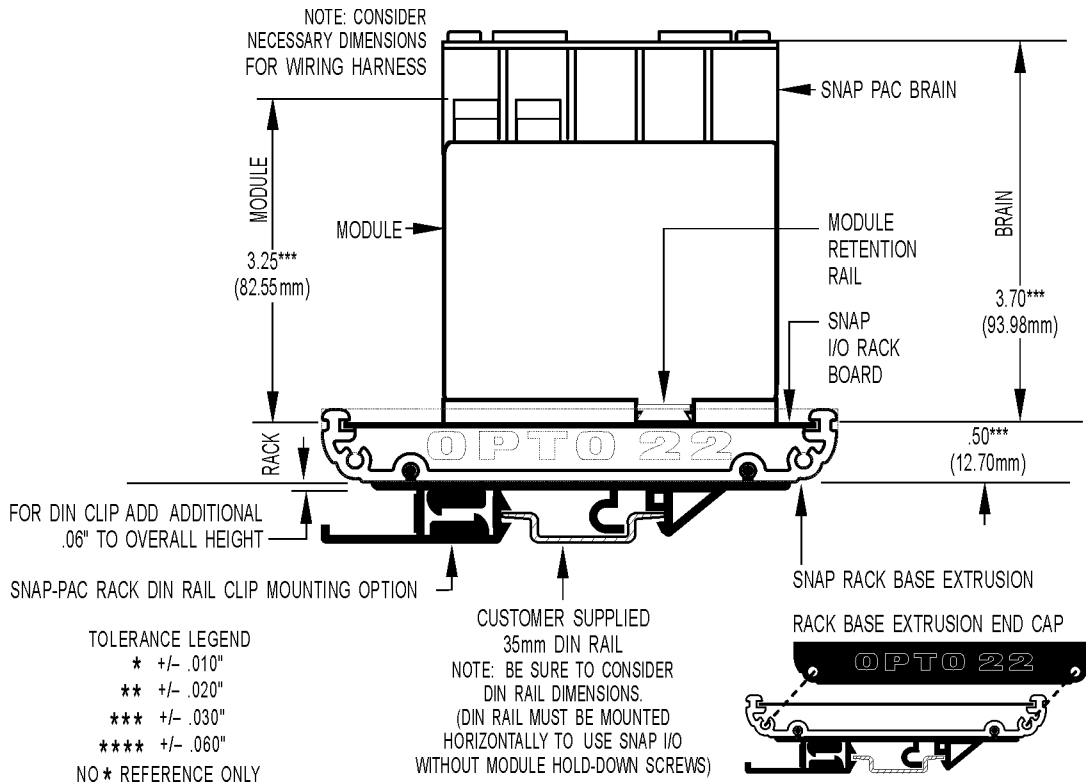

More About Opto 22

Products

Opto 22 develops and manufactures reliable, flexible, easy-to-use hardware and software products for industrial automation, energy management, remote monitoring, and data acquisition applications.

groov

groov puts your system on your mobile device. With zero programming, you can build mobile operator interfaces to monitor and control systems from Allen-Bradley, Siemens, Schneider Electric, Modicon, and many more. Web-based groov puts mobile-ready gadgets at your fingertips. Tag them from your existing tag database, and they automatically scale for use on any device with a modern web browser. See groov.com for more information and your free trial.

SNAP PAC System

Designed to simplify the typically complex process of selecting and applying an automation system, the SNAP PAC System consists of four integrated components:

- SNAP PAC controllers
- PAC Project™ Software Suite
- SNAP PAC brains
- SNAP I/O™

SNAP PAC Controllers

Programmable automation controllers (PACs) are multifunctional, modular controllers based on open standards.

Opto 22 has been manufacturing PACs for over two decades. The standalone SNAP PAC S-series, the rack-mounted SNAP PAC R-series, and the software-based SoftPAC™ all handle a wide range of digital, analog, and serial functions for data collection, remote monitoring, process control, and discrete and hybrid manufacturing.

SNAP PACs are based on open Ethernet and Internet Protocol (IP) standards, so you can build or extend a system easily, without the expense and limitations of proprietary networks and protocols. Wired+Wireless™ models are also available.

PAC Project Software Suite

Opto 22's PAC Project Software Suite provides full-featured, cost-effective control programming, HMI (human machine interface) development and runtime, OPC server, and database connectivity software for your SNAP PAC System.

Control programming includes both easy-to-learn flowcharts and optional scripting. Commands are in plain English; variables and I/O point names are fully descriptive.

PAC Project Basic offers control and HMI tools and is free for download on our website, www.opto22.com. PAC Project

Professional, available for separate purchase, adds one SoftPAC, OptoOPCServer, OptoDataLink, options for controller redundancy or segmented networking, and support for legacy Opto 22 serial *mistic*™ I/O units.

SNAP PAC Brains

While SNAP PAC controllers provide central control and data distribution, SNAP PAC brains provide distributed intelligence for I/O processing and communications. Brains offer analog, digital, and serial functions, including thermocouple linearization; PID loop control; and optional high-speed digital counting (up to 20 kHz), quadrature counting, TPO, and pulse generation and measurement.

SNAP I/O

I/O provides the local connection to sensors and equipment. Opto 22 SNAP I/O offers 1 to 32 points of reliable I/O per module, depending on the type of module and your needs. Analog, digital, and serial modules are all mixed on the same mounting rack and controlled by the same processor (SNAP PAC brain or rack-mounted controller).

Quality

Founded in 1974, Opto 22 has established a worldwide reputation for high-quality products. All are made in the U.S.A. at our manufacturing facility in Temecula, California. Because we test each product twice before it leaves our factory, rather than only testing a sample of each batch, we can guarantee most solid-state relays and optically isolated I/O modules for life.

Free Product Support

Opto 22's California-based Product Support Group offers free, comprehensive technical support for Opto 22 products. Our staff of support engineers represents decades of training and experience. Support is available in English and Spanish by phone or email, Monday–Friday, 7 a.m. to 5 p.m. PST.

Additional support is always available on our website: how-to videos, OptoKnowledgeBase, self-training guide, troubleshooting and user's guides, and OptoForums.

In addition, hands-on training is available for free at our Temecula, California headquarters, and you can [register online](#).

Purchasing Opto 22 Products

Opto 22 products are sold directly and through a worldwide network of distributors, partners, and system integrators. For more information, contact Opto 22 headquarters at 800-321-6786 or 951-695-3000, or visit our website at www.opto22.com.



www.opto22.com