

X2Y[®] FILTER & DECOUPLING CAPACITORS

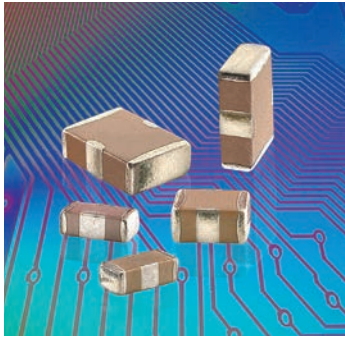

X2Y[®] filter capacitors employ a unique, patented low inductance design featuring two balanced capacitors that are immune to temperature, voltage and aging performance differences. These components offer superior decoupling and EMI filtering performance, virtually eliminate parasitics, and can replace multiple capacitors and inductors saving board space and reducing assembly costs.

ADVANTAGES

- One device for EMI suppression or decoupling
- Replace up to 7 components with one X2Y
- Differential and common mode attenuation
- Matched capacitance line to ground, both lines
- Low inductance due to cancellation effect

APPLICATIONS

- Amplifier Filter & Decoupling
- High Speed Data Filtering
- EMC I/O Filtering
- FPGA / ASIC / μ -P Decoupling
- DDR Memory Decoupling

| EMI Filtering (1 Y-Cap.) | | <10pF | 10pF | 22pF | 27pF | 33pF | 47pF | 100pF | 220pF | 470pF | 1000pF | 1500pF | 2200pF | 4700pF | .010 μ F | .015 μ F | .022 μ F | .039 μ F | .047 μ F | 0.10 μ F | 0.18 μ F | 0.22 μ F | 0.33 μ F | 0.40 μ F | 0.47 μ F | 1.0 μ F | |
|--------------------------|-----------|-------|------|------|------|------|------|-------|-------|-------|--------|--------|--------|--------|--------------|--------------|--------------|--------------|--------------|--------------|--------------|--------------|--------------|--------------|--------------|-------------|--|
| Power Bypass (2 Y-Caps.) | | <20pF | 20pF | 44pF | 54pF | 66pF | 94pF | 200pF | 440pF | 940pF | 2000pF | 3000pF | 4400pF | 9400pF | .020 μ F | .030 μ F | .044 μ F | .078 μ F | .094 μ F | 0.20 μ F | 0.36 μ F | 0.44 μ F | 0.66 μ F | 0.80 μ F | 0.94 μ F | 2.0 μ F | |
| SIZE | CAP. CODE | XR | 100 | 220 | 270 | 330 | 470 | 101 | 221 | 471 | 102 | 152 | 222 | 472 | 103 | 153 | 223 | 393 | 473 | 104 | 184 | 224 | 334 | 404 | 474 | 105 | |
| 0402 (X07) | NP0 | 50 | 50 | 50 | 50 | 50 | 50 | 50 | | | | | | | | | | | | | | | | | | | |
| | X7R | | | | | | | | 50 | 50 | 50 | 50 | 50 | 50 | 16 | | | | | | | | | | | | |
| 0603 (X14) | NP0 | 100 | 100 | 100 | 100 | 100 | 50 | 50 | 50 | | | | | | | | | | | | | | | | | | |
| | X7R | | | | | | 100 | 100 | 100 | 100 | 100 | 100 | 100 | 100 | 50 | 25 | 25 | | 16 | 10 | | 10 | | | | | |
| 0805 (X15) | NP0 | | 100 | 100 | 100 | 100 | 100 | 100 | 100 | 50 | | | | | | | | | | | | | | | | | |
| | X7R | | | | | | | 100 | 100 | 100 | 100 | 100 | 100 | 100 | 100 | 50 | 50 | | 50 | 25 | | | | | | | |
| 1206 (X18) | NP0 | | | | | | | | | | 100 | | | | | | | | | | | | | | | | |
| | X7R | | | | | | | | | | | | | | 100 | 100 | 100 | | 100 | 100 | | 16 | 16 | | 10 | | |
| 1210 (X41) | X7R | | | | | | | | | | | | | | 500 | | | | 100 | | 100 | 100 | | 25 | 16 | | |
| 1410 (X44) | X7R | | | | | | | | | | | | | | | 500 | | | | | | | | 100 | | | |
| 1812 (X43) | X7R | | | | | | | | | | | | | | | | | 500 | | | | | | | 100 | | |

Contact factory for part combinations not shown.
 Filtering capacitance is specified as Line-to-Ground (Terminal A or B to G)
 Power Bypass capacitance is specified Power-to-Ground (A + B to G)
 Rated voltage is from line to ground in Circuit 1, power to ground in Circuit 2 .

HOW TO ORDER X2Y[®] CAPACITORS

P/N written: 101X14W102MV4T

| 100 | X14 | W | 102 | M | V | 4 | T | +AQ |
|---|--|--------------------|---|--|---|------------------------------|--|-------------------------------------|
| VOLTAGE | SIZE | DIELECTRIC | CAPACITANCE | TOLERANCE | TERMINATION | MARKING | PACKING | QUALIFICATION |
| 6R3 = 6.3 V 100 = 10 V 160 = 16 V 250 = 25 V 500 = 50 V 101 = 100 V 501 = 500 V | X07 = 0402 X14 = 0603 X15 = 0805 X18 = 1206 X41 = 1210 X44 = 1410 X43 = 1812 | N = NP0 W = X7R | 1st two digits are significant; third digit denotes number of zeros, R = decimal. 102 = 1000 pF 104 = 0.10 μ F 5R6 = 5.6pF | M = \pm 20% * D = \pm 0.50 pF *Values < 10 pF only | V = Ni Barrier with 100% Tin Plating (Matte) F = Polyterm flexible termination T = SnPb | 4 = Unmarked (Not available) | E = Embossed 7" T = Punched 7" No code = bulk Tape specs. per EIA RS481 | AEC-Q200 Qualification * (optional) |

X2Y[®] technology patents and registered trademark under license from X2Y ATTENUATORS, LLC



X2Y® FILTER & DECOUPLING CAPACITORS

EMI Filtering Scc21

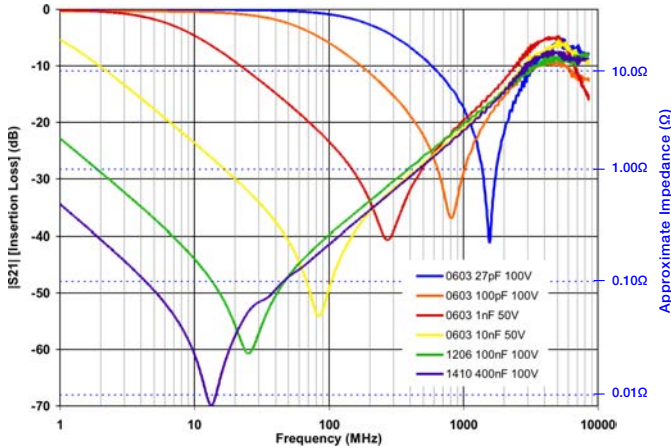
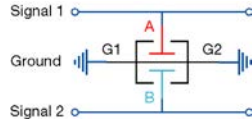

Power Bypass S21

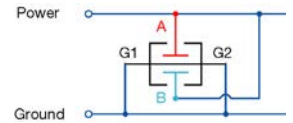

Labeled capacitance values below follow the P/N order code (single Y cap value) Effective capacitance measured in Circuit 2 is 2X of the labeled single Y cap value.

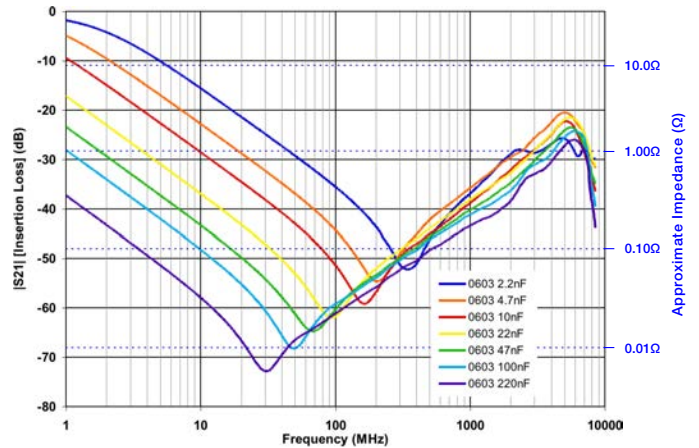

More data at <https://s21plotter.johansondielectrics.com/>

ELECTRICAL CHARACTERISTICS

| | NP0 | X7R |
|---|---|---|
| TEMPERATURE COEFFICIENT: | 0±30ppm/°C (-55 to +125°C) | ±15% (-55 to +125°C) |
| DIELECTRIC STRENGTH: | Vrated ≤100VDC: DWV = 2.5 X WVDC, 25°C, 50mA max. Vrated = 500VDC: DWV = 1.5 X WVDC, 25°C, 50mA max. | |
| DISSIPATION FACTOR: | 0.1% max. | WVDC ≥ 50 VDC: 2.5% max. WVDC = 25 VDC: 3.5% max. WVDC = 10-16 VDC: 5.0% max. WVDC = 6.3 VDC: 10% max. |
| INSULATION RESISTANCE (MIN. @ 25°C, WVDC) | C ≤ 0.047μF: 1000 ΩF or 100 GΩ, whichever is less C > 0.047μF: 500 ΩF or 10 GΩ, whichever is less | |
| TEST CONDITIONS: | C > 100 pF; 1kHz ±50Hz; 1.0±0.2 VRMS C ≤ 100 pF; 1Mhz ±50kHz; 1.0±0.2 VRMS | 1.0kHz±50Hz @ 1.0±0.2 Vrms |
| OTHER: | See page 79 for additional dielectric specifications. | |

Cross-sectional View

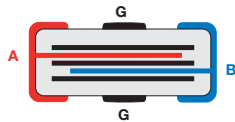

Dimensional View

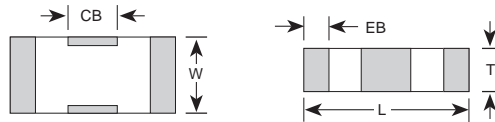

CASE SIZE

| | 0402 (X07) | | 0603 (X14) | | 0805 (X15) | | 1206 (X18) | | 1210 (X41) | | 1410 (X44) | | 1812 (X43) | |
|----|---------------|---------------|---------------|---------------|---------------|---------------|---------------|---------------|---------------|---------------|---------------|---------------|---------------|---------------|
| | IN | MM | IN | MM | IN | MM | IN | MM | IN | MM | IN | MM | IN | MM |
| L | 0.045 ± 0.003 | 1.143 ± 0.076 | 0.064 ± 0.005 | 1.626 ± 0.127 | 0.080 ± 0.008 | 2.032 ± 0.203 | 0.124 ± 0.010 | 3.150 ± 0.254 | 0.125 ± 0.010 | 3.175 ± 0.254 | 0.140 ± 0.010 | 3.556 ± 0.254 | 0.174 ± 0.010 | 4.420 ± 0.254 |
| W | 0.025 ± 0.003 | 0.635 ± 0.076 | 0.035 ± 0.005 | 0.889 ± 0.127 | 0.050 ± 0.008 | 1.270 ± 0.203 | 0.063 ± 0.010 | 1.600 ± 0.254 | 0.098 ± 0.010 | 2.489 ± 0.254 | 0.098 ± 0.010 | 2.490 ± 0.254 | 0.125 ± 0.010 | 3.175 ± 0.254 |
| T | 0.020 max | 0.508 max | 0.026 max | 0.660 max | 0.040 max | 1.016 max | 0.050 max | 1.270 max | 0.070 max | 1.778 max | 0.070 max | 1.778 max | 0.090 max | 2.286 max |
| EB | 0.008 ± 0.003 | 0.203 ± 0.076 | 0.010 ± 0.006 | 0.254 ± 0.152 | 0.012 ± 0.008 | 0.305 ± 0.203 | 0.016 ± 0.010 | 0.406 ± 0.254 | 0.018 ± 0.010 | 0.457 ± 0.254 | 0.018 ± 0.010 | 0.457 ± 0.254 | 0.022 ± 0.012 | 0.559 ± 0.305 |
| CB | 0.012 ± 0.003 | 0.305 ± 0.076 | 0.018 ± 0.004 | 0.457 ± 0.102 | 0.022 ± 0.005 | 0.559 ± 0.127 | 0.040 ± 0.005 | 1.016 ± 0.127 | 0.045 ± 0.005 | 1.143 ± 0.127 | 0.045 ± 0.005 | 1.143 ± 0.127 | 0.045 ± 0.005 | 1.143 ± 0.127 |



X2Y® FILTER & DECOUPLING CAPACITORS

THE X2Y® DESIGN - A BALANCED, LOW ESL, "CAPACITOR CIRCUIT"

The X2Y® capacitor design starts with standard 2 terminal MLC capacitor's opposing electrode sets, A & B, and adds a third electrode set (G) which surround each A & B electrode. The result is a highly versatile three node capacitive circuit containing two tightly matched, low inductance capacitors in a compact, four-terminal SMT chip.

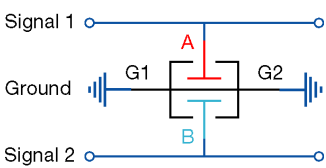
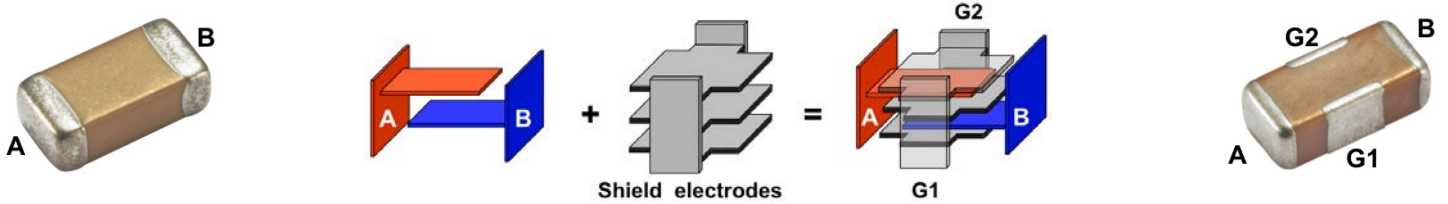

EMI FILTERING:

The X2Y® component contains two shunt or "line-to-ground" Y capacitors. Ultra-low ESL (equivalent series inductance) and tightly matched inductance of these capacitors provides unequalled high frequency Common-Mode noise filtering with low noise mode conversion. X2Y® components reduce EMI emissions far better than unbalanced discrete shunt capacitors or series inductive filters. Differential signal loss is determined by the cut off frequency of the single line-to-ground (Y) capacitor value of an X2Y®.

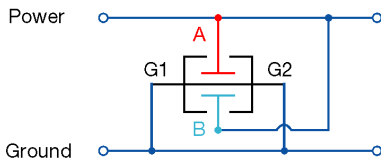

POWER BYPASS / DECOUPLING

For Power Bypass applications, X2Ys® two "Y" capacitors are connected in parallel. This doubles the total capacitance and reduces their mounted inductance by 80% or 1/5th the mounted inductance of similar sized MLC capacitors enabling high-performance bypass networks with far fewer components and vias. Low ESL delivers improved High Frequency performance into the GHz range.

GSM RFI ATTENUATION IN AUDIO & ANALOG

GSM handsets transmit in the 850 and 1850 MHz bands using a TDMA pulse rate of 217Hz. These signals cause the GSM buzz heard in a wide range of audio products from headphones to concert hall PA systems or "silent" signal errors created in medical, industrial process control, and security applications. Testing was conducted where an 840MHz GSM handset signal was delivered to the inputs of three different amplifier test circuit configurations shown below whose outputs were measured on a HF spectrum analyzer.

- 1) No input filter, 2 discrete MLC 100nF power bypass caps.
- 2) 2 discrete MLC 1nF input filter, 2 discrete MLC 100nF power bypass caps.
- 3) A single X2Y 1nF input filter, a single X2Y 100nF power bypass cap.

X2Y configuration provided a nearly flat response above the ambient and up to 10 dB improved rejection than the conventional MLCC configuration.

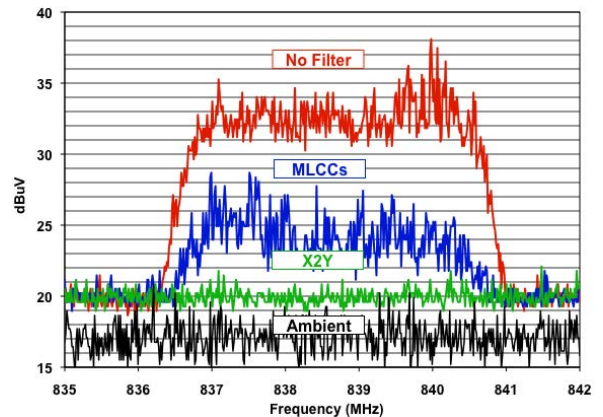

AMPLIFIER INPUT FILTER EXAMPLE

In this example, a single Johanson X2Y® component was used to filter noise at the input of a DC instrumentation amplifier. This reduced component count by 3-to-1 and costs by over 70% vs. conventional filter components that included 1% film Y-capacitors.

| Parameter | X2Y® 10nF | Discrete 10nF, 2 @ 220 pF | Comments |
|-----------------------|---------------|------------------------------|-------------------|
| DC offset shift | < 0.1 μ V | < 0.1 μ V | Referred to input |
| Common mode rejection | 91 dB | 92 dB | |

Source: Analog Devices, "A Designer's Guide to Instrumentation Amplifiers (2nd Edition)" by Charles Kitchin and Lew Counts

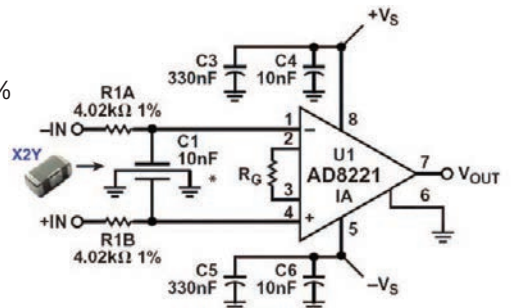

X2Y[®] FILTER & DECOUPLING CAPACITORS

COMMON MODE CHOKE REPLACEMENT

- Superior High Frequency Emissions Reduction
 - Smaller Sizes, Lighter Weight
 - No Current Limitation
 - Vibration Resistant
 - No Saturation Concerns
- See our website for a detailed application note with component test comparisons and circuit emissions measurements.

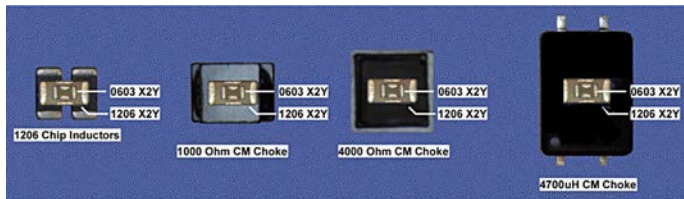

Measured Common Mode Rejection

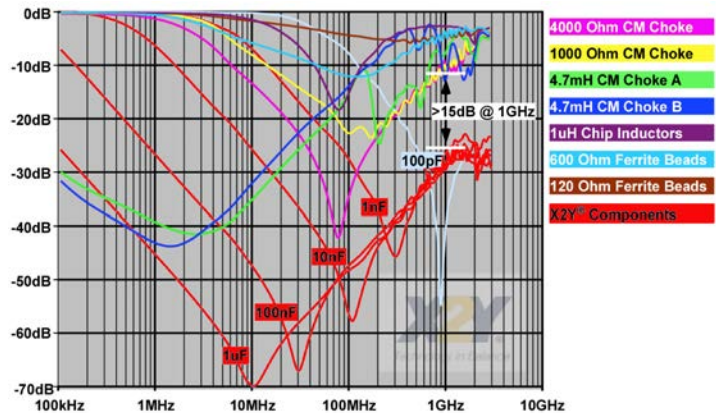

PARALLEL CAPACITOR SOLUTION

A common design practice is to parallel decade capacitance values to extend the high frequency performance of the filter network. This causes an unintended and often over-looked effect of anti-resonant peaks in the filter networks combined impedance. X2Y's very low mounted inductance allows designers to use a single, higher value part and completely avoid the anti-resonance problem. The impedance graph on right shows the combined impedance of a 1nF, 10nF & 100nF 0402 MLC in parallel in RED. The MLC networks anti-resonance peaks are nearly 10 times the desired impedance. A 100nF and 47nF X2Y are plotted in BLUE and GREEN. (The total capacitance of X2Y (Circuit 2) is twice the value, or 200nF and 98nF in this example.) The single X2Y is clearly superior to the three paralleled MLCs.

Decade MLCs vs X2Y Impedance

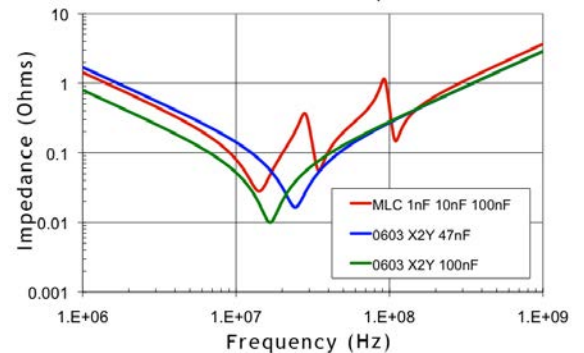

X2Y HIGH PERFORMANCE POWER BYPASS - IMPROVE PERFORMANCE, REDUCE SPACE & VIAS

Actual measured performance of two high performance SerDes FPGA designs demonstrate how a 13 component X2Y bypass network significantly outperforms a 38 component MLC network.

For more information see https://johansondielectrics.com/downloads/JDI_X2Y_STXII.pdf

