

1-965641-1 ✓ ACTIVE

AMP | Timer Connector System

TE Internal #: 1-965641-1

Timer Connector System, Housing for Male Terminals, Wire-to-Wire, 6 Position, 5mm [.197in] Centerline, Blue, Signal

[View on TE.com >](#)



Connectors > Automotive Connectors > Connector Housings > TIMER, CONNECTOR HOUSING



Connector & Housing Type: **Housing for Male Terminals**

Mating Tab Width: **2.8 mm [.11 in]**

Connector System: **Wire-to-Wire**

Number of Positions: **6**

Centerline (Pitch): **5 mm [.197 in]**

[All TIMER, CONNECTOR HOUSING \(538\)](#)

Features

Product Type Features

Connector & Housing Type	Housing for Male Terminals
Connector System	Wire-to-Wire
Sealable	No
Hybrid Connector	No
Primary Locking Feature	On the Terminal

Configuration Features

Number of Positions	6
Number of Rows	2

Electrical Characteristics

Operating Voltage	28 VDC
Nominal Voltage Architecture	12 V, 24 V

Body Features

Cable Exit Angle	180°
Body Material	PA GF
Primary Product Color	Blue

Contact Features

Mating Tab Width	2.8 mm[.11 in]
------------------	----------------



Mechanical Attachment

Mounting Feature	Without
Terminal Position Assurance	No
Strain Relief	No
Mating Alignment Type	Polarized

Housing Features

Centerline (Pitch)	5 mm [.197 in]
--------------------	----------------

Dimensions

Product Width	35.45 mm [1.396 in]
Product Length	17.5 mm [.689 in]
Product Height	30.6 mm [1.205 in]

Usage Conditions

Operating Temperature (Max)	70 °C, 75 °C, 80 °C, 85 °C, 90 °C, 100 °C, 105 °C, 110 °C, 120 °C [158 °F][167 °F][176 °F][185 °F][194 °F][212 °F][221 °F][230 °F][248 °F]
Operating Temperature Range	-40 – 120 °C [-40 – 248 °F]

Operation/Application

Circuit Application	Signal
---------------------	--------

Packaging Features

Packaging Quantity	1500
Packaging Method	Bag

Other

Serviceable	No
Connector Position Assurance Capable	No

Product Compliance

[For compliance documentation, visit the product page on TE.com>](#)

EU RoHS Directive 2011/65/EU	Compliant
EU ELV Directive 2000/53/EC	Compliant
China RoHS 2 Directive MIIT Order No 32, 2016	No Restricted Materials Above Threshold
EU REACH Regulation (EC) No. 1907/2006	Current ECHA Candidate List: JUL 2021 (219)



Candidate List Declared Against: JUL 2021
(219)

Does not contain REACH SVHC

Halogen Content

BFR/CFR/PVC Free, but Br/Cl >900 ppm in other sources.

Solder Process Capability

Not applicable for solder process capability

Product Compliance Disclaimer

This information is provided based on reasonable inquiry of our suppliers and represents our current actual knowledge based on the information they provided. This information is subject to change. The part numbers that TE has identified as EU RoHS compliant have a maximum concentration of 0.1% by weight in homogenous materials for lead, hexavalent chromium, mercury, PBB, PBDE, DBP, BBP, DEHP, DIBP, and 0.01% for cadmium, or qualify for an exemption to these limits as defined in the Annexes of Directive 2011/65/EU (RoHS2). Finished electrical and electronic equipment products will be CE marked as required by Directive 2011/65/EU. Components may not be CE marked. Additionally, the part numbers that TE has identified as EU ELV compliant have a maximum concentration of 0.1% by weight in homogenous materials for lead, hexavalent chromium, and mercury, and 0.01% for cadmium, or qualify for an exemption to these limits as defined in the Annexes of Directive 2000/53/EC (ELV). Regarding the REACH Regulation, the information TE provides on SVHC in articles for this part number is based on the latest European Chemicals Agency (ECHA) 'Guidance on requirements for substances in articles' posted at this URL: <https://echa.europa.eu/guidance-documents/guidance-on-reach>

Compatible Parts



TE Part # CAT-T4827-CH8172
TIMER, CONNECTOR HOUSING



TE Part # 8-968970-1
MCP2.8 GEH 6P



TE Part # CAT-T4827-T273
TIMER, RECEPTACLE AND TAB



TE Part # 968271-1
2. KONT-SICHERUNG 6P



TE Part # 2355073-1
6POS,AMP MCP 2.8,REC HSG,UNSLD,
COD A,GRY



TE Part # 2355073-2
6POS,AMP MCP 2.8,REC HSG,UNSLD,
COD B,NAT



TE Part # 2355073-3
6POS,AMP MCP 2.8,REC HSG,UNSLD,
COD C,BLU

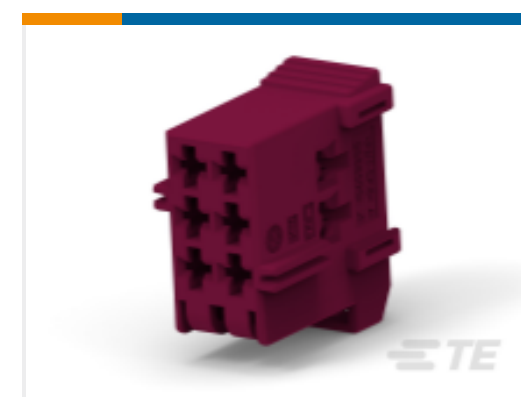

TE Part # 2355073-4
6POS,AMP MCP 2.8,REC HSG,UNSLD,
COD D,VLT



TE Part # 1-962843-3
TAB 2.8x0.8 CONTACT CS SRC Au



TE Part # 2-962842-3
TAB 2.8x0.8 CONTACT CF SRC Au



TE Part # 2-962843-1
TAB 2.8x0.8 CONTACT CF SRC Sn



TE Part # 2-962843-2
TAB 2.8x0.8 CONTACT CF SRC Ag



TE Part # 2-962843-3
TAB 2.8x0.8 CONTACT CF SRC Au



TE Part # 2-962842-2
TAB 2.8x0.8 CONTACT CF SRC Ag

Also in the Series | Timer Connector System

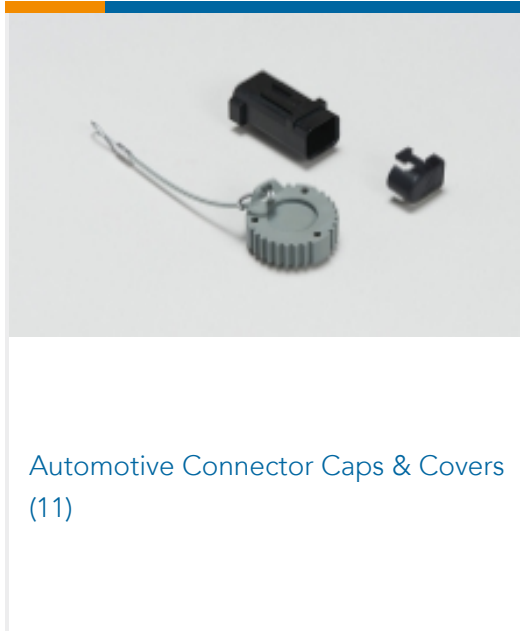

Automotive Connector Caps & Covers (11)

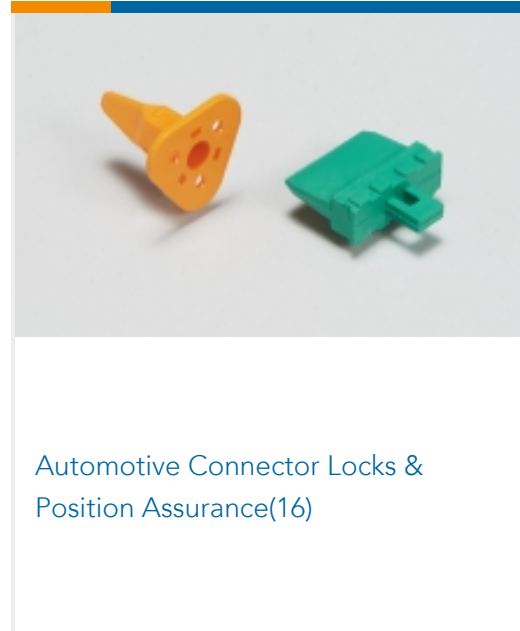

Automotive Connector Locks & Position Assurance(16)

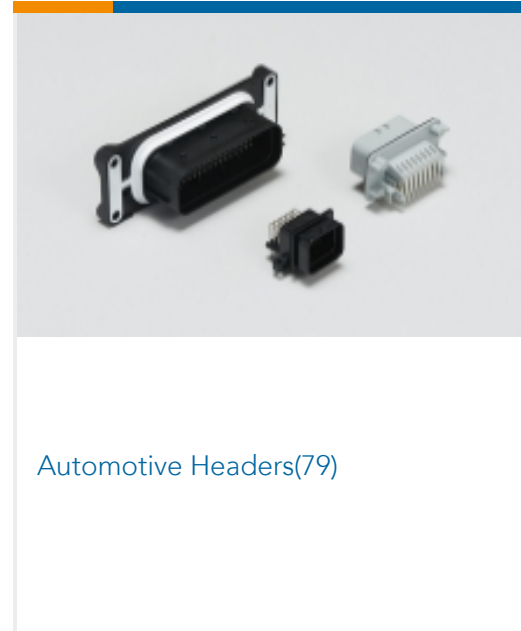

Automotive Headers(79)

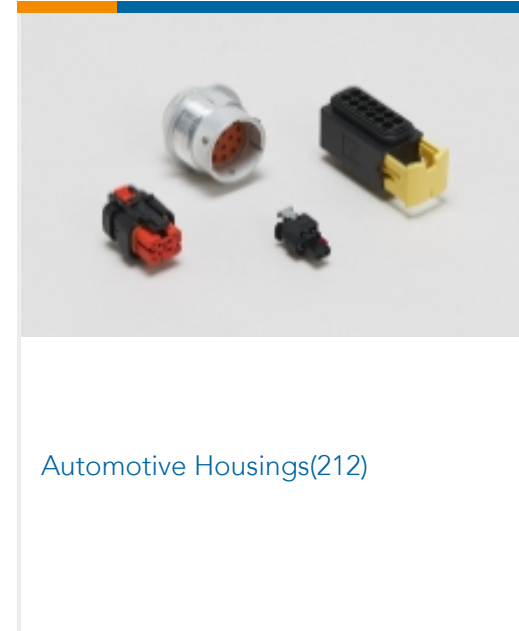

Automotive Housings(212)



Automotive Seals & Cavity Plugs(31)

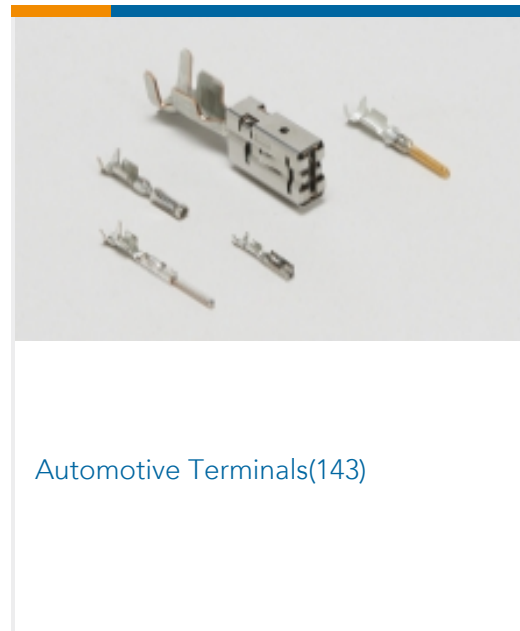

Automotive Terminals(143)

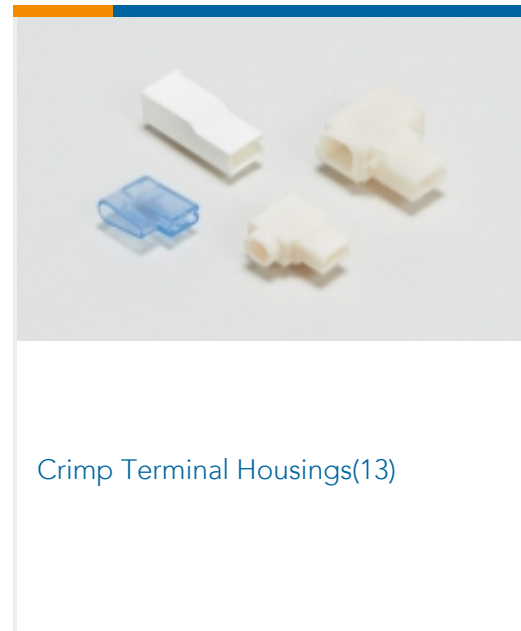

Crimp Terminal Housings(13)

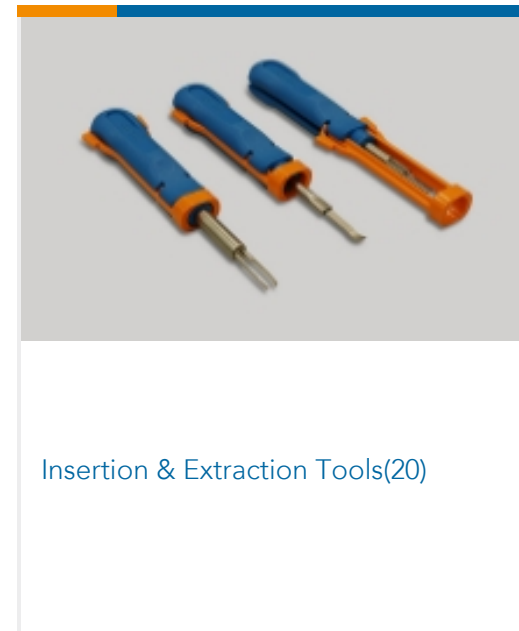

Insertion & Extraction Tools(20)

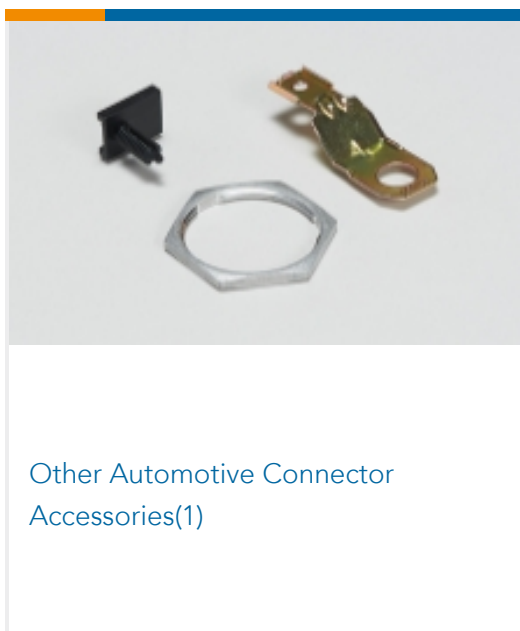

Other Automotive Connector Accessories(1)

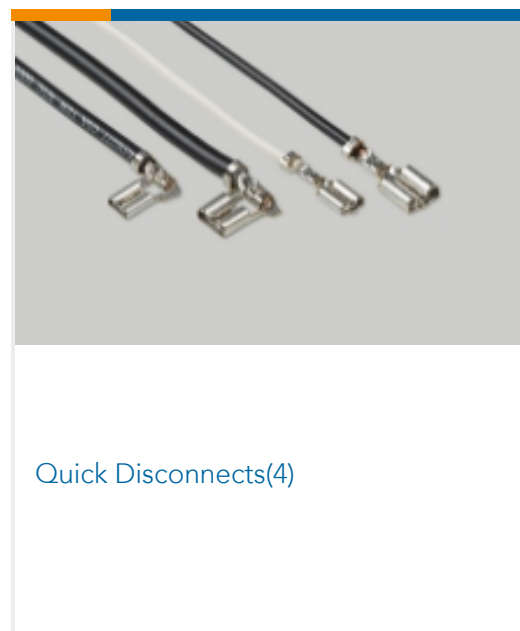

Quick Disconnects(4)

Customers Also Bought



TE Part #1-965640-1
TIMER, CONNECTOR HOUSING



TE Part #1-962842-1
TIMER, RECEPTACLE AND TAB

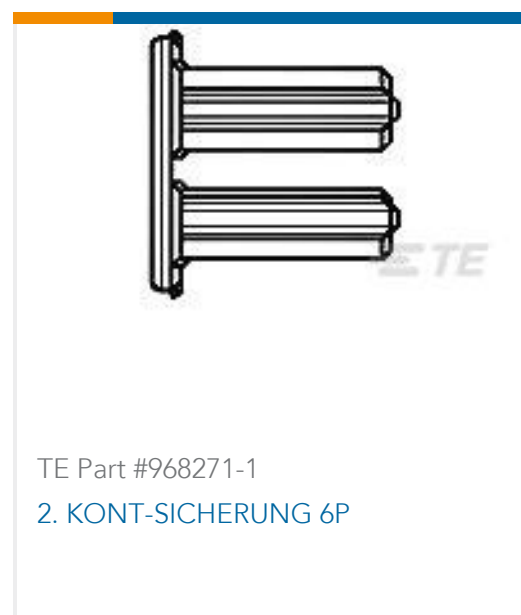

TE Part #968271-1
2. KONT-SICHERUNG 6P



TE Part #1-963745-1
SPECIAL TERMINAL 20-17 AWG PTPB LP



Documents

Product Drawings

[FLACH-STE-GEH2,8 6P](#)

English

[FLACH-STE-GEH2,8 6P](#)

English

CAD Files

[3D PDF](#)

3D

Customer View Model

[ENG_CVM_CVM_1-965641-1_D.2d_dxf.zip](#)

English

Customer View Model

[ENG_CVM_CVM_1-965641-1_D.3d_igs.zip](#)

English

Customer View Model

[ENG_CVM_CVM_1-965641-1_D.3d_stp.zip](#)

English

By downloading the CAD file I accept and agree to the [Terms and Conditions](#) of use.

Datasheets & Catalog Pages

[Timer Interconnection System](#)

English

Product Specifications

[Application Specification](#)

English

Product Environmental Compliance

[TE Material Declaration](#)

English