

## BARBARA-S-PF

~15° spot beam

### TECHNICAL SPECIFICATIONS:

Dimensions	Ø 70.0 mm
Height	41.7 mm
Fastening	socket
Colour	metal
Box size	480 x 280 x 300 mm
Box weight	6.1 kg
Quantity in Box	288 pcs
ROHS compliant	yes ⓘ





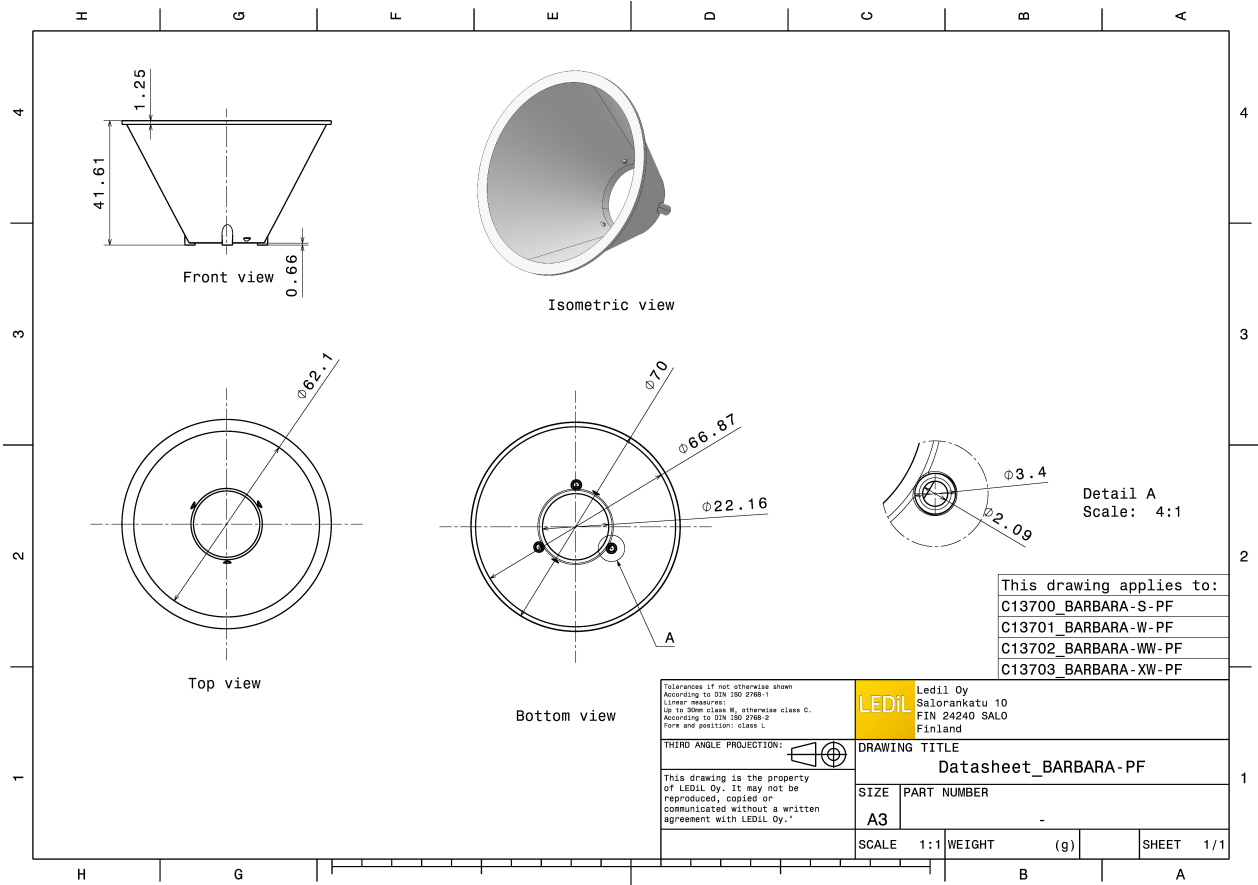

### MATERIAL SPECIFICATIONS:



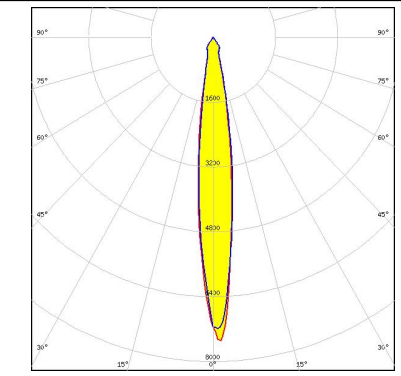

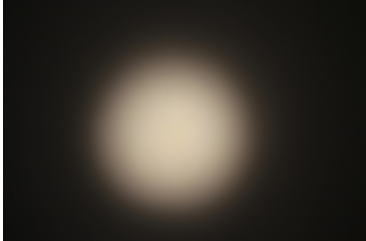
Component	Type	Material	Colour	Coating
BARBARA-S-PF	Reflector	PC	metal	HMDS

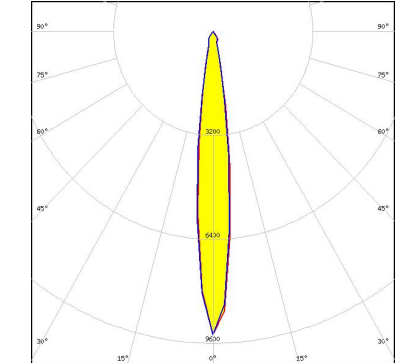

#### PHOTOMETRIC DATA (MEASURED):

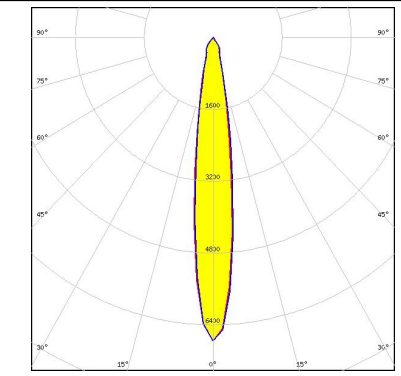
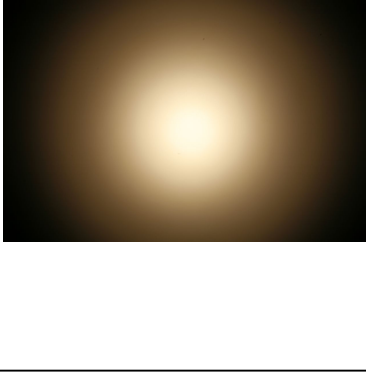
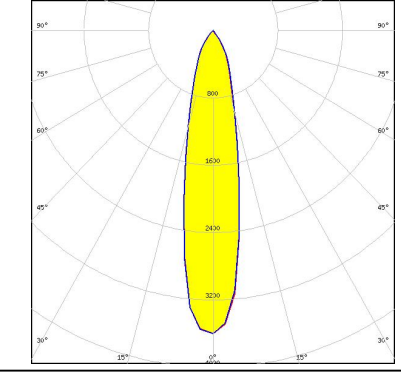
<p>bridgelux.</p> <p>LED V10 Gen7            FWHM 14.0°            Efficiency 88 %            Peak intensity 7.500 cd/lm            LEDs/each optic 1            Light colour White            Required components:            C13709_PF-SOCKET-VERO13-18            Bender Wirth: 434 Typ L1</p>		
<p>bridgelux.</p> <p>LED V15 Gen6            FWHM 18.0°            Efficiency 92 %            Peak intensity 4.750 cd/lm            LEDs/each optic 1            Light colour White            Required components:            C13709_PF-SOCKET-VERO13-18            Bender Wirth: 456 Typ L2</p>		
<p>bridgelux.</p> <p>LED V8 Gen6            FWHM 13.0°            Efficiency 86 %            Peak intensity 10.600 cd/lm            LEDs/each optic 1            Light colour White            Required components:            C13709_PF-SOCKET-VERO13-18            Bender Wirth: 460 Typ L1</p>		
<p>bridgelux.</p> <p>LED VERO10            FWHM 13.0°            Efficiency 90 %            Peak intensity 9.300 cd/lm            LEDs/each optic 1            Light colour White            Required components:            C13708_PF-SOCKET-VERO10</p>		

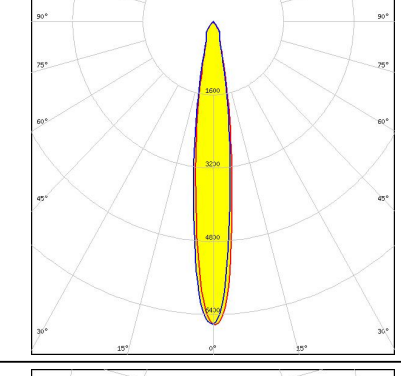
#### PHOTOMETRIC DATA (MEASURED):

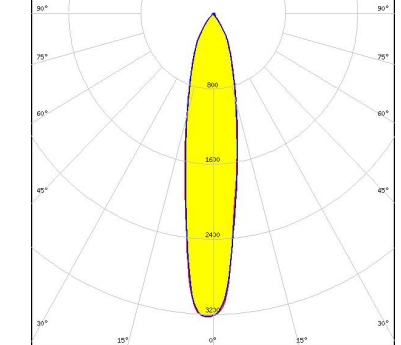
<p>bridgelux.</p> <p>LED VERO13            FWHM 15.0°            Efficiency 91 %            Peak intensity 6.800 cd/lm            LEDs/each optic 1            Light colour White            Required components:            C13709_PF-SOCKET-VERO13-18</p>		
<p>bridgelux.</p> <p>LED VERO18            FWHM 22.0°            Efficiency 91 %            Peak intensity 3.600 cd/lm            LEDs/each optic 1            Light colour White            Required components:            C13709_PF-SOCKET-VERO13-18</p>		
<p>bridgelux.</p> <p>LED Xenio Point 13mm            FWHM 14.0°            Efficiency 91 %            Peak intensity 6.640 cd/lm            LEDs/each optic 1            Light colour White            Required components:            C13709_PF-SOCKET-VERO13-18</p>		
<p>bridgelux.</p> <p>LED Xenio Point 18mm            FWHM 21.0°            Efficiency 86 %            Peak intensity 3.230 cd/lm            LEDs/each optic 1            Light colour White            Required components:            C13709_PF-SOCKET-VERO13-18</p>		

#### PHOTOMETRIC DATA (MEASURED):

#### CITIZEN

LED CLL02x/CLU02x (LES10)  
 FWHM 12.0°  
 Efficiency 89 %  
 Peak intensity 9.200 cd/lm  
 LEDs/each optic 1  
 Light colour White  
 Required components:  
 C13709\_PF-SOCKET-VERO13-18  
 Bender Wirth: 434 Typ L1

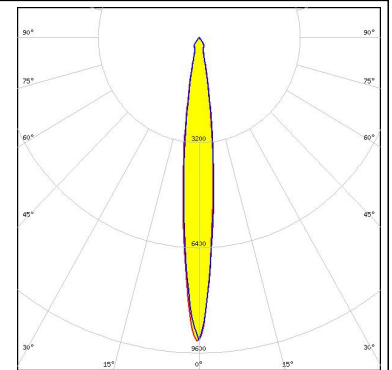

#### CITIZEN

LED CLL03x/CLU03x  
 FWHM 16.0°  
 Efficiency 88 %  
 Peak intensity 5.100 cd/lm  
 LEDs/each optic 1  
 Light colour White  
 Required components:  
 C13709\_PF-SOCKET-VERO13-18  
 Bender Wirth: 433 Typ L1

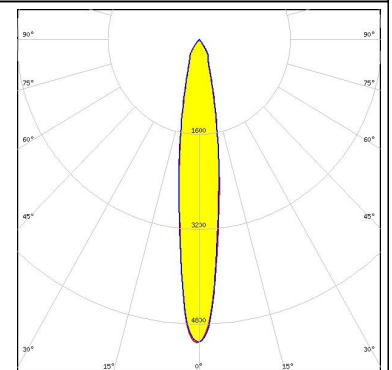
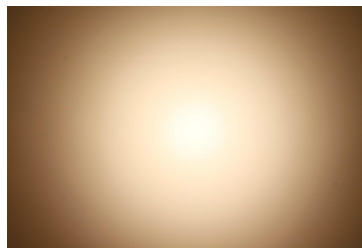

#### CITIZEN

LED CLU720/721  
 FWHM 14.0°  
 Efficiency 87 %  
 Peak intensity 7.300 cd/lm  
 LEDs/each optic 1  
 Light colour White  
 Required components:  
 C13709\_PF-SOCKET-VERO13-18  
 Bender Wirth: 433 Typ L1

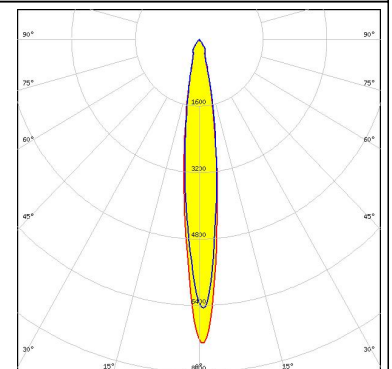
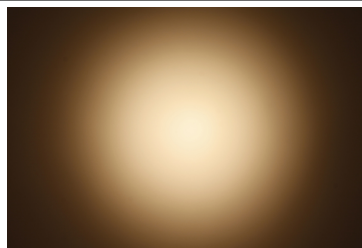

#### CREE

LED CXA/B 15xx  
 FWHM 13.0°  
 Efficiency 85 %  
 Peak intensity 7.400 cd/lm  
 LEDs/each optic 1  
 Light colour White  
 Required components:  
 C13083\_PF-SOCKET  
 C14658\_BARBARA-RZ-LENS

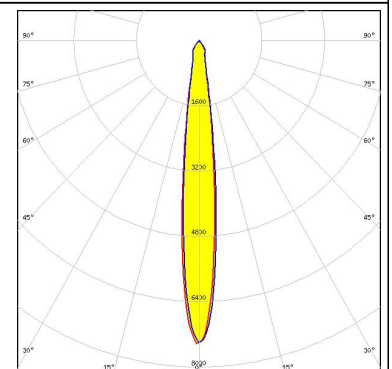
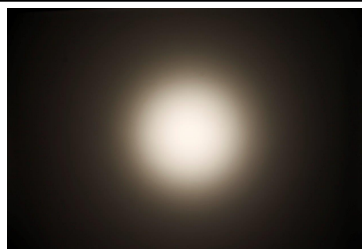

#### PHOTOMETRIC DATA (MEASURED):



LED CXA/B 15xx  
 FWHM 15.0°  
 Efficiency 89 %  
 Peak intensity 6.900 cd/lm  
 LEDs/each optic 1  
 Light colour White  
 Required components:  
 C13709\_PF-SOCKET-VERO13-18  
 Bender Wirth: 441 Typ L1

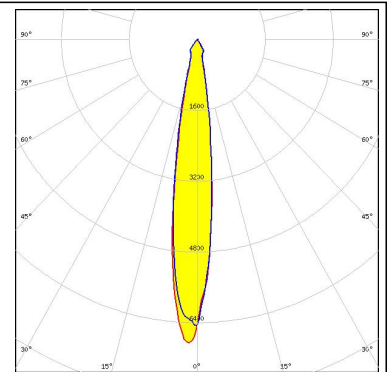

LED CXA/B 15xx  
 FWHM 14.0°  
 Efficiency 91 %  
 Peak intensity 8.600 cd/lm  
 LEDs/each optic 1  
 Light colour White  
 Required components:  
 C14115\_PF-SOCKET-CXA15-18

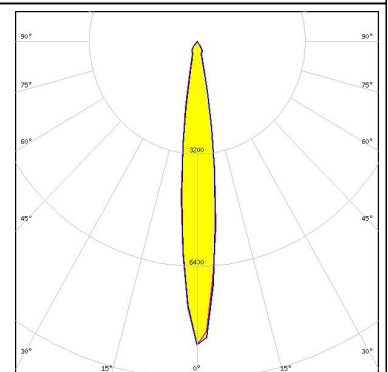
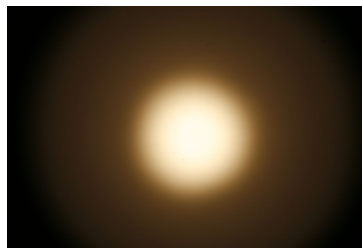

LED CXA/B 1816 & CXA/B 1820 & CXA 1850  
 FWHM 14.0°  
 Efficiency 86 %  
 Peak intensity 6.100 cd/lm  
 LEDs/each optic 1  
 Light colour White  
 Required components:  
 C13709\_PF-SOCKET-VERO13-18  
 Bender Wirth: 437 Typ L1

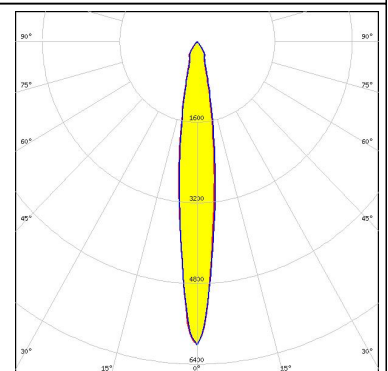
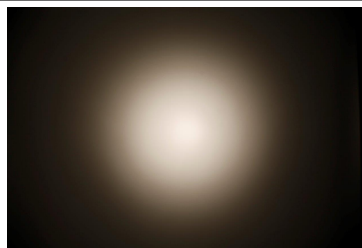

LED CXA/B 1816 & CXA/B 1820 & CXA 1850  
 FWHM 15.0°  
 Efficiency 92 %  
 Peak intensity 6.800 cd/lm  
 LEDs/each optic 1  
 Light colour White  
 Required components:  
 C14115\_PF-SOCKET-CXA15-18

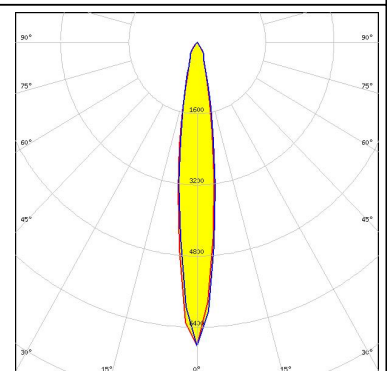

#### PHOTOMETRIC DATA (MEASURED):

#### LUMILEDS

LED LUXEON CoB 1202/1203  
 FWHM 14.0°  
 Efficiency 88 %  
 Peak intensity 7.300 cd/lm  
 LEDs/each optic 1  
 Light colour White  
 Required components:  
 C13709\_PF-SOCKET-VERO13-18  
 Bender Wirth: 438 Typ L1

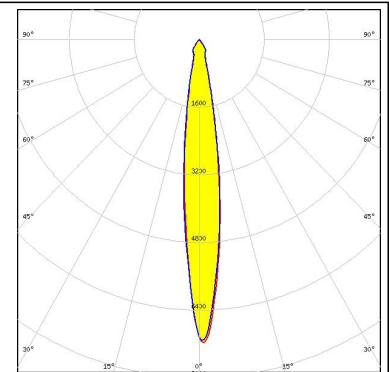
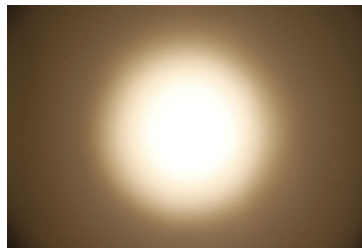

#### LUMILEDS

LED LUXEON CoB 1202/1203  
 FWHM 12.0°  
 Efficiency 90 %  
 Peak intensity 10.600 cd/lm  
 LEDs/each optic 1  
 Light colour White  
 Required components:  
 C14037\_PF-NSX-SOCKET

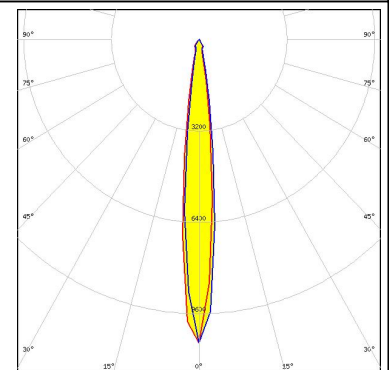

#### LUMILEDS

LED LUXEON CoB 1202s  
 FWHM 9.0°  
 Efficiency 90 %  
 Peak intensity 19.600 cd/lm  
 LEDs/each optic 1  
 Light colour White  
 Required components:  
 C13761\_PF-SOCKET-CXA15

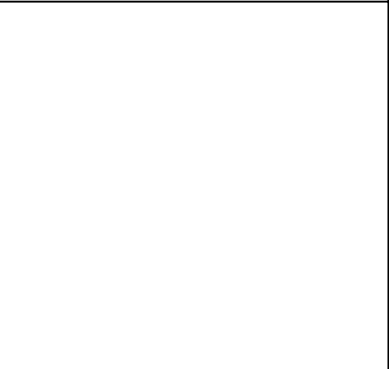
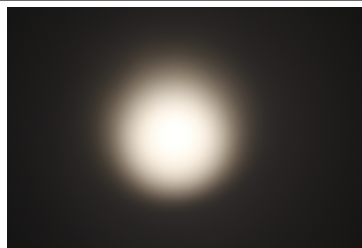

#### NICHIA

LED COB J-Type  
 FWHM 19.0°  
 Efficiency 91 %  
 Peak intensity 4.730 cd/lm  
 LEDs/each optic 1  
 Light colour White  
 Required components:  
 C14037\_PF-NSX-SOCKET

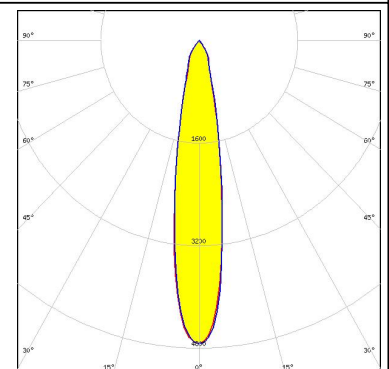

#### PHOTOMETRIC DATA (MEASURED):



LED COB J-Type  
 FWHM 17.0°  
 Efficiency 88 %  
 Peak intensity 4.600 cd/lm  
 LEDs/each optic 1  
 Light colour White  
 Required components:  
 C13709\_PF-SOCKET-VERO13-18  
 Bender Wirth: 463 Typ L2

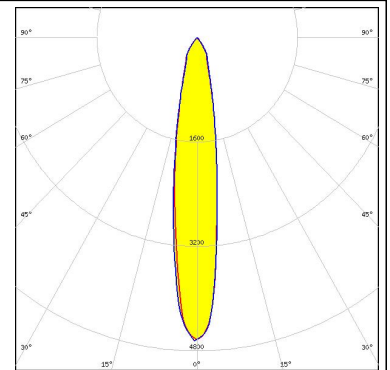
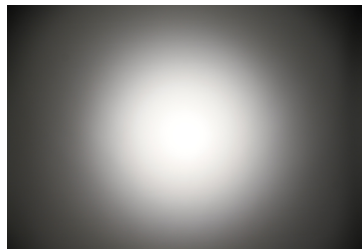

LED COB L-Type (LES 11)  
 FWHM 15.0°  
 Efficiency 90 %  
 Peak intensity 6.800 cd/lm  
 LEDs/each optic 1  
 Light colour White  
 Required components:  
 C14037\_PF-NSX-SOCKET

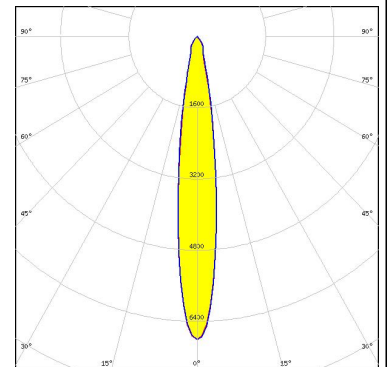

LED COB L-Type (LES 11)  
 FWHM 14.0°  
 Efficiency 86 %  
 Peak intensity 6.100 cd/lm  
 LEDs/each optic 1  
 Light colour White  
 Required components:  
 C13709\_PF-SOCKET-VERO13-18  
 Bender Wirth: 438 Typ L1

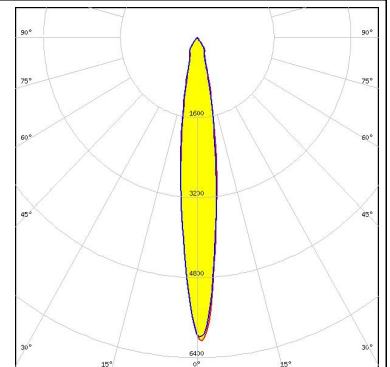
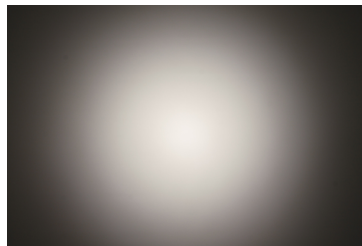

LED COB L-Type (LES 9)  
 FWHM 13.0°  
 Efficiency 90 %  
 Peak intensity 10.100 cd/lm  
 LEDs/each optic 1  
 Light colour White  
 Required components:  
 C14037\_PF-NSX-SOCKET

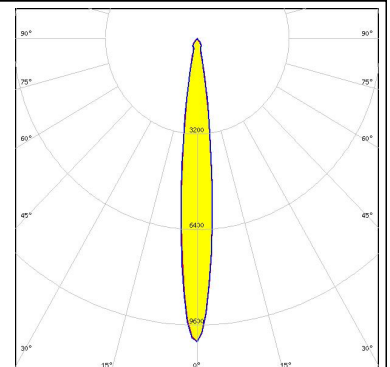



#### PHOTOMETRIC DATA (MEASURED):



LED COB L-Type (LES 9)  
 FWHM 13.0°  
 Efficiency 90 %  
 Peak intensity 8.400 cd/lm  
 LEDs/each optic 1  
 Light colour White  
 Required components:  
 C13709\_PF-SOCKET-VERO13-18  
 Bender Wirth: 438 Typ L1

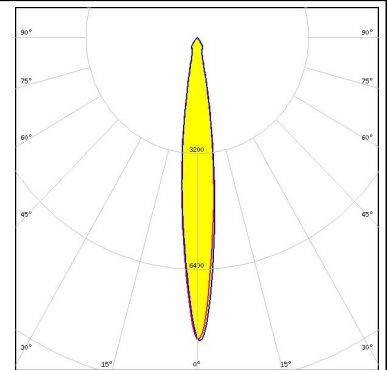

LED NSCxL036A  
 FWHM 11.0°  
 Efficiency 89 %  
 Peak intensity 14.120 cd/lm  
 LEDs/each optic 1  
 Light colour White  
 Required components:  
 C14037\_PF-NSX-SOCKET

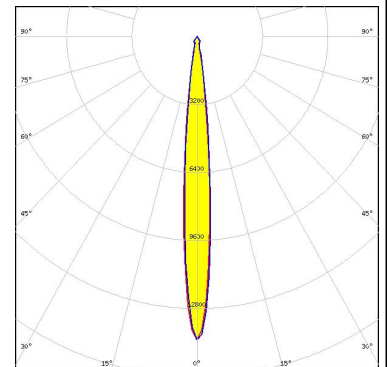
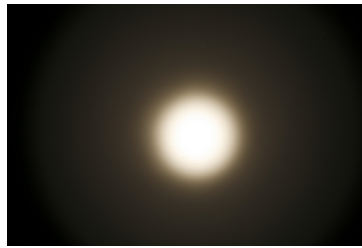

LED Soleriq S13  
 FWHM 14.0°  
 Efficiency 89 %  
 Peak intensity 6.200 cd/lm  
 LEDs/each optic 1  
 Light colour White  
 Required components:  
 C13709\_PF-SOCKET-VERO13-18  
 Bender Wirth: 437 Typ L1

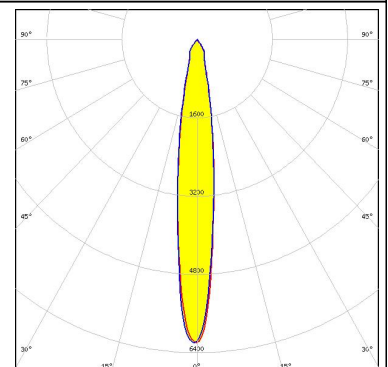
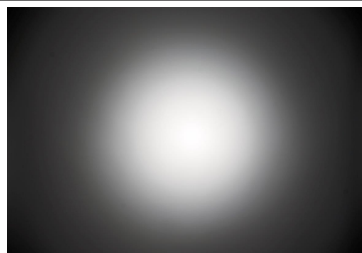

LED LC026B / 033B / 040B  
 FWHM 20.0°  
 Efficiency 88 %  
 Peak intensity 3.700 cd/lm  
 LEDs/each optic 1  
 Light colour White  
 Required components:  
 C13709\_PF-SOCKET-VERO13-18  
 Bender Wirth: 450 Typ L2

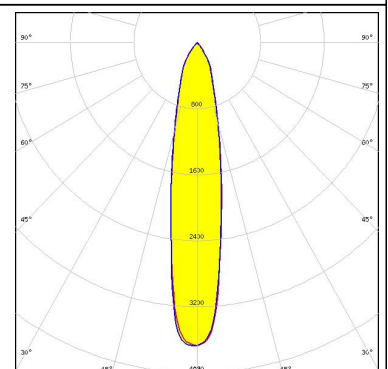
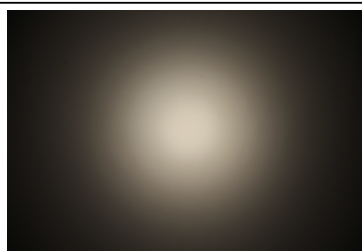

### PHOTOMETRIC DATA (MEASURED):

#### XICATO

LED XTM - 19mm LES  
FWHM 20.0°  
Efficiency 88 %  
Peak intensity 3.600 cd/lm  
LEDs/each optic 1  
Light colour White  
Required components:  
C14636\_XTM-PF-ADAPTER

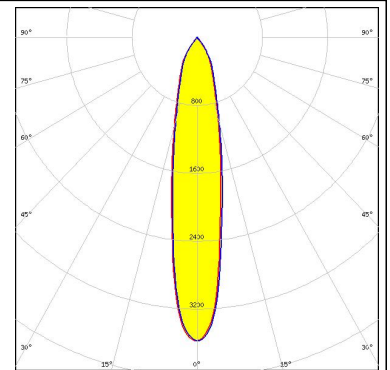

#### XICATO

LED XTM - 9mm LES  
FWHM 12.0°  
Efficiency 90 %  
Peak intensity 9.300 cd/lm  
LEDs/each optic 1  
Light colour White  
Required components:  
C14636\_XTM-PF-ADAPTER

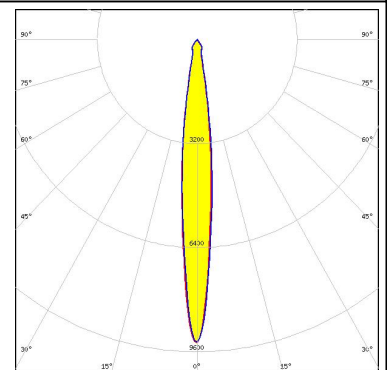

#### PHOTOMETRIC DATA (SIMULATED):

bridgelux.

LED V10 Gen7  
FWHM 12.0°  
Efficiency 91 %  
Peak intensity 9.440 cd/lm  
LEDs/each optic 1  
Light colour White  
Required components:  
C13709\_PF-SOCKET-VERO13-18  
Bender Wirth: 486 Typ L1

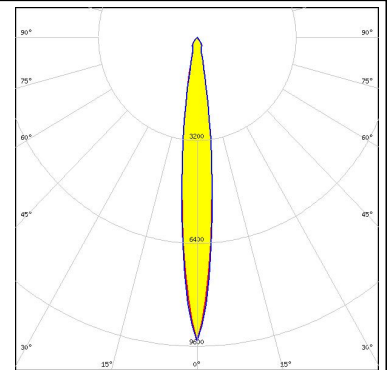

bridgelux.

LED VERO10  
FWHM 13.0°  
Efficiency 0 %  
Peak intensity 0.000 cd/lm  
LEDs/each optic 1  
Light colour White  
Required components:

bridgelux.

LED VERO13  
FWHM 15.0°  
Efficiency 0 %  
Peak intensity 0.000 cd/lm  
LEDs/each optic 1  
Light colour White  
Required components:

bridgelux.

LED VERO18  
FWHM 21.0°  
Efficiency 0 %  
Peak intensity 0.000 cd/lm  
LEDs/each optic 1  
Light colour White  
Required components:

## PHOTOMETRIC DATA (SIMULATED):



LED CXA/B 15xx  
FWHM 12.0°  
Efficiency 0 %  
Peak intensity 0.000 cd/lm  
LEDs/each optic 1  
Light colour White  
Required components:



LED LUXEON CoB Compact  
FWHM 9.0°  
Efficiency 90 %  
Peak intensity 19.600 cd/lm  
LEDs/each optic 1  
Light colour White  
Required components:  
C13761\_PF-SOCKET-CXA15



LED CxM-14 (19x19)  
FWHM 16.0°  
Efficiency 88 %  
Peak intensity 5.130 cd/lm  
LEDs/each optic 1  
Light colour White  
Required components:  
C13709\_PF-SOCKET-VERO13-18  
Bender Wirth: 433 Typ L1



LED CxM-9 (13.5x13.5)  
FWHM 12.0°  
Efficiency 89 %  
Peak intensity 9.200 cd/lm  
LEDs/each optic 1  
Light colour White  
Required components:  
C13709\_PF-SOCKET-VERO13-18  
Bender Wirth: 434 Typ L1

#### PHOTOMETRIC DATA (SIMULATED):

#### OSRAM

Opto Semiconductors

LED Soleriq S15  
 FWHM 20.0°  
 Efficiency 88 %  
 Peak intensity 4.013 cd/lm  
 LEDs/each optic 1  
 Light colour White  
 Required components:  
 C13709\_PF-SOCKET-VERO13-18  
 Bender Wirth: 433 Typ L1

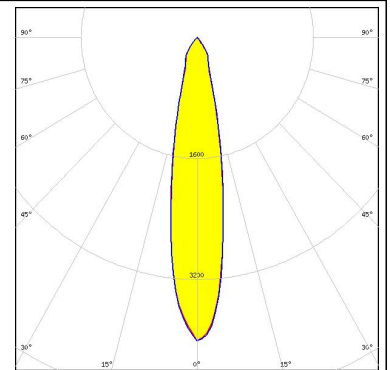

#### SAMSUNG

LED LC010C  
 FWHM 9.1°  
 Efficiency 89 %  
 Peak intensity 16.300 cd/lm  
 LEDs/each optic 1  
 Light colour White  
 Required components:  
 C13709\_PF-SOCKET-VERO13-18  
 Bender Wirth: 479 Typ L1

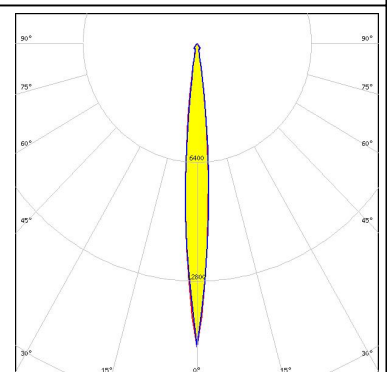

#### SAMSUNG

LED LC020C  
 FWHM 10.0°  
 Efficiency 89 %  
 Peak intensity 12.300 cd/lm  
 LEDs/each optic 1  
 Light colour White  
 Required components:  
 C13709\_PF-SOCKET-VERO13-18  
 Bender Wirth: 479 Typ L1

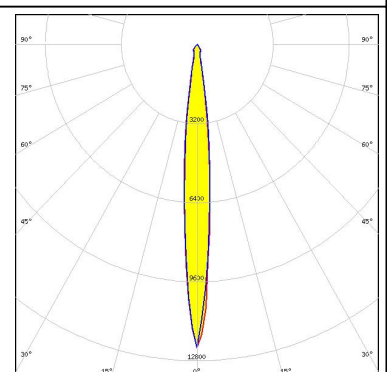

#### SAMSUNG

LED LC040C  
 FWHM 13.0°  
 Efficiency 85 %  
 Peak intensity 7.300 cd/lm  
 LEDs/each optic 1  
 Light colour White  
 Required components:  
 C13709\_PF-SOCKET-VERO13-18  
 Bender Wirth: 480 Typ L1

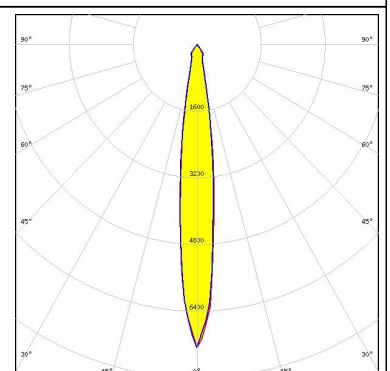

## PHOTOMETRIC DATA (SIMULATED):

	
SEOUL SEMICONDUCTOR	
LED	ZC12/18
FWHM	16.0°
Efficiency	88 %
Peak intensity	5.100 cd/lm
LEDs/each optic	1
Light colour	White
Required components:	
C13709_PF-SOCKET-VERO13-18	
Bender Wirth: 433 Typ L1	
<hr/>	
	
SEOUL SEMICONDUCTOR	
LED	ZC4/6
FWHM	12.0°
Efficiency	89 %
Peak intensity	9.200 cd/lm
LEDs/each optic	1
Light colour	White
Required components:	
C13709_PF-SOCKET-VERO13-18	
Bender Wirth: 434 Typ L1	

### GENERAL INFORMATION:

NOTE: The typical beam angle will be changed by different color, chip size and chip position tolerance. The typical total beam angle is the full angle measured where the luminous intensity is half of the peak value.

Due to use of high power COB's with this product, special attention to proper thermal design is highly recommended. LEDiL has no liability for direct, indirect or consecutive damages arising from the LEDiL products being used outside of the recommended temperature range.

### MATERIALS:

As part of our continuous research and improvement processes, and to ensure the best possible quality and availability of our products, LEDiL reserves the right to change material grades without notice.

### PRODUCT DATA USER AGREEMENT AND DISCLAIMER:

The measured data in the provided downloadable LEDiL Product Datasheets and Mechanical 2D-Drawings is rounded and provided as reference for planning. LEDiL Oy's optical specifications have been verified by conducting performance testing of the products in accordance with the company's quality system. The reported data are averaged results of multiple measurements with typical variation. LEDiL Oy reserves the right to without prior notification make changes and improvements to its products.

LEDiL Oy assumes neither warranty, nor guarantee nor any other liability of any kind for the contents and correctness of the provided data. The provided data has been generated with highest diligence but the provided data may in reality not represent the complete possible variation range of all intrinsic parameters. Therefore, in certain cases a deviation from the provided data could occur.

LEDiL Oy reserves the right to undertake technical changes of its products without further notification which could lead to changes in the provided data. LEDiL Oy assumes no liability of any kind for the possible deviation from any provided data or any other damage resulting from the usage of the provided data.

The user agrees to this disclaimer and user agreement with the download or usage of the provided files.

#### LEDiL Oy

Joensuunkatu 13  
FI-24240 SALO  
Finland

#### LEDiL Inc.

228 West Page Street  
Suite D  
Sycamore IL 60178  
USA

#### Local sales and technical support

[www.ledil.com/where\\_to\\_buy](http://www.ledil.com/where_to_buy)

#### Shipping locations

Salo, Finland  
Hong Kong, China

#### Distribution Partners

[www.ledil.com/where\\_to\\_buy](http://www.ledil.com/where_to_buy)