

- > **Port size: G1/8 & G1/4**
- > **Very compact unit**
- > **Universal useable**



Technical features

Medium:

Compressed air only

Maximum inlet pressure:

20 bar (290 psi)

Pressure range:

 0,3 ... 7 bar (4 ... 101 psi),
 0,3 ... 3,5 bar (4 ... 50 psi),
 0,1 ... 0,7 bar (1 ... 10 psi),
 0,3 ... 10 bar (4 ... 145 psi)

Flow:

see below

Port sizes:

 G1/8 or G1/4
 Rc1/8 (Gauge)

Ambient/Media temperature:

-34 ... +65°C (-29 ... +149°F)

 Air supply must be dry enough to
 avoid ice formation at temperatures
 below +2°C (+35°F)

Materials:

 Body: Zinc alloy
 Bonnet and knob: Acetal
 Valve: Brass
 Seals: NBR

Technical data, standard models with relieving

Symbol	Port size	Pressure range (bar)	Flow *1) (dm ³ /s)	Weight (kg)	Model
	G1/8	0,3 ... 7	6,5	0,19	R07-100-RNKG
	G1/4	0,3 ... 7	7	0,19	R07-200-RNKG

*1) Flow at inlet pressure 10 bar (145 psi), outlet pressure 6,3 bar (91 psi) and pressure drop 1 bar (14 psi)

Option selector

R07-★0★-★★★★

Port size	Substitute	Thread	Substitute
1/8"	1	PTF	A
1/4"	2	ISO G	G
Option	Substitute	Pressure range (bar) *1)	Substitute
Standard	0	0,1 ... 0,7	A
Pressure range 10 bar	5	0,3 ... 3,5	E
		0,3 ... 7	K
		0,3 ... 10	M *2)
		Gauge	Substitute
		With	G
		Without	N
		Diaphragm	Substitute
		Relieving	R
		Non-relieving	N

*1) Outlet pressure can be adjusted to pressures in excess of and less than, those specified. Do not use these units to control pressures outside of the specified ranges.

*2) When specifying 10 bar (145 psi) unit, eg. R07-205-RNMG, also note correct code at 6th digit.

Flow characteristics

Port size 1/4", Pressure range 0,3 ... 7 bar

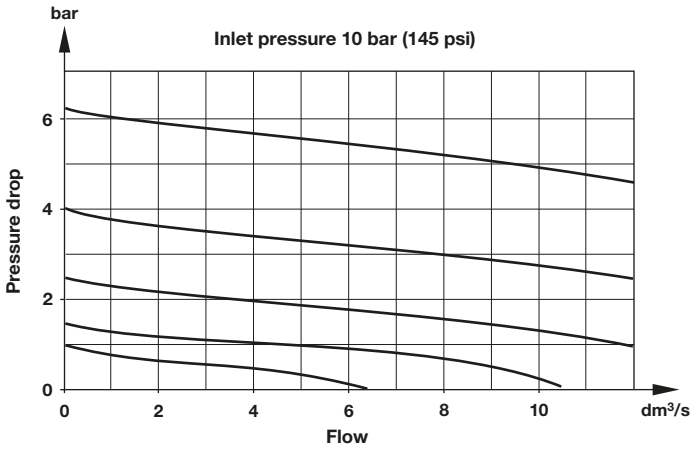



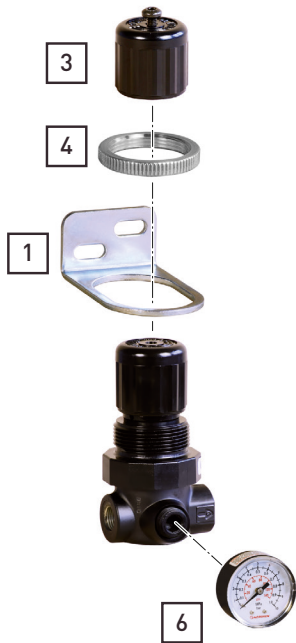

Accessories



Service kit



Wall mounting bracket and panel nut	Panel nut	Tamper resistant field modification	Gauge ø 40 mm
 1 & 4	 4	 3	 6
18-025-003 (with plastic nut) 18-025-004 (with metal nut)	2962-04 (Metal) 2962-89 (Plastic)	18-001-092	18-013-990 (0 ... 4 bar) 18-013-989 (0 ... 10 bar (145 psi))

Dimensions
Bracket mounting

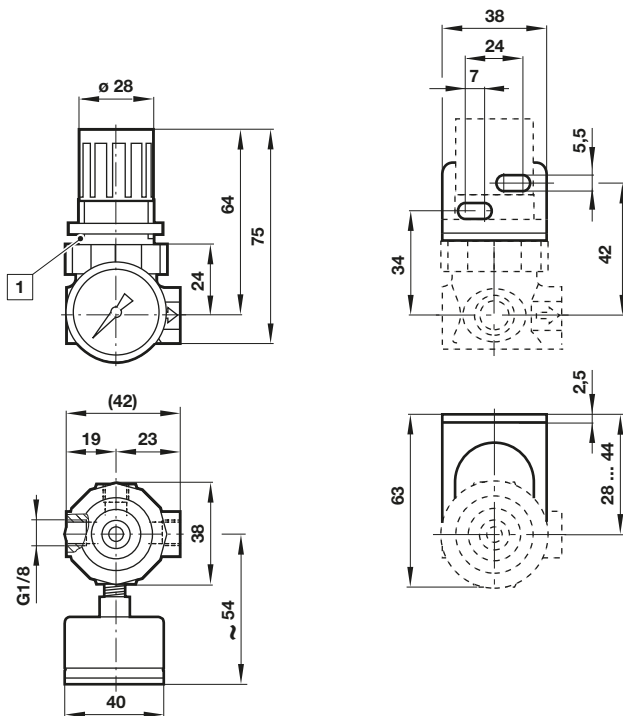
 Dimensions in mm
 Projection/First angle

 1 Panel mounting hole \varnothing 31 mm

Warning

These products are intended for use in industrial compressed air systems only. Do not use these products where pressures and temperatures can exceed those listed under

»Technical features/data«.

Before using these products with fluids other than those specified, for non-industrial applications, life-support systems or other applications not within published specifications, consult IMI Precision Engineering, Norgren GmbH.

Through misuse, age, or malfunction, components used in fluid power systems can fail in various modes.

The system designer is warned to consider the failure modes of all component parts used in fluid power systems and to provide adequate safeguards to prevent personal injury or damage to equipment in the event of such failure.

System designers must provide a warning to end users in the system instructional manual if protection against a failure mode cannot be adequately provided.

System designers and end users are cautioned to review specific warnings found in instruction sheets packed and shipped with these products.