

M12 MALE 0° SHIELDED

PUR 4X0.34 shielded GRAY, 3m

M12

Male straight

4-pole, shielded

Plastic housings with good resistance against chemicals and oils. The resistance to aggressive media should be individually tested for your application. Further details on request. Further cable lengths on request.

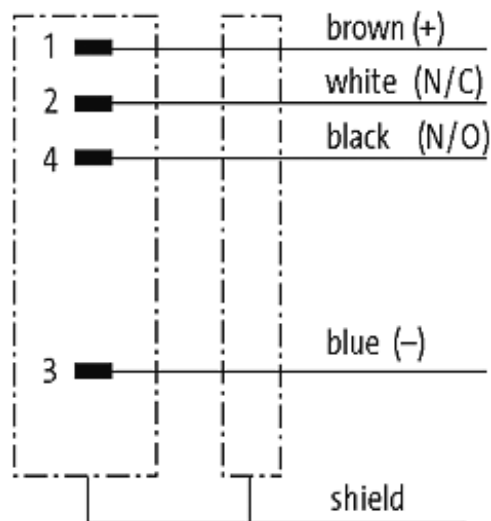
[Link to Product](#)**Illustration**

Male

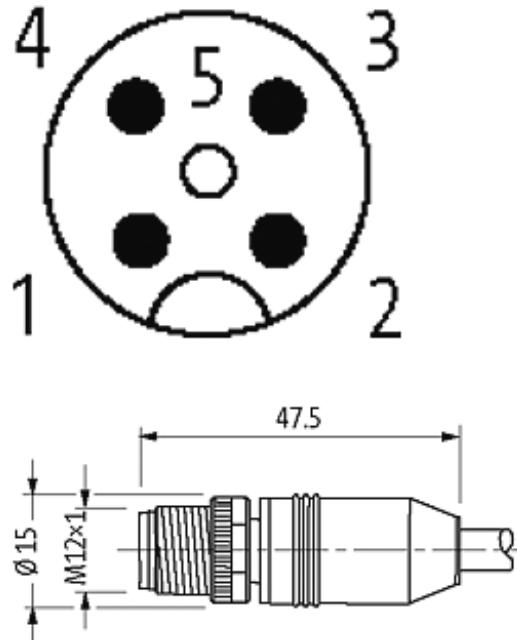

Product may differ from Image

Approvals



Form

13081

Technical Data

Operating voltage	max. 60 V AC/DC
Operating current per contact	max. 4 A
Locking of ports	Screw thread M12 × 1 mm (recommended torque 0.6 Nm) self-securing
Protection	IP67 inserted and tightened (EN 60529)

Cables

Cable number	331
No./diameter of wires	4 × 0.34 mm ²
Wire isolation	PVC (br, wh, bl, bk)
Jacket Color	gray
Shore hardness outer jacket	85 ± 5A
Material (jacket)	PUR/PVC
Outer diameter	approx. 5.9 mm

The information in this brochure has been compiled with the utmost care.

Liability for the correctness completeness and topicality of the information is restricted to gross negligence. Version: 05/15

Bend radius (fixed)	10 × outer Ø
Bend radius (moving)	15 × outer Ø
Temperature range (fixed)	-30...+80 °C
Temperature range (mobile)	-5...+70 °C
Shielded	yes

General data

Temperature range	-25...+85 °C, depending on cable quality
-------------------	--

Commercial data

country of origin	DE
customs tariff number	85444290
minimum order quantity	1