

LOW-PROFILE SLIDE SWITCHES

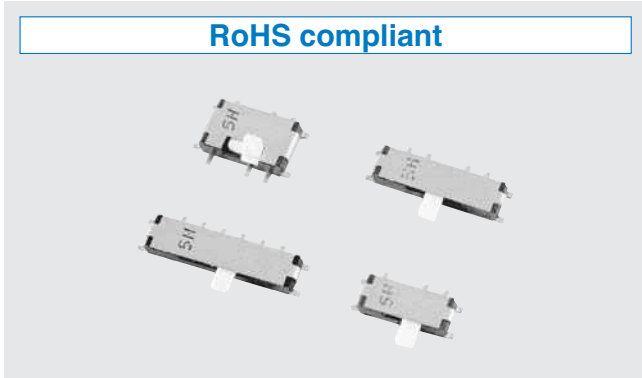

RoHS compliant



FEATURES

- Low-profile of 1.4 mm
- RoHS compliant

APPLICATIONS

- Mobile stereo · LCD TV · Camcorder

INTERNAL STRUCTURE

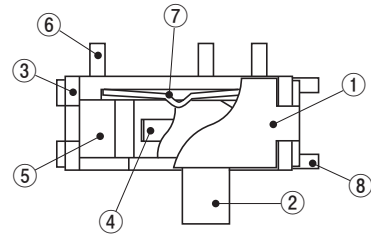

Part name	Material	Flammability
① Cover	Nickel silver	—
② Slider	Polyamide	UL94V-0
③ Housing	Liquid crystal polymer	
④ Slider contact	Copper alloy, Gold-plated	—
⑤ Fixed contact		
⑥ Terminal pin	Stainless steel (SUS 301)	—
⑦ Click spring		
⑧ Ground terminal	Nickel silver	—

PART NUMBER DESIGNATION

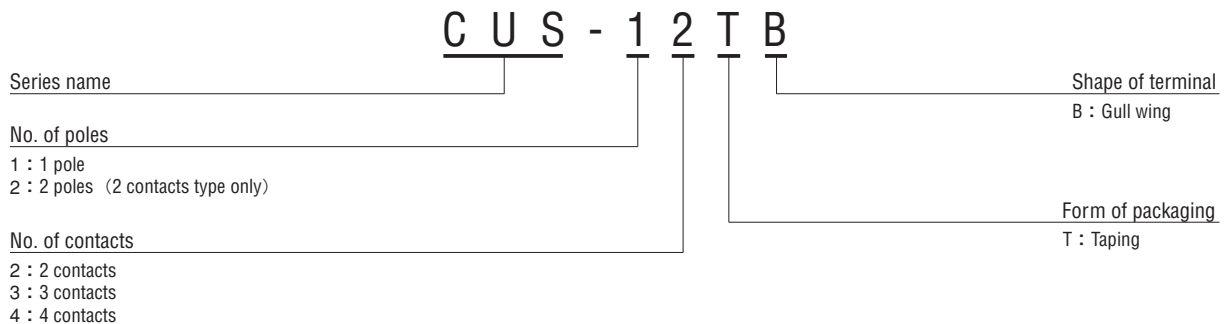

※ Please refer to the LIST OF PART NUMBERS when placing orders.

CUS

LOW-PROFILE SLIDE SWITCHES

LIST OF PART NUMBERS

Schematic	No. of contacts	Shape of terminal	Form of packaging	Part number	Pieces in package
1	2	B (Gull wing)	Taping	CUS-12TB	2500 pcs./reel
	3			CUS-13TB	
	4			CUS-14TB	
2	CUS-22TB			1400 pcs./reel	

STANDARD SPECIFICATIONS

Operating temp. range	- 20 ~ 70 °C
Storage temp. range	- 40 ~ 85 °C
Sealing	Non washable
Net weight	Approx. 0.08 g (CUS-12) Approx. 0.10 g (CUS-13) Approx. 0.13 g (CUS-14) Approx. 0.11 g (CUS-22)

ELECTRICAL CHARACTERISTICS

Contact rating Non-switching Switching Minimum	DC50 V 100 mA DC4 V 300 mA DC20 mV 1 μA
Contact timing	Non-shorting
Contact resistance	70 mΩ maximum
Insulation resistance	100 MΩ minimum (DC 100 V)
Dielectric strength	AC100 V 60 s

MECHANICAL CHARACTERISTICS

No. of positions	2, 3, 4	
Stroke	1.5 mm	
Operating force	CUS-12 ^{※1}	2 ± 1.7 N {0.2 ± 0.17 kgf}
	CUS-13 ^{※2}	A → B : 1.5 ± 1.2 N {0.15 ± 0.12 kgf}
		B → C : 2 ± 1.7 N {0.2 ± 0.17 kgf}
		C → B : 1.5 ± 1.2 N {0.15 ± 0.12 kgf}
	CUS-14 ^{※3}	A → B : 1.5 ± 1.2 N {0.15 ± 0.12 kgf}
		B → C : 2 ± 1.7 N {0.2 ± 0.17 kgf}
C → D : 2 ± 1.7 N {0.2 ± 0.17 kgf}		
D → C : 1.5 ± 1.2 N {0.15 ± 0.12 kgf}		
CUS-22 ^{※4}	2 ± 1.7 N {0.2 ± 0.17 kgf}	
Stop strength	10 N {1.02 kgf} 15 s	
Solderability	245 ± 3 °C 2 ~ 3 s	
Soldering heat	Reflow peak : 250 ~ 255 °C	
	Manual soldering : 350 ± 10 °C 3 ~ 4 s	
Shear	5 N {0.5 kgf} 10 s	
Substrate bending	Width 90 mm, bend 3 mm, 5 s, 1 time	
Pull-off strength	5 N {0.5 kgf} 10 s	

{ } : Reference only

ENVIRONMENTAL CHARACTERISTICS

Vibration	Amplitude 1.5 mm or Acceleration 98 m/s ² , 10-500-10 Hz, 3 directions for 10 cycles each
Shock	490 m/s ² , 11 ms, 6 directions for 3 times each
Load life	Continuous load 10000 cycles, DC4 ± 0.5 V, 300 ± 10 mA
Humidity	40 °C, Relative humidity 90 ~ 95 %, 240 h, No load
High temp. exposure	85 °C, 96 h, No load
Low temp. exposure	-40 °C, 96 h, No load
Thermal shock	-40 (0.5 h) ~ 85 °C (0.5 h), 5 cycles

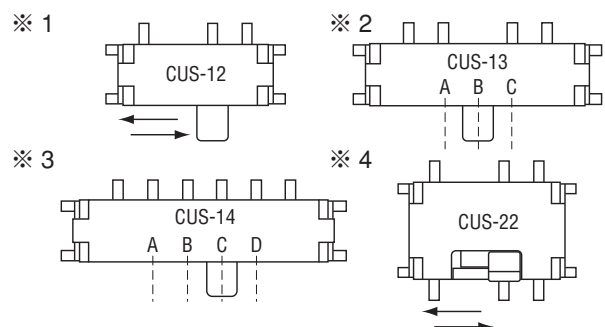

CUS

LOW-PROFILE SLIDE SWITCHES

OUTLINE DIMENSIONS

Unless otherwise specified, tolerance : ± 0.2 (Unit : mm)

● CUS-12B

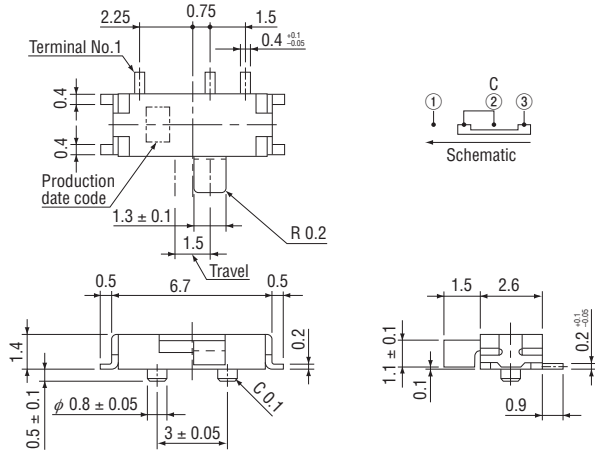

● CUS-13B

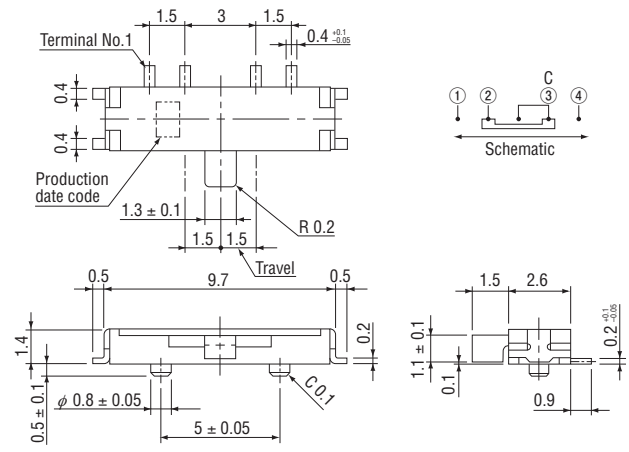

● CUS-14B

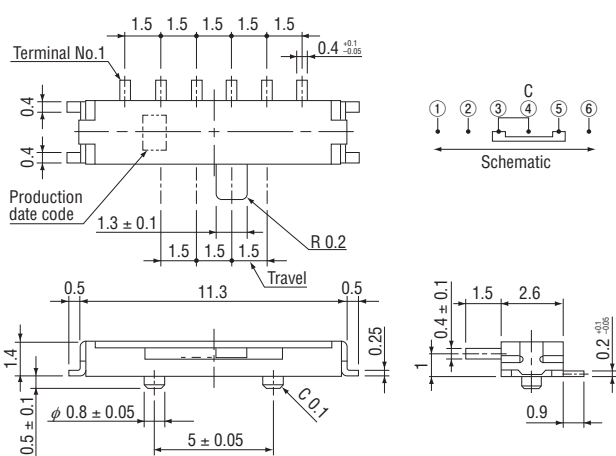

● CUS-22B

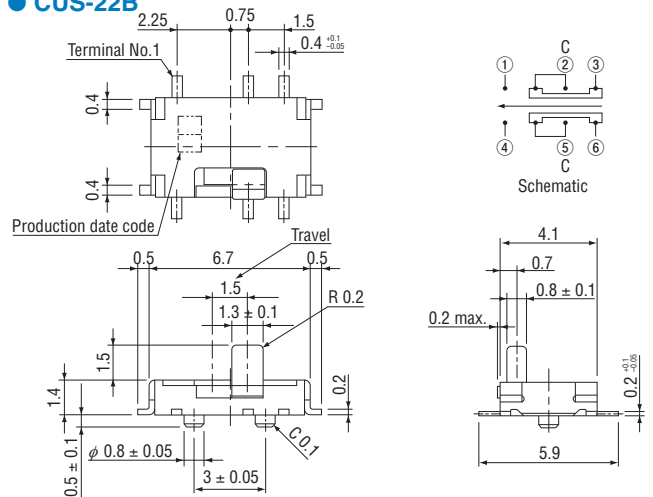

RECOMMENDED P.C.B. PAD OUTLINE DIMENSIONS

(Unit : mm)

● CUS-12B

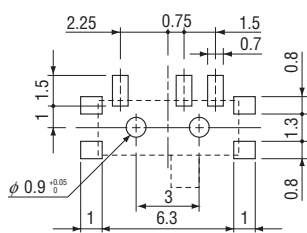

● CUS-13B

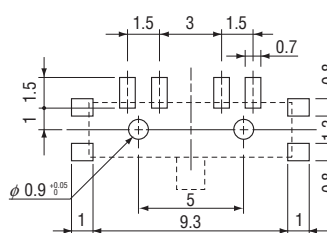

● CUS-14B

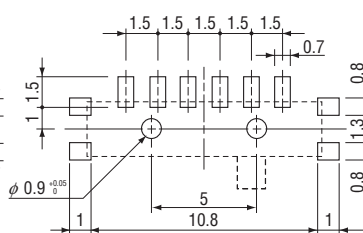

● CUS-22B

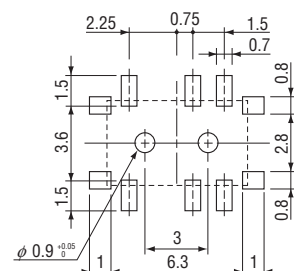

CUS

LOW-PROFILE SLIDE SWITCHES

PACKAGING SPECIFICATIONS

Taping version is packaged in 2500 pcs. per reel (1400 pcs. for CUS-22).

Taping version is boxed with 1 reel (2500 pcs. or 1400 pcs.).
 Maximum number of consecutive missing pieces = 2. Leader length and reel dimension are shown in the diagrams below.

Embossed tape dimensions

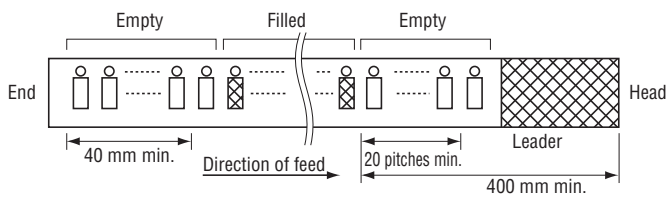

● CUS-12TB

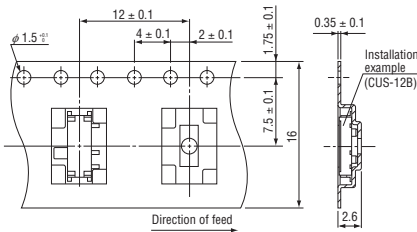

● CUS-13TB, CUS-14TB

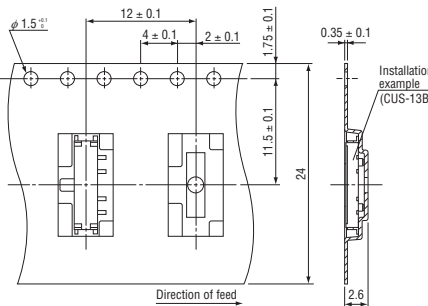

● CUS-22TB

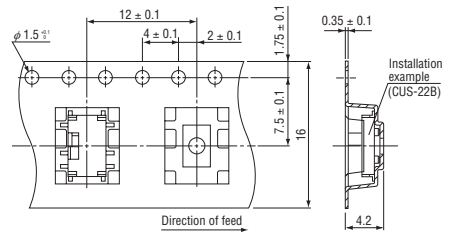

● Reel dimensions

(Unit: mm)

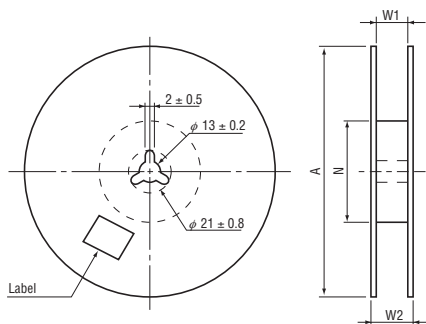

Part number	A	W ₁	W ₂	N
12TB, 22TB	φ 330 ± 2	17.4 ± 1	21.4 ± 1	φ 80 ± 1
13TB, 14TB	φ 330 ± 2	25.4 ± 1	29.4 ± 1	φ 80 ± 1