

SAI Passive SAI-6-MH-5P M12

Weidmüller Interface GmbH & Co. KG
 Klingenbergstraße 16
 D-32758 Detmold
 Germany
 Fon: +49 5231 14-0
 Fax: +49 5231 14-292083
 www.weidmueller.com



Cable gland: M25 for cables with an outer insulation diameter from 13 mm to 18 mm. The SAI distributor with M25 cable gland is suitable among others for the following cable types:

- 21 x 0.50 mm
- 18 x 0.75 mm bis 21 x 0.75 mm
- 14 x 100 mm bis 20 x 100 mm
- 8 x 1.50 mm bis 16 x 1.50 mm

General ordering data

Type	SAI-6-MH-5P M12
Order No.	1701242000
Version	SAI Passive, Sensor-actuator passive distributor, M12, Hood version with M20 outlet, Yes
GTIN (EAN)	4032248184484
Qty.	1 pc(s).

SAI Passive SAI-6-MH-5P M12

Weidmüller Interface GmbH & Co. KG
 Klingenbergstraße 16
 D-32758 Detmold
 Germany
 Fon: +49 5231 14-0
 Fax: +49 5231 14-292083
 www.weidmueller.com

Technische Daten

Dimensions and weights

Length	127 mm	Width	60 mm
Height	55 mm	Net weight	100 g

General data

Connection type PE	Screw connection	Number of contact sockets	6
Fire behaviour	V-0	Contact tube diameter	M12
No. of poles	5	Storage space	gross
Plugging cycles	≤ 50	Pollution severity	3
Cable gland	M 20	Distributor outlet	Hood version with M20 outlet
Insulation resistance	10 ⁹ Ω	Rated voltage , max.	30 V
Rated voltage , min.	10 V	Electrical isolation available	Yes
Test voltage	1 kV	Current per signal	2 A
Total current	10 A	Max. current-carrying capacity per slot	4 A
Housing main material	Pocan (base module), Zinc diecast (hood)	Housing colour	Silver
Screw socket	CuZn, nickel-plated	Hood sealing material	Foamed PUR
Contact material	CuZn	Contact surface	Gold-plated
Contact carrier material	PBT (UL 94 V0)	Clamping range, rated connection, max.	1.5 mm ²
Clamping range, rated connection, min.	0.08 mm ²	Conductor O.D.	10 - 14mm
Conductor O.D., max.	14 mm	Conductor O.D., min.	10 mm
LED initiator	Yes	LED	Yes
LED colour for indicating operation	green	LED colour for I/O function	yellow

Classifications

ETIM 3.0	EC001856	UNSPSC	30-21-18-01
eClass 6.2	27-06-91-90	eClass 7.1	27-06-91-90

Approvals

Approvals



ROHS Conform

**SAI Passive
SAI-6-MH-5P M12**

Weidmüller Interface GmbH & Co. KG
 Klingenbergstraße 16
 D-32758 Detmold
 Germany
 Fon: +49 5231 14-0
 Fax: +49 5231 14-292083
 www.weidmueller.com

Zeichnungen

Dimensioned drawing

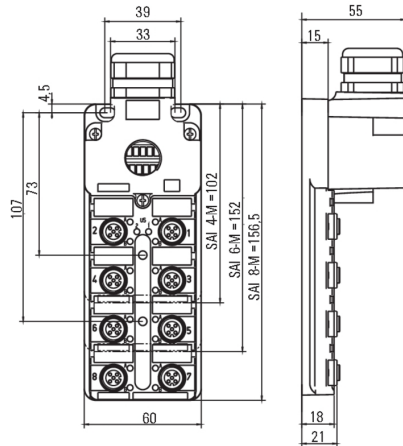

Circuit diagram

