



EVERLIGHT ELECTRONICS CO.,LTD.

Device Number : DLE-038-124 REV: 1.0

T-1 3/4(5mm) High Intensity LEDs

MODEL NO : 383-2SYGC/S530-E2 ECN : _____ Page: 1/4

Features :

- Popular T-1 3/4 diameter package.
- Choice of various viewing angles.
- Available on tape and reel.
- Reliable and robust.

Description :

- The series is specially designs for applications require higher brightness than that achievable with standard lamp.
- The LED lamps are available with different colors,intensities, epoxy colors, etc.

Package Dimension:

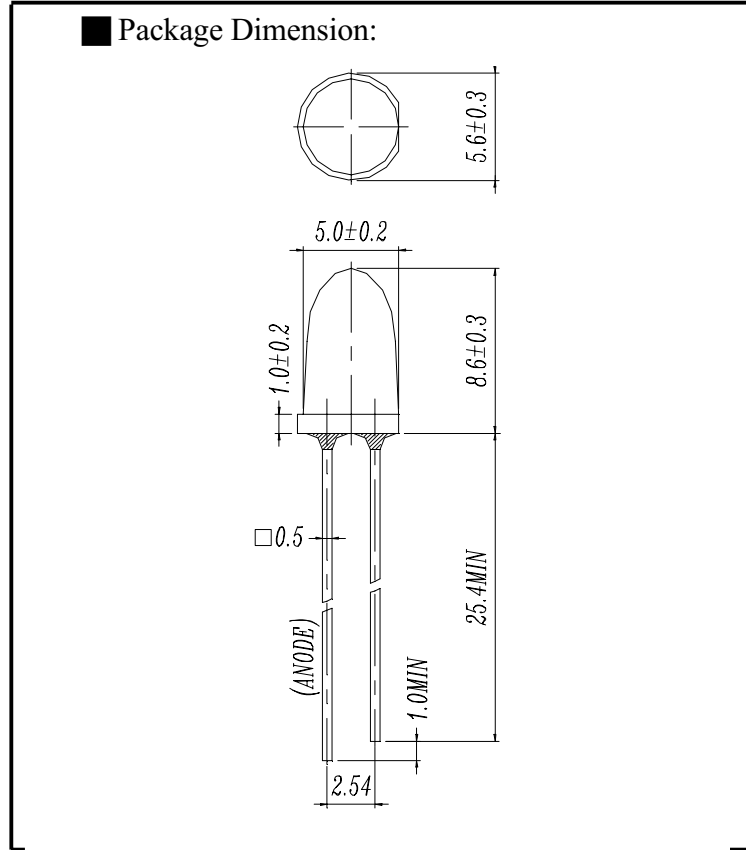

Applications :

- TV Set
- Monitor
- Telephone
- Computer

NOTES :

- 1.All dimensions are in millimeter.
- 2.An epoxy meniscus may extend about 1.5mm(0.059") down to the lead.

PART NO	CHIP		Lens Color
	Material	Emitted Color	
383-2SYGC/S530-E2	AlGaInP	Super Yellow Green	Water Clear

DESIGNER	CHECKER	APPROVER

Office : NO 25,Lane 76,Chung Yang Rd,Sec.3
Tucheng,Taipei 236,Taiwan,R.O.C.

TEL : 886-2-2267-2000,2267-9936(22 Lines)
FAX : 886-2-2267-6189



EVERLIGHT ELECTRONICS CO.,LTD.

Device Number : DLE-038-124 REV: 1.0

T-1 3/4 (5mm) Round Shape LEDs

MODEL NO : 383-2SYGC/S530-E2 ECN : _____ Page: 2/4

Absolute Maximum Ratings at T_A = 25°C

Parameter	Symbol	Rating	Unit
Forward Current	I _f	25	mA
Operating Temperature	T _{opr}	-40 to +85	°C
Storage Temperature	T _{stg}	-40 to +100	°C
Soldering Temperature	T _{sol}	260 ± 5	°C
Power Dissipation	P _d	60	mW
Peak Forward Current(Duty 1/10 @ 1KHZ)	I _{f(peak)}	120	mA
Reverse voltage	V _r	5	V

Electronic Optical Characteristics :

Parameter	Symbol	MIN.	TYP.	MAX.	Unit	Condition
Luminous intensity	I _v	---- 590	48 810	-----	mcd	I _f =2mA I _f =20mA
Viewing Angle	2 θ 1/2	----	6	----	deg	I _f =20mA
Peak Wavelength	λ _p	----	575	-----	nm	I _f =20mA
Dominant Wavelength	λ _d	----	573	----	nm	I _f =20mA
Spectrum Radiation Bandwidth	Δ λ	---	20	----	nm	I _f =20mA
Forward Voltage	V _f	----	2.0	2.4	V	I _f =20mA
Reverse Current	I _r	----	----	10	μ A	V _r =5V



Device Number : DLE-038-124 REV: 1.0

T-1 3/4(5mm) High Intensity LEDs

MODEL NO 383-2SYGC/S530-E2 ECN : _____ Page: 3/4

■ Typical Electro-Optical Characteristic Curves

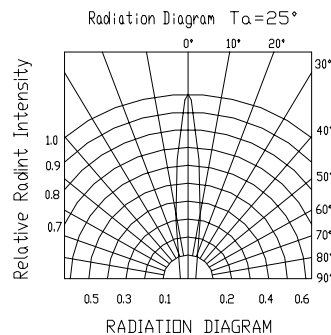
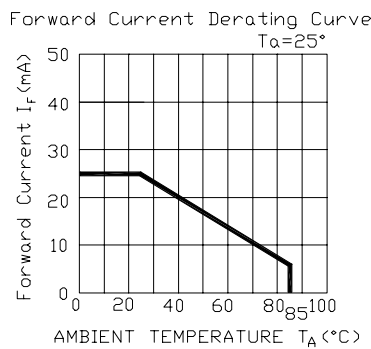
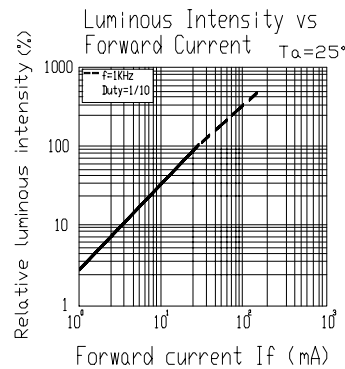
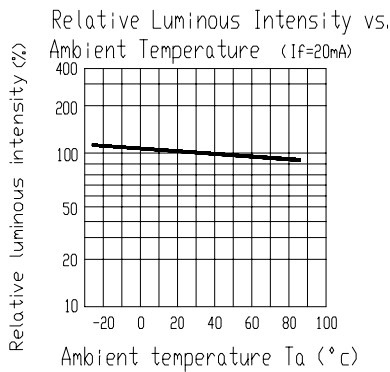
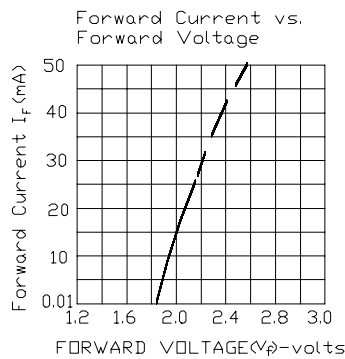
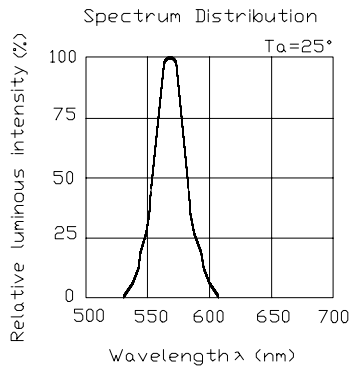



EVERLIGHT ELECTRONICS CO.,LTD.

Device Number : DLE-038-124

REV: 1.0

T-1 3/4 (5mm) Round Shape LEDs

MODEL NO 383-2SYGC/S530-E2

ECN:

Page: 4/4

■ Reliability test items and conditions

NO	Item	Test Conditions	Test Hours/Cycle	Sample Size	Ac/Re
1	Soldering Heat	TEMP : 260°C ± 5 °C	10±1 SEC	76 Pcs	0/1
2	Solderability	TEMP : 230°C ± 5 °C	5±1 SEC	76 Pcs	0/1
3	Temperature Cycle	H : +85°C 30min ∫ 5 min L : -55°C 30min	50 CYCLE	76 Pcs	0/1
4	Thermal Shock	H : +100°C 5min ∫ 10 sec L : -10°C 5min	50 CYCLE	76 Pcs	0/1
5	High Temperature Storage	TEMP : 100°C	1000 HRS	76 Pcs	0/1
6	Low Temperature Storage	TEMP : -55°C	1000 HRS	76 Pcs	0/1
7	DC Operating Life	If = 20 mA	1000 HRS	76 Pcs	0/1
8	High Temperature / High Humidity	85°C/85% RH	1000 HRS	76 Pcs	0/1