

No.	Changes and/or Note No.	Date	Intr	No	Changes and/or Note No.	Date	Intr

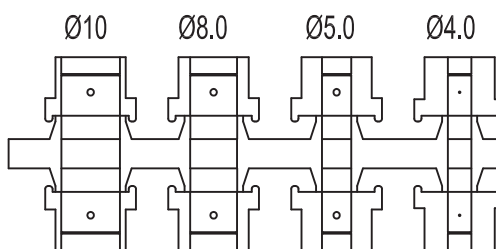
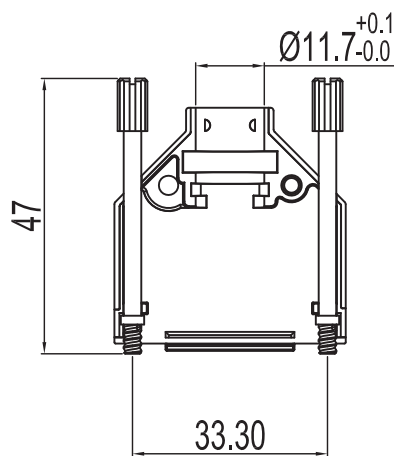
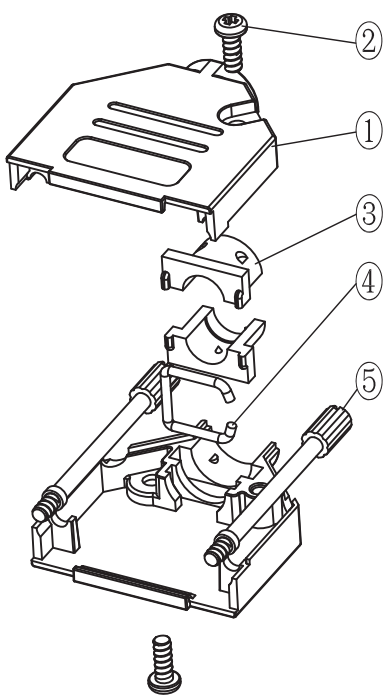
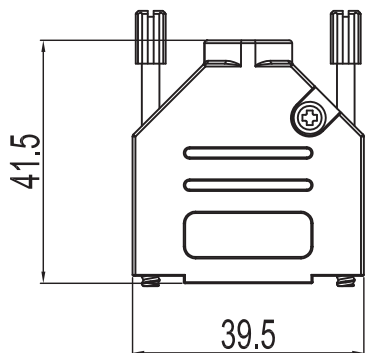

Grommet Set

Part Number:	Description:	Pack:	Item	QTY	Part description
6560-0805-02	DTCK15-K	Kit	1	2	DTCK-15 cover
6561-0805-02	DTCK15	Bulk	2	2	M3x10 Screw
			3	1	DTZK-D1 Grommet set
			4	1	C CLIP Clamp
			5	2	UNC 4-40X47 Jackscrew
DATE: 2011-04-26	DRAWN: MRR	SCALE:	MATERIAL TYPE:		GENERAL TOLERANCES UNLESS OTHERWISE STATED LINEAR 0 ±0.20 0.0 ±0.15 0.00 ±0.10 ANGULAR =0°30' ALL DIMENSIONS IN mm THIRD ANGLE PROJECTION
	APPROVED:		REPLACES:		
			DIECAST HOODS DTCK-SERIES		
			DRAWING No: 6688-9552		