



US Catalog | December 2016

# Miniature Circuit Breakers





# Miniature circuit breakers

## Table of contents

### S(U)200 series miniature circuit breakers

#### UL 489 series

Description and features	2
SU200M-C	3
SU200M-K	4
SU200M-Z	5
SU200MR-K	6
S200UDC-K	7
S200UDC-Z	8
Accessories	9
Technical specifications	14
Approximate dimensions	18

### S200 series miniature circuit breakers

#### UL 1077 series

Description and features	19
S200-B	20
S200-C	21
S200-D	22
S200-K	23
S200-Z	24
S200P-B	25
S200P-C	26
S200P-D	27
S200P-K	28
S200P-Z	29
S200MR-K	30
S200MUC-C	31
S200MUC-K	32
S200MUC-Z	33
Accessories	34
Technical specifications	38
S200MUC uses	40
Approximate dimensions	41

### Application guide

Introduction, overload, short circuit, breaker definition	42
Circuit breaker construction	43
Circuit breaker current limitation	45
Selective coordination and series ratings	47
Miniature circuit breaker cutaway	49

### S800U series miniature circuit breakers

#### UL 489 series

Description and features	50
S800U-K	51
S800U-Z	52
S804U-PVS5	53
S804U-UCZ	55
S803W-SCL-SR UL Short circuit current limiter	57
S800W-RSU Remote switching unit	59
Accessories	60
Technical specifications	62
Approximate dimensions	66

### S500 series miniature circuit breakers

#### UL 1077 series

Description and features	68
S500-K	69
S500UC-B	70
S500UC-K	71
Accessories	72
Technical specifications	73
Approximate dimensions	74

# S(U)200 series – SU200M, SU200MR, and S200UDC UL 489 series



## Description

The SU200M, SU200MR, and S200UDC miniature circuit breakers offer a compact solution for protection requirements. The SU200 series devices are current-limiting according to UL 489 and DIN rail mounted.

SU200M, SU200MR, and S200UDC MCBs come in up to 3 trip curves to provide maximum circuit protection.

For the worldwide market, the breakers carry UL, CSA, IEC, CE and many other agency approvals and certifications.

## Features

- UL current limiting
- Fast breaking time (2.3 – 2.5 ms)
- Bus connection system
- Wide range of accessories
- Available with variable depth handle mechanism
- CE certified and marked
- DIN rail mounting
- Finger safe terminals
- Multi-function terminals
- Suitable for reverse feed (except for S200UDC)
- UL 489 Listed - branch circuit protective device  
UL File #E212323

	SU200M	SU200MR	S200UDC
<b>Amperage</b>	0.2-63	0.2-63	1-63
<b>Voltage</b>	up to 277/Y480 VAC 48/96 VDC	up to 277/480 VAC	60/125 VDC
<b>Trip curves</b>	Z, C, K	K	Z, K
<b>Interrupt rating</b>	10 kA-	10 kA	14 kA
<b>Auxiliary contacts</b>	Yes	Yes	Yes
<b>Bell alarm</b>	Yes	Yes	Yes
<b>Shunt trip</b>	Yes	Yes	Yes
<b>Busbar</b>	Yes	Yes	Yes



# SU200M-C

## Branch circuit protection—UL 489, CSA 22.2 No. 5



Number of poles	Rated current		Catalog number	Number of poles	Rated current		
	$I_n$	A			$I_n$	A	Catalog number
1	0.5		SU201M-C0.5	3	0.5		SU203M-C0.5
	1		SU201M-C1		1		SU203M-C1
	1.6		SU201M-C1.6		1.6		SU203M-C1.6
	2		SU201M-C2		2		SU203M-C2
	3		SU201M-C3		3		SU203M-C3
	4		SU201M-C4		4		SU203M-C4
	5		SU201M-C5		5		SU203M-C5
	6		SU201M-C6		6		SU203M-C6
	7		SU201M-C7		7		SU203M-C7
	8		SU201M-C8		8		SU203M-C8
	10		SU201M-C10		10		SU203M-C10
	13		SU201M-C13		13		SU203M-C13
	15		SU201M-C15		15		SU203M-C15
	16		SU201M-C16		16		SU203M-C16
	20		SU201M-C20		20		SU203M-C20
	25		SU201M-C25		25		SU203M-C25
	30		SU201M-C30		30		SU203M-C30
	32		SU201M-C32		32		SU203M-C32
35		SU201M-C35	35		SU203M-C35		
40		SU201M-C40	40		SU203M-C40		
50		SU201M-C50	50		SU203M-C50		
60		SU201M-C60	60		SU203M-C60		
63		SU201M-C63	63		SU203M-C63		
2	0.5		SU202M-C0.5	4	0.5		SU204M-C0.5
	1		SU202M-C1		1		SU204M-C1
	1.6		SU202M-C1.6		1.6		SU204M-C1.6
	2		SU202M-C2		2		SU204M-C2
	3		SU202M-C3		3		SU204M-C3
	4		SU202M-C4		4		SU204M-C4
	5		SU202M-C5		5		SU204M-C5
	6		SU202M-C6		6		SU204M-C6
	7		SU202M-C7		7		SU204M-C7
	8		SU202M-C8		8		SU204M-C8
	10		SU202M-C10		10		SU204M-C10
	13		SU202M-C13		13		SU204M-C13
	15		SU202M-C15		15		SU204M-C15
	16		SU202M-C16		16		SU204M-C16
	20		SU202M-C20		20		SU204M-C20
	25		SU202M-C25		25		SU204M-C25
	30		SU202M-C30		30		SU204M-C30
	32		SU202M-C32		32		SU204M-C32
35		SU202M-C35	35		SU204M-C35		
40		SU202M-C40	40		SU204M-C40		
50		SU202M-C50	50		SU204M-C50		
60		SU202M-C60	60		SU204M-C60		
63		SU202M-C63	63		SU204M-C63		

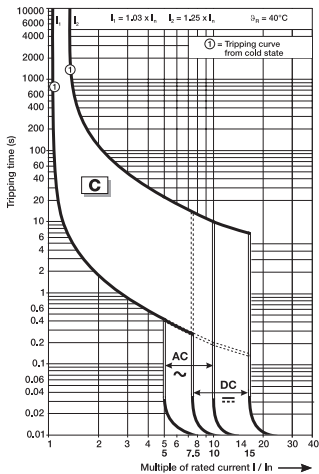

# SU200M-K

## Branch circuit protection—UL 489, CSA 22.2 No. 5

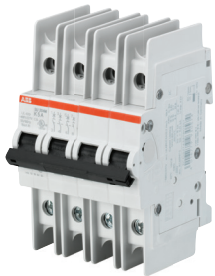

Number of poles	Rated current		Number of poles	Rated current	
	$I_n$ A	Catalog number		$I_n$ A	Catalog number
1	0.2	SU201M-K0.2	3	0.2	SU203M-K0.2
	0.3	SU201M-K0.3		0.3	SU203M-K0.3
	0.5	SU201M-K0.5		0.5	SU203M-K0.5
	0.75	SU201M-K0.75		0.75	SU203M-K0.75
	1	SU201M-K1		1	SU203M-K1
	1.6	SU201M-K1.6		1.6	SU203M-K1.6
	2	SU201M-K2		2	SU203M-K2
	3	SU201M-K3		3	SU203M-K3
	4	SU201M-K4		4	SU203M-K4
	5	SU201M-K5		5	SU203M-K5
	6	SU201M-K6		6	SU203M-K6
	7	SU201M-K7		7	SU203M-K7
	8	SU201M-K8		8	SU203M-K8
	10	SU201M-K10		10	SU203M-K10
	13	SU201M-K13		13	SU203M-K13
	15	SU201M-K15		15	SU203M-K15
	16	SU201M-K16		16	SU203M-K16
	20	SU201M-K20		20	SU203M-K20
	25	SU201M-K25		25	SU203M-K25
30	SU201M-K30	30	SU203M-K30		
32	SU201M-K32	32	SU203M-K32		
35	SU201M-K35	35	SU203M-K35		
40	SU201M-K40	40	SU203M-K40		
50	SU201M-K50	50	SU203M-K50		
60	SU201M-K60	60	SU203M-K60		
63	SU201M-K63	63	SU203M-K63		
2	0.2	SU202M-K0.2	4	0.2	SU204M-K0.2
	0.3	SU202M-K0.3		0.3	SU204M-K0.3
	0.5	SU202M-K0.5		0.5	SU204M-K0.5
	0.75	SU202M-K0.75		0.75	SU204M-K0.75
	1	SU202M-K1		1	SU204M-K1
	1.6	SU202M-K1.6		1.6	SU204M-K1.6
	2	SU202M-K2		2	SU204M-K2
	3	SU202M-K3		3	SU204M-K3
	4	SU202M-K4		4	SU204M-K4
	5	SU202M-K5		5	SU204M-K5
	6	SU202M-K6		6	SU204M-K6
	7	SU202M-K7		7	SU204M-K7
	8	SU202M-K8		8	SU204M-K8
	10	SU202M-K10		10	SU204M-K10
	13	SU202M-K13		13	SU204M-K13
	15	SU202M-K15		15	SU204M-K15
	16	SU202M-K16		16	SU204M-K16
	20	SU202M-K20		20	SU204M-K20
	25	SU202M-K25		25	SU204M-K25
30	SU202M-K30	30	SU204M-K30		
32	SU202M-K32	32	SU204M-K32		
35	SU202M-K35	35	SU204M-K35		
40	SU202M-K40	40	SU204M-K40		
50	SU202M-K50	50	SU204M-K50		
60	SU202M-K60	60	SU204M-K60		
63	SU202M-K63	63	SU204M-K63		

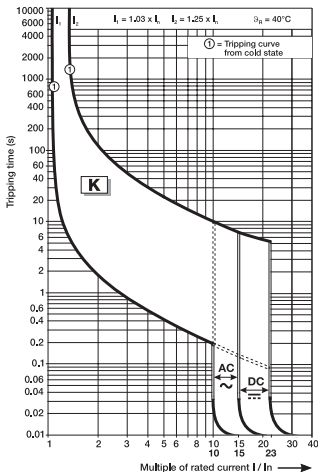

# SU200M-Z

## Branch circuit protection—UL 489, CSA 22.2 No. 5



Number of poles	Rated current		Number of poles	Rated current	
	$I_n$ A	Catalog number		$I_n$ A	Catalog number
1	0.5	SU201M-Z0.5	3	0.5	SU203M-Z0.5
	1	SU201M-Z1		1	SU203M-Z1
	1.6	SU201M-Z1.6		1.6	SU203M-Z1.6
	2	SU201M-Z2		2	SU203M-Z2
	3	SU201M-Z3		3	SU203M-Z3
	4	SU201M-Z4		4	SU203M-Z4
	5	SU201M-Z5		5	SU203M-Z5
	6	SU201M-Z6		6	SU203M-Z6
	7	SU201M-Z7		7	SU203M-Z7
	8	SU201M-Z8		8	SU203M-Z8
	10	SU201M-Z10		10	SU203M-Z10
	13	SU201M-Z13		13	SU203M-Z13
	15	SU201M-Z15		15	SU203M-Z15
	16	SU201M-Z16		16	SU203M-Z16
	20	SU201M-Z20		20	SU203M-Z20
	25	SU201M-Z25		25	SU203M-Z25
	30	SU201M-Z30		30	SU203M-Z30
	32	SU201M-Z32		32	SU203M-Z32
	35	SU201M-Z35		35	SU203M-Z35
40	SU201M-Z40	40	SU203M-Z40		
50	SU201M-Z50	50	SU203M-Z50		
60	SU201M-Z60	60	SU203M-Z60		
63	SU201M-Z63	63	SU203M-Z63		
2	0.5	SU202M-Z0.5	4	0.5	SU204M-Z0.5
	1	SU202M-Z1		1	SU204M-Z1
	1.6	SU202M-Z1.6		1.6	SU204M-Z1.6
	2	SU202M-Z2		2	SU204M-Z2
	3	SU202M-Z3		3	SU204M-Z3
	4	SU202M-Z4		4	SU204M-Z4
	5	SU202M-Z5		5	SU204M-Z5
	6	SU202M-Z6		6	SU204M-Z6
	7	SU202M-Z7		7	SU204M-Z7
	8	SU202M-Z8		8	SU204M-Z8
	10	SU202M-Z10		10	SU204M-Z10
	13	SU202M-Z13		13	SU204M-Z13
	15	SU202M-Z15		15	SU204M-Z15
	16	SU202M-Z16		16	SU204M-Z16
	20	SU202M-Z20		20	SU204M-Z20
	25	SU202M-Z25		25	SU204M-Z25
	30	SU202M-Z30		30	SU204M-Z30
	32	SU202M-Z32		32	SU204M-Z32
	35	SU202M-Z35		35	SU204M-Z35
40	SU202M-Z40	40	SU204M-Z40		
50	SU202M-Z50	50	SU204M-Z50		
60	SU202M-Z60	60	SU204M-Z60		
63	SU202M-Z63	63	SU204M-Z63		

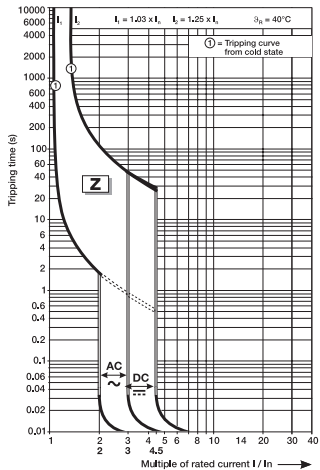

# SU200MR-K with ring tongue terminals

## Branch circuit protection—UL 489, CSA 22.2 No. 5

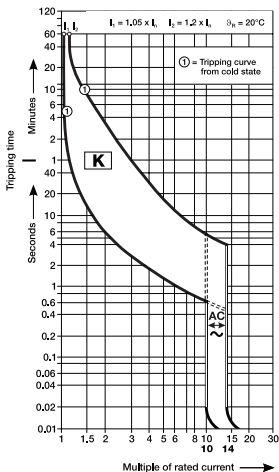

Number of poles	Rated current		Number of poles	Rated current	
	$I_n$ A	Catalog number		$I_n$ A	Catalog number
1	0.2	SU201MR-K0.2	3	0.2	SU203MR-K0.2
	0.3	SU201MR-K0.3		0.3	SU203MR-K0.3
	0.5	SU201MR-K0.5		0.5	SU203MR-K0.5
	0.75	SU201MR-K0.75		0.75	SU203MR-K0.75
	1	SU201MR-K1		1	SU203MR-K1
	1.6	SU201MR-K1.6		1.6	SU203MR-K1.6
	2	SU201MR-K2		2	SU203MR-K2
	3	SU201MR-K3		3	SU203MR-K3
	4	SU201MR-K4		4	SU203MR-K4
	5	SU201MR-K5		5	SU203MR-K5
	6	SU201MR-K6		6	SU203MR-K6
	8	SU201MR-K8		8	SU203MR-K8
	10	SU201MR-K10		10	SU203MR-K10
	13	SU201MR-K13		13	SU203MR-K13
	15	SU201MR-K15		15	SU203MR-K15
	16	SU201MR-K16		16	SU203MR-K16
	20	SU201MR-K20		20	SU203MR-K20
25	SU201MR-K25	25	SU203MR-K25		
30	SU201MR-K30	30	SU203MR-K30		
32	SU201MR-K32	32	SU203MR-K32		
35	SU201MR-K35	35	SU203MR-K35		
40	SU201MR-K40	40	SU203MR-K40		
50	SU201MR-K50	50	SU203MR-K50		
60	SU201MR-K60	60	SU203MR-K60		
63	SU201MR-K63	63	SU203MR-K63		
2	0.2	SU202MR-K0.2	4	0.2	SU204MR-K0.2
	0.3	SU202MR-K0.3		0.3	SU204MR-K0.3
	0.5	SU202MR-K0.5		0.5	SU204MR-K0.5
	0.75	SU202MR-K0.75		0.75	SU204MR-K0.75
	1	SU202MR-K1		1	SU204MR-K1
	1.6	SU202MR-K1.6		1.6	SU204MR-K1.6
	2	SU202MR-K2		2	SU204MR-K2
	3	SU202MR-K3		3	SU204MR-K3
	4	SU202MR-K4		4	SU204MR-K4
	5	SU202MR-K5		5	SU204MR-K5
	6	SU202MR-K6		6	SU204MR-K6
	8	SU202MR-K8		8	SU204MR-K8
	10	SU202MR-K10		10	SU204MR-K10
	13	SU202MR-K13		13	SU204MR-K13
	15	SU202MR-K15		15	SU204MR-K15
	16	SU202MR-K16		16	SU204MR-K16
	20	SU202MR-K20		20	SU204MR-K20
25	SU202MR-K25	25	SU204MR-K25		
30	SU202MR-K30	30	SU204MR-K30		
32	SU202MR-K32	32	SU204MR-K32		
35	SU202MR-K35	35	SU204MR-K35		
40	SU202MR-K40	40	SU204MR-K40		
50	SU202MR-K50	50	SU204MR-K50		
60	SU202MR-K60	60	SU204MR-K60		
63	SU202MR-K63	63	SU204MR-K63		

# S200UDC-K

## Branch circuit protection—UL 489, CSA 22.2 No. 5



Number of poles	Rated current	
	$I_n$ A	Catalog number
1	1	S201UDC-K1
	1.6	S201UDC-K1.6
	2	S201UDC-K2
	3	S201UDC-K3
	4	S201UDC-K4
	5	S201UDC-K5
	6	S201UDC-K6
	8	S201UDC-K8
	10	S201UDC-K10
	13	S201UDC-K13
	15	S201UDC-K15
	16	S201UDC-K16
	20	S201UDC-K20
	25	S201UDC-K25
	30	S201UDC-K30
	32	S201UDC-K32
	40	S201UDC-K40
	50	S201UDC-K50
	60	S201UDC-K60
63	S201UDC-K63	
2	1	S202UDC-K1
	1.6	S202UDC-K1.6
	2	S202UDC-K2
	3	S202UDC-K3
	4	S202UDC-K4
	5	S202UDC-K5
	6	S202UDC-K6
	8	S202UDC-K8
	10	S202UDC-K10
	13	S202UDC-K13
	15	S202UDC-K15
	16	S202UDC-K16
	20	S202UDC-K20
	25	S202UDC-K25
	30	S202UDC-K30
	32	S202UDC-K32
	40	S202UDC-K40
	50	S202UDC-K50
	60	S202UDC-K60
63	S202UDC-K63	

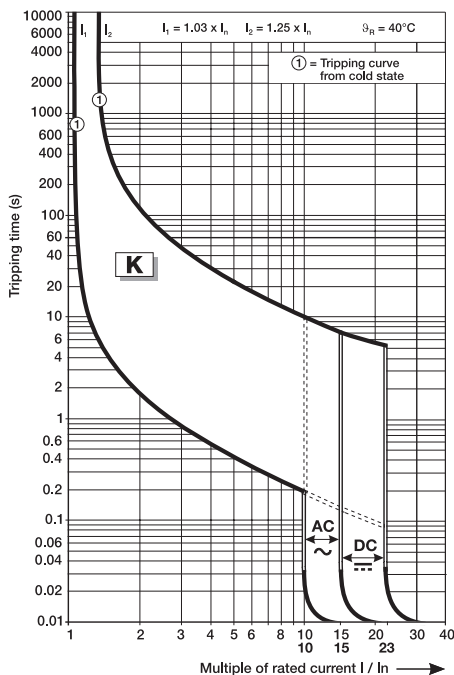

Note: Standard UL 489 (only DC; please note polarity of device).



# S200UDC-Z

## Branch circuit protection—UL 489, CSA 22.2 No. 5



Number of poles	Rated current	
	$I_n$ A	Catalog number
1	1	S201UDC-Z1
	1.6	S201UDC-Z1.6
	2	S201UDC-Z2
	3	S201UDC-Z3
	4	S201UDC-Z4
	5	S201UDC-Z5
	6	S201UDC-Z6
	8	S201UDC-Z8
	10	S201UDC-Z10
	13	S201UDC-Z13
	15	S201UDC-Z15
	16	S201UDC-Z16
	20	S201UDC-Z20
	25	S201UDC-Z25
	30	S201UDC-Z30
	32	S201UDC-Z32
40	S201UDC-Z40	
50	S201UDC-Z50	
60	S201UDC-Z60	
63	S201UDC-Z63	
2	1	S202UDC-Z1
	1.6	S202UDC-Z1.6
	2	S202UDC-Z2
	3	S202UDC-Z3
	4	S202UDC-Z4
	5	S202UDC-Z5
	6	S202UDC-Z6
	8	S202UDC-Z8
	10	S202UDC-Z10
	13	S202UDC-Z13
	15	S202UDC-Z15
	16	S202UDC-Z16
	20	S202UDC-Z20
	25	S202UDC-Z25
	30	S202UDC-Z30
	32	S202UDC-Z32
40	S202UDC-Z40	
50	S202UDC-Z50	
60	S202UDC-Z60	
63	S202UDC-Z63	

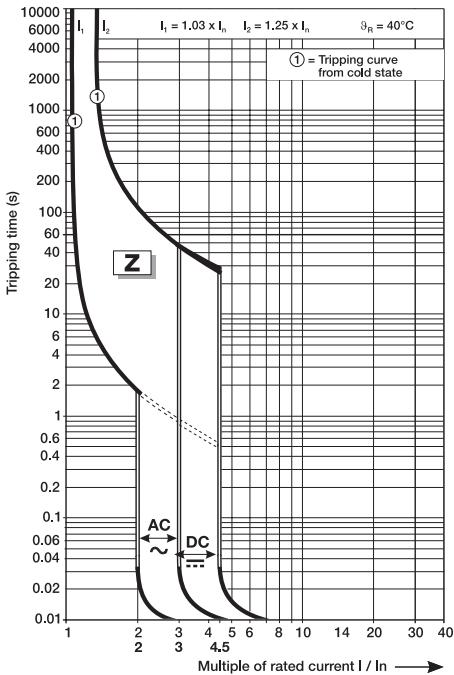

Note: Standard UL 489 (only DC; please note polarity of device).

# Accessories

## SU200M, SU200MR, and S200UDC—UL 489, CSA 22.2 No. 5



S2C-H6RU

### Auxiliary contacts

The auxiliary contacts will signal whether the breaker is in the ON or OFF position.

Description	Catalog number
For field mounting: right side	S2C-H6RU



S2C-S6RU

### Bell alarm

The bell alarm includes a set of contacts that will only signal when the breaker has tripped. Typically, the contacts would be connected to an alarm or bell to signal the operator that an overcurrent trip has occurred. The bell alarm also includes a test button for testing the alarm contacts without opening the breaker.

Description	Catalog number
For field mounting: right side	S2C-S6RU



S2C-A...U

### Shunt trip

For remote tripping of breaker, a shunt trip device can be added to the MCB. The solenoid device opens the breaker after control voltage is applied.

Description	Catalog number
For field mounting: right side 12...60 VAC/DC	S2C-A1U
For field mounting: right side 110...415 VAC	S2C-A2U
110...250 VDC	

Note: For shafts and handles, refer to parts in the Disconnect Switch and MCCB section.

### Accessory overview

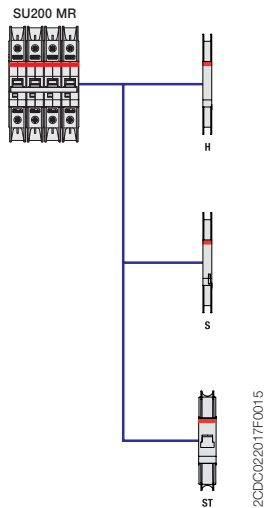

- H Auxiliary contact S2C-H6RU
- S Signal contact S2C-S6RU
- ST Shunt trip S2C-A...U

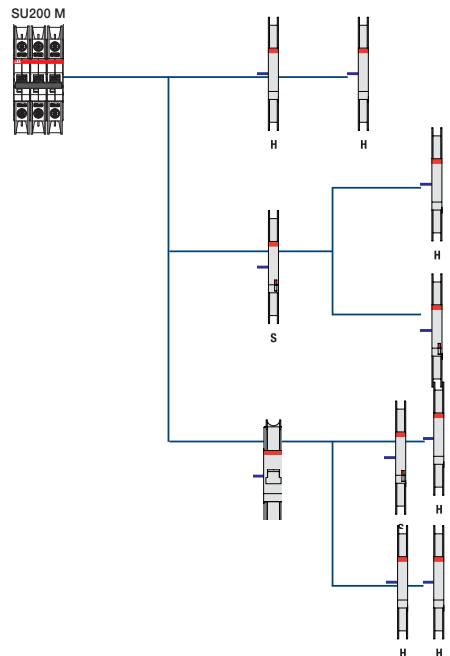

- H Auxiliary contact S2C-H6RU (change-over contact)
- S/H Signal contact S2C-S6RU
- ST Shunt trip S2C-A...U

# Accessories

## SU200M, SU200MR, and S200UDC—UL 489, CSA 22.2 No. 5



S2C-DH

2CSC400064F0201

### Rotary operating mechanism

For the actuation of 2-, 3- or 4pole miniature circuit-breakers in closed distribution boards for driveaxles of 5 or 6 mm<sup>2</sup> (square)

	Catalog number
	S2C-DH

### Handles

Handle IP 65, 65 x 65 mm, padlockable with max. 3 padlocks (bail diameter 5 - 8 mm), door interlock in ON-position, adjustable\*

Color	Suitable for switches	Catalog number
Black	OT16...40F	OHBS2AJ
Yellow-red	OT16...40F	OHYS2AJ
Silver	OT16...40F	OHSS2AJ
Grey	OT16...40F	OHGS2AJ



OH

S00396A

Handle IP 65, 65 x 65 mm, padlockable with max. 3 padlocks (bail diameter 5 - 8 mm), door interlock in ON-position

Color	Suitable for switches	Catalog number
Black	OT16...40F	OHBS2AJ1
Yellow-red	OT16...40F	OHYS2AJ1
Silver	OT16...40F	OHSS2AJ1
Grey	OT16...40F	OHGS2AJ1

\* OH\_2\_J enables selection of MCB behavior when opening panel door (remain switched on or switch off). OH\_2\_J1 will cause MCB to switch off when opening panel door.

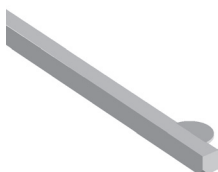

OXS6X

S01026A

### Axle extension

Type and order numbers are for one piece. For selector type handles. Shaft diameter 6 mm.

Length	Suitable for switches	Catalog number
85	OT16...40F	OXS6X85
105	OT16...40F	OXS6X105
120	OT16...40F	OXS6X120
130	OT16...40F	OXS6X130
160	OT16...40F	OXS6X160
180	OT16...40F	OXS6X180
250	OT16...40F	OXS6X250
330	OT16...40F	OXS6X330

# Accessories

## SU200M, SU200MR, and S200UDC—UL 489, CSA 22.2 No. 5

### Connection drawings

#### Bell alarm S2C-S6RU

In ON and OFF position after hand operation

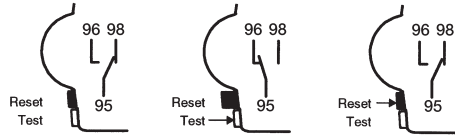

#### Auxiliary contact S2C-H6RU

Auxiliary contact in ON position



#### Shunt trip S2C-A...U



In OFF position after tripping

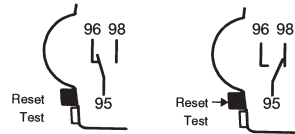

Auxiliary contact in OFF position



### Mounting

#### Addition of a S2C-H6RU auxiliary contact

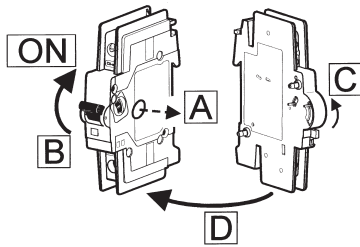

#### Addition of a S2C-S6RU bell alarm contact

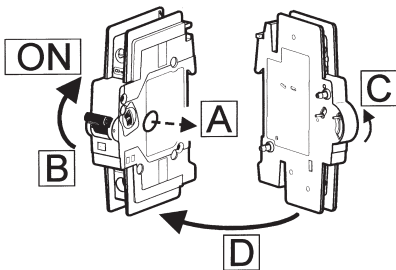

#### Addition of a S2C-A...U shunt trip

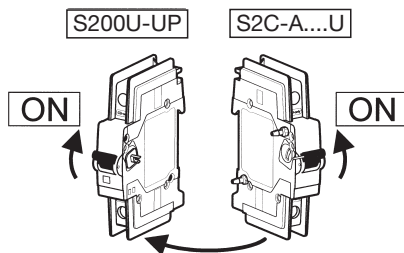

# Accessories

## SU200MR—UL 489, CSA 22.2 No. 5

### SU200MR Instructions for use

**Ring Tongue Terminal, Special purpose - Not for general use**

**Installation Instructions**

Please insert or withdraw the cable lug only when the screw is completely open.



Please make sure that the terminal screw penetrates the ring lug hole properly and completely during tightening.



Please ensure that the screw is securely tightened before applying any mechanical force on the cable / cable lug.

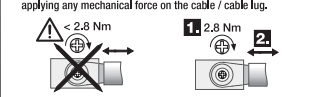



Do not apply abnormal downward pressure on the screw during tightening or loosening of the screw.



F= max. 30 N      F= Maximum to operate

Please follow the Ring Tongue Details on the rear of this sheet.

**Ring Tongue Details**

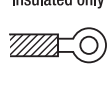
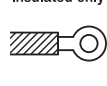
Only	Insulated only	A	B	C
 or  ring cable lugs	 Rated voltage 480Y/277 V AC	max. 11.0 mm (0.43")	max. 12.2 mm (0.48")	Suitable for M5 (0.20")
	 Rated voltage 240/240 V AC	max. 14.0 mm (0.55")	max. 12.2 mm (0.48")	Suitable for M5 (0.20")

CU only  
 60/75°C  
 (140/167°F)

max. 2.0 mm  
 (0.08")

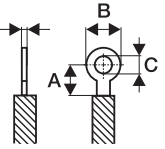

PZ 2 Torque: 2.8 Nm (25lb-in)



# Accessories

## SU200M, SU200MR, and S200UDC—UL 489, CSA 22.2 No. 5



PS2/6/16 BP

### Busbars for SU200M

Busbars cannot be cut. 600 V AC/DC

Amp rating*	Number of poles	Phases	Busbar length (mm)	Catalog number
80/115	6	1	103.2	PS 1/6/16BP
	12	1	208.8	PS 1/12/16BP
	18	1	314.4	PS 1/18/16BP
80/115	6	2	103.2	PS 2/6/16BP
	12	2	208.8	PS 2/12/16BP
	18	2	314.4	PS 2/18/16BP
80/115	6	3	103.2	PS 3/6/16BP
	12	3	208.8	PS 3/12/16BP
	18	3	314.4	PS 3/18/16BP

\*End/centerfed

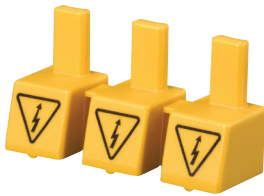

BSK-BP

### Busbar tooth covers for BS...BP (UL 489)

Description	Catalog number
Covers three unused poles of busbar	BSK-BP



AST35/15BP

SZ-ESPBP

### Feeder terminals for PS...BP (UL 489)

Description	Catalog number
Terminal, insulated with pin contact	AST35/15BP
Feeder terminal, single-pole terminal, can be mounted side by side, feed on the pin of the busbar	SZ-ESK BP

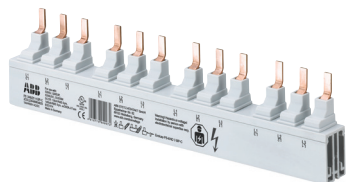

PS...BP-C

### Busbars PS...BP-C for use with end caps PS-END 3 BP-C

Number of phases	Phase sequence	Catalog number
1	L1-L1-L1...	PS1/57/25BP-C
	L1-Aux (free)-L1-Aux (free)...1	PS1/37/25HBP-C
2	L1-L2-L1-L2...	PS2/56/25BP-C
	L1-L2-Aux (free)-L1-L2-Aux (free)...1	PS2/46/25HBP-C
3	L1-L2-L3-L1-L2-L3...	PS3/57/25BP-C
	L1-L2-L3-Aux (free)-L1-L2-L3-Aux (free)...1	PS3/48/25HBP-C
	L1-Aux (free)-L2-Aux (free)-L3-Aux (free)...1	PS3/39/25HBP-C

<sup>1)</sup> for devices with auxiliary contact (half module) after each phase sequence

### Accessories

Description	Catalog number
Tooth covers, for 3 pins	BSK BP-C
End caps	PS-END 3 BP-C
Feeder terminal	AST 35/58 BP-C

# Accessories

## SU200M, SU200MR, and S200UDC—UL 489, CSA 22.2 No. 5

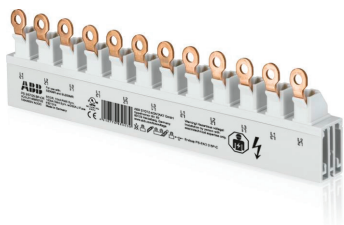

PS...BP-CR

### Busbars for SU200MR, can be cut to length

Busbars PS...BP-CR for use with end caps PS-END 3 BP-C

Number of phases	Phase sequence	Number of pins pcs.	Cross section mm <sup>2</sup>	Catalog number
1	L1-L1-L1...	57	25	PS1/57/25BP-CR
	L1-Aux (free)-L1-Aux (free)...1)	37	25	PS1/37/25HBP-CR
2	L1-L2-L1-L2...	56	25	PS2/56/25BP-CR
	L1-L2-Aux (free)-L1-L2-Aux (free)...1)	46	25	PS2/46/25HBP-CR
3	L1-L2-L3-L1-L2-L3...	57	25	PS3/57/25BP-CR
	L1-L2-L3-Aux (free)-L1-L2-L3-Aux (free)...1)	48	25	PS3/48/25HBP-CR
	L1-Aux (free)-L2-Aux (free)-L3-Aux (free)...1)	39	25	PS3/39/25HBP-CR

<sup>1)</sup> for devices with auxiliary contact (half module) after each phase sequence

### Accessories

Description	Catalog number
Tooth covers, for 3 pins	BSK BP-CR
End caps	PS-END 3 BP-C



### Lockout/Tag out device

Product description	Catalog number
For Single-pole MCBs	S2C-LOTO-S
For Multi-pole MCBs	S2C-LOTO-M

# Technical specifications

## SU200M, SU200MR, and S200UDC – UL 489, CSA 22.2 No. 5

### Technical specifications

	SU200M	SU200MR	S200UDC
<b>Specifications</b>	UL 489, C 22.2 No. 5, IEC 60947-2	UL 489, C 22.2 No. 5, IEC 60947-2	UL 489, VDE 0660
<b>UL file number</b>	E 212323, UL current limiting	E 212323, UL current limiting	E212323
<b>Number of poles</b>	1, 2, 3, 4	1, 2, 3, 4	1, 2
<b>Trip curves</b>	C, K, Z	K	Z, K
<b>Rated current</b>	Up to 63 A	Up to 63 A	Up to 63 A
<b>Rated voltage</b>	277/Y480 VAC up to 40 A (Z and C trip curves) 277/Y480 VAC up to 35 A (K trip curve) 240 VAC up to 63 A (all trip curves) 48/96 VDC up to 63 A (1/2-pole, all trip curves)	277/Y480 VAC (up to 35 A) 240 VAC up to 63 A	60/125 VDC (1/2-pole)
<b>Short circuit interrupt rating</b>	10 kA	10 kA	14 kA
<b>Calibration temperature</b>	40 °C	40 °C	25 °C
<b>Mounting position</b>	Any	Any	Any
<b>Protection degree</b>	IP 20	IP 20	IP 20 with accessory
<b>Mounting</b>	35 mm DIN rail	35 mm DIN rail	35 mm DIN rail
<b>Terminal screw tightening torque</b>	25 in. lbs (2.8 Nm)	25 in. lbs (2.8 Nm)	25 in. lbs (2.8 Nm)
<b>Cable size</b>	AWG 4-16	AWG 4-16	AWG 4-16
<b>Ambient temperature</b>	-25 °C...+55 °C/-13 °F...+131 °F	-25 °C...+55 °C/-13 °F...+131 °F	-25 °C...+55 °C/-13 °F...+131 °F
<b>Shock resistance (IEC60068-2-27)</b>	25 g - 2 shocks - 13 ms	25 g - 2 shocks - 13 ms	25 g - 2 shocks - 13 ms
<b>Service life, mechanical</b>	20,000 operations	20,000 operations	20,000 operations

### Auxiliary contact S2C-H6RU and S2C-S6RU

<b>Rated current</b>	10
<b>Rated voltage AC/DC</b>	24
<b>Contact</b>	1 pole double throw
<b>Connection capacity mm<sup>2</sup></b>	18-14 AWG (0.75...2.5 mm <sup>2</sup> )
<b>Tightening torque</b>	11 in. lbs (1.2 Nm)
<b>Shock resistance acc. to DIN IEC 68-2-6</b>	5 g, 20 frequency cycles 5...150...5 Hz at 24 VAC/DC, 5 mA auto-reclosing < 10 ms
<b>Mechanical service life</b>	10,000 operations

### Shunt trip

			S2C-A1U	S2C-A2U
<b>Rated voltage</b>	AC	V	12...60	110...415
	DC	V	12...60	110...250
<b>Maximum release duration</b>		ms	<10	<10
<b>Minimum release voltage</b>	AC	V	7	55
	DC	V	10	80
<b>Consumption on release</b>	AC	VA	40...200	55...210
	DC	VA	40...200	55...110
<b>Coil resistance</b>		Ω	3.7	225
<b>Terminals</b>		AWG/mm <sup>2</sup>	18...6/0.75-16	18...6/0.75-16
<b>Tightening torque</b>		in. lbs./Nm	18/2	18/2

# Technical specifications

## SU200M, SU200MR, and S200UDC—UL 489, CSA 22.2 No. 5

### Internal resistance and power loss per pole

Internal resistance per pole in  $m\Omega$ , power loss per pole in W.

#### SU200M

Rated current $I_n$ A	C, K characteristics		Z characteristics	
	Internal resistance per pole $R_i$ $m\Omega$	Power loss $P_v$ W	Internal resistance per pole $R_i$ $m\Omega$	Power loss $P_v$ W
0.2	42500	1.7	-	-
0.3	18889	1.7	-	-
0.5	5600	1.4	9000	2.3
0.75	2489	1.4	-	-
1	1400	1.4	2200	2.2
1.6	703	1.8	1000	2.6
2	450	1.8	650	2.6
3	178	1.6	250	2.3
4	113	1.8	140	2.2
5	50	1.3	100	2.5
6	56	2.0	70	2.5
8	23	1.5	28	1.8
10	21	2.1	21	2.1
13	14	2.3	17	2.9
15	11	2.4	13	2.9
16	9.8	2.5	10	2.6
20	6.3	2.5	6.5	2.6
25	5.1	3.2	5.1	3.2
30	3.9	3.5	3.9	3.5
32	3.6	3.7	3.6	3.7
35	3.3	4.1	3.3	4.1
40	2.8	4.5	2.8	4.5
50	1.8	4.5	1.8	4.5
60	1.4	4.9	1.4	4.9
63	1.4	5.4	1.4	5.4

Internal resistances are subject to application-specific and environment-specific conditions and are therefore to be considered as typical values.

#### SU200MR

Rated current A	Internal resistance per pole <sup>1)</sup> $m\Omega$	Power loss per pole <sup>1)</sup> W
0.2	25300	1.01
0.3	13700	1.23
0.5	4740	1.19
0.75	2067	1.16
1	1270	1.27
1.5	610	1.56
2	442	1.77
3	140	1.26
4	109	1.75
5	50	1.26
6	54	1.94
8	22	1.41
10	18.2	1.82
13	14.8	2.50
15	8.1	1.83
16	11.1	2.83
20	8.5	3.40
25	5.5	3.43
30	3.8	3.39
32	4.6	4.70
35	3.9	4.76
40	2.8	4.40
50	1.7	4.25
60	1.7	6.18
63	1.9	7.56

<sup>1)</sup>Internal resistances and power loss are subject to application-specific and environment-specific conditions and are therefore to be considered as typical values.

# Technical specifications

## SU200M, SU200MR, and S200UDC—UL 489, CSA 22.2 No. 5

### Temperature derating SU200M and SU200MR

Standard	Rated current $I_n$ A	Maximum operating current at ambient temperature T											
		- 40 °C	- 30 °C	- 20 °C	- 10 °C	0 °C	10 °C	20 °C	30 °C	40 °C	50 °C	60 °C	70 °C
UL 489	0.2 <sup>1)</sup>	0.27	0.26	0.25	0.24	0.23	0.22	0.22	0.21	0.20	0.19	0.19	0.18
	0.3 <sup>1)</sup>	0.40	0.39	0.37	0.36	0.35	0.33	0.32	0.31	0.30	0.29	0.28	0.27
	0.5	0.67	0.64	0.62	0.60	0.58	0.56	0.54	0.52	0.5	0.48	0.46	0.45
	0.75 <sup>1)</sup>	1.00	0.97	0.93	0.90	0.87	0.84	0.81	0.78	0.75	0.72	0.70	0.67
	1	1.34	1.29	1.24	1.20	1.16	1.12	1.08	1.04	1	0.96	0.93	0.89
	1.6	1.74	1.68	1.62	1.56	1.50	1.45	1.40	1.35	1.3	1.25	1.21	1.16
	2	2.67	2.58	2.49	2.40	2.31	2.23	2.15	2.07	2	1.93	1.85	1.79
	3	4.01	3.87	3.73	3.60	3.47	3.35	3.23	3.11	3	2.89	2.78	2.68
	4	5.35	5.16	4.97	4.80	4.63	4.46	4.30	4.15	4	3.85	3.71	3.57
	5	6.69	6.45	6.22	6.00	5.78	5.58	5.38	5.19	5	4.82	4.64	4.47
	6	8.02	7.74	7.46	7.20	6.94	6.69	6.45	6.22	6	5.78	5.56	5.36
	8	10.70	10.32	9.95	9.59	9.25	8.92	8.60	8.30	8	7.70	7.42	7.14
	10	13.37	12.90	12.44	11.99	11.56	11.15	10.75	10.37	10	9.63	9.27	8.93
	13	17.38	16.76	16.17	15.59	15.03	14.50	13.98	13.48	13	12.52	12.06	11.61
	15	20.06	19.34	18.65	17.99	17.35	16.73	16.13	15.56	15	14.45	13.91	13.40
	16	21.40	20.63	19.90	19.19	18.50	17.84	17.21	16.59	16	15.41	14.84	14.29
	20	26.75	25.79	24.87	23.98	23.13	22.30	21.51	20.74	20	19.26	18.55	17.86
	25	33.43	32.24	31.09	29.98	28.91	27.88	26.88	25.93	25	24.08	23.18	22.33
	30	40.12	38.69	37.31	35.98	34.69	33.45	32.26	31.11	30	28.89	27.82	26.79
	32	42.79	41.27	39.79	38.37	37.01	35.69	34.41	33.18	32	30.82	29.68	28.58
35	46.81	45.14	43.53	41.97	40.47	39.03	37.64	36.30	35	33.71	32.46	31.26	
40	53.49	51.58	49.74	47.97	46.26	44.61	43.01	41.48	40	38.52	37.09	35.72	
50	66.87	64.48	62.18	59.96	57.82	55.76	53.77	51.85	50	48.15	46.37	44.65	
60	80.24	77.38	74.61	71.95	69.39	66.91	64.52	62.22	60	57.78	55.64	53.58	
63	84.25	81.24	78.35	75.55	72.85	70.25	67.75	65.33	63	60.67	58.42	56.26	

<sup>1)</sup> Current ratings 0.2, 0.3 and 0.75 A available with K characteristic only.



# Technical specifications

## Busbars PS...BP-C/CR and accessories

Electrical data		Busbars PS...BP-C/CR
Standards		UL508 EN 60947-1 / IEC 60947-1:2004
Rated voltage U <sub>n</sub>	V	600 V AC/DC
Rated frequency	Hz	50 Hz (IEC) / 60 Hz (UL)
Rated impuls withstand voltage U <sub>imp</sub>	kV	≥ 10 kV
Rated current / phase		
End fed <sup>1)</sup>	A	100 A
Center fed <sup>1)</sup>	A	200 A
Short circuit current rating	kA	10 kA 3 cycles @ 600 V / 140 kA Fuse Class J 200 A
Mechanical data		
Housing		grey, RAL 7035
Resistance to climatic conditions		acc. to DIN EN 60068
Isolation coordination		
Overtoltage category		III
Pollution degree		2
Installation		
Cross section	mm <sup>2</sup>	25 mm <sup>2</sup>
Mounting position		Optional
Supply		Via cable with ring lug (PS...BP-CR); direct or via feeder terminal (PS...BP-C)
Accessories		
Shock protection caps		BSK BP-CR (for PS...BP-CR), BSK BP-C (for PS...BP-C)
Endcaps		PS-END 3 BP-C
Approvals		
		CE, RoHS
		UL 508: cULus Listed

<sup>1)</sup> Independently from the current rating of the feeder terminal or busbar, the current-carrying capacity/current rating of the MCB terminal must not be exceeded.

### Installation/assembly

**Warning:** When busbars are shortened, they must be deburred and cleaned of debris. Touch-safe only when used with the required end caps.

### Dimensional drawing

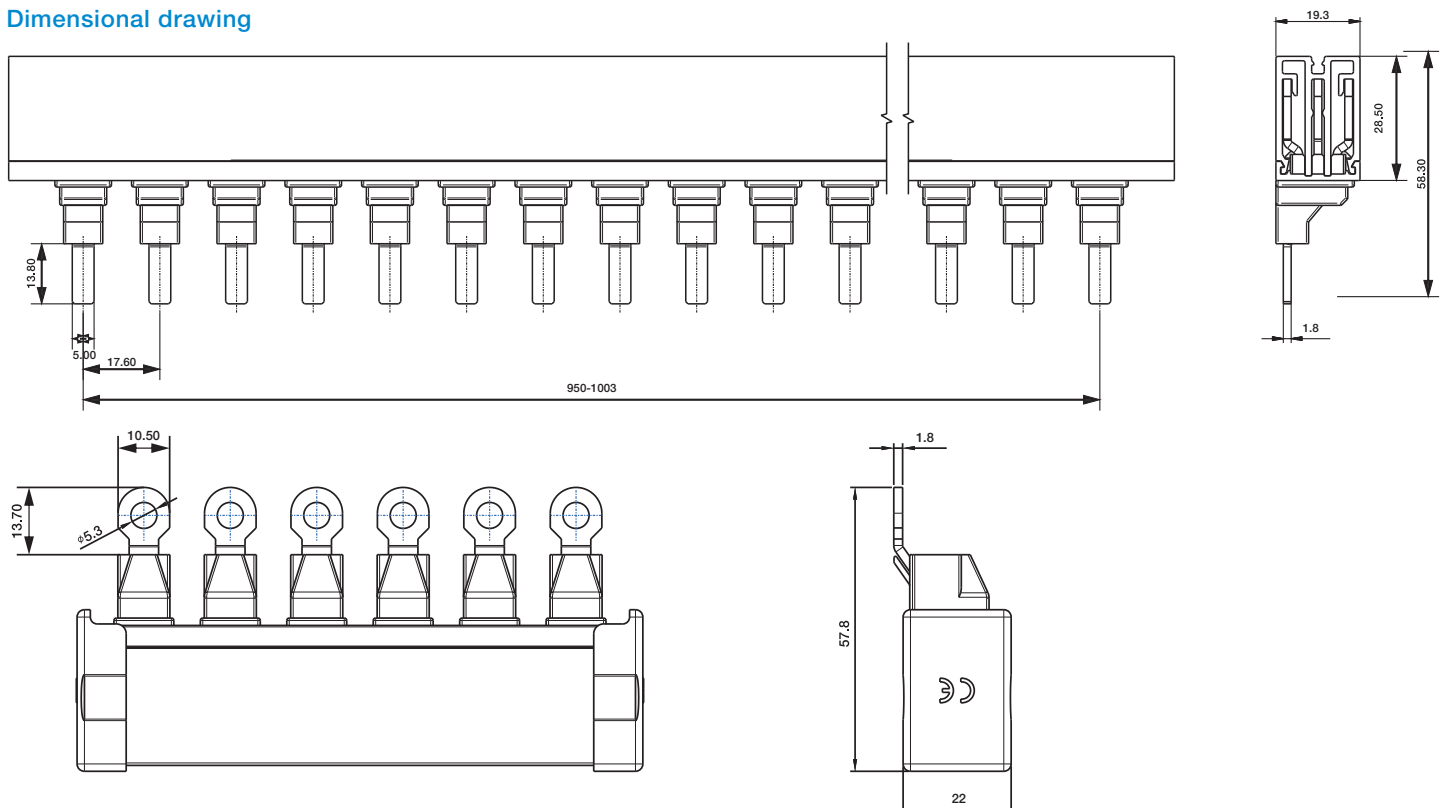

# Approximate dimensions SU200M, SU200MR, and S200UDC—UL 489, CSA 22.2 No. 5

**SU200M**

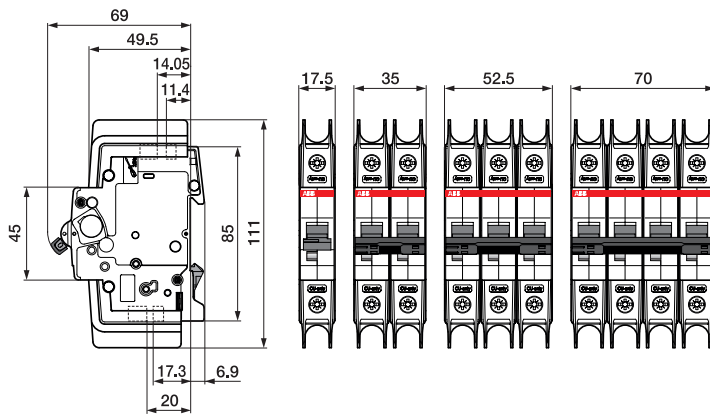

**S200UDC**

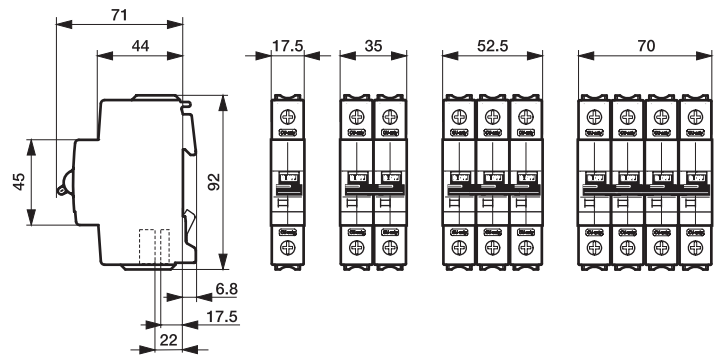

**SU200MR**

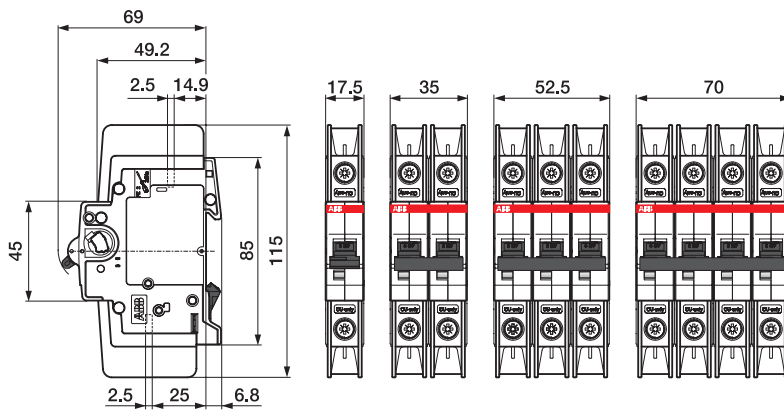

**S2C-H6RU, S2C-S6RU**

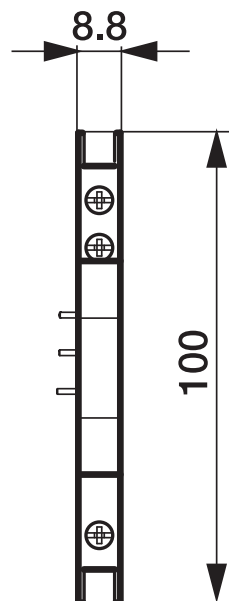

**S2C-A..U**

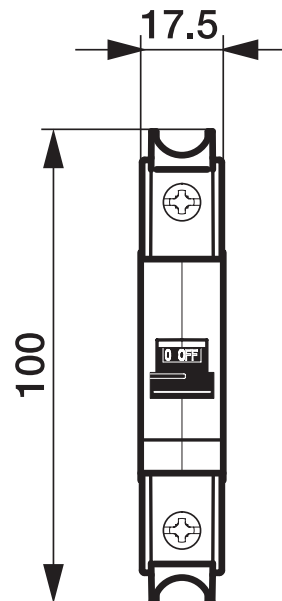

Dimensions in (mm)

# S200 series

## Supplementary protective devices—UL 1077 series



### Description

The S200 UL 1077 family of supplementary protectors offers a compact solution for protection requirements. The S200 devices are DIN rail mounted.

The S200 family is available with application-specific trip characteristics to provide maximum circuit protection.

The supplementary protectors offer thermal magnetic trip protection according to B, C, D, K and Z characteristics.

For the worldwide market, the breakers carry UL, CSA, IEC, CE and many other agency approvals and certifications.

### Features

- Energy limiting
- Fast breaking time (2.3 – 2.5 ms)
- Bus connection system
- Wide range of accessories
- Available with variable depth handle mechanism
- CE certified and marked
- DIN rail mounting
- Finger safe terminals
- Multi-function terminals
- Suitable for reverse feed
- UL 1077 recognized supplemental protective device. UL file #E76126

	S200	S200P	S200MR	S200MUC
<b>Amperage</b>	Up to 63 A	Up to 63 A	Up to 63 A	Up to 63 A
<b>Voltage</b>	277/Y480 VAC 60/110 VDC (1/2-pole)	277/Y480 VAC	277/Y480 VAC	277/Y480 VAC 250/500 VDC (1/2-pole)
<b>Poles</b>	1, 2, 3, 4	1, 2, 3, 4	1, 2, 3, 4	1, 2, 3, 4
<b>Trip curves</b>	B, C, D, K, Z	B, C, D, K, Z	K	C, K, Z
<b>Short circuit interrupt rating</b>	6 kA	10 kA (up to 25 A) 6 kA (32-63 A)	10 kA	10 kA
<b>Auxiliary contacts</b>	Yes	Yes	Yes	Yes
<b>Bell alarm</b>	Yes	Yes	Yes	Yes
<b>Shunt trip</b>	Yes	Yes	Yes	Yes
<b>Undervoltage release</b>	Yes	Yes	Yes	Yes
<b>Busbar</b>	Yes	Yes	Yes	Yes

# S200-B

## Supplemental protectors—UL 1077, CSA 22.2 No. 235



Number of poles	Rated current		Number of poles	Rated current	
	$I_n$ A	Catalog number		$I_n$ A	Catalog number
1	6	S201-B6	3	6	S203-B6
	10	S201-B10		10	S203-B10
	13	S201-B13		13	S203-B13
	16	S201-B16		16	S203-B16
	20	S201-B20		20	S203-B20
	25	S201-B25		25	S203-B25
	32	S201-B32		32	S203-B32
	40	S201-B40		40	S203-B40
1 + NA	50	S201-B50	3 + NA	50	S203-B50
	63	S201-B63		63	S203-B63
	6	S201-B6NA		6	S203-B6NA
	10	S201-B10NA		10	S203-B10NA
	13	S201-B13NA		13	S203-B13NA
	16	S201-B16NA		16	S203-B16NA
	20	S201-B20NA		20	S203-B20NA
	25	S201-B25NA		25	S203-B25NA
2	32	S201-B32NA	4	32	S203-B32NA
	40	S201-B40NA		40	S203-B40NA
	50	S201-B50NA		50	S203-B50NA
	63	S201-B63NA		63	S203-B63NA
	6	S202-B6		6	S204-B6
	10	S202-B10		10	S204-B10
	13	S202-B13		13	S204-B13
	16	S202-B16		16	S204-B16
2	20	S202-B20	4	20	S204-B20
	25	S202-B25		25	S204-B25
	32	S202-B32		32	S204-B32
	40	S202-B40		40	S204-B40
	50	S202-B50		50	S204-B50
	63	S202-B63		63	S204-B63

Note: Switching neutral is noted by "NA" in the catalog number.

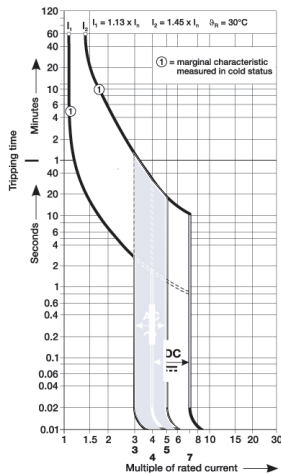

# S200-C

## Supplemental protectors — UL 1077, CSA 22.2 No. 235

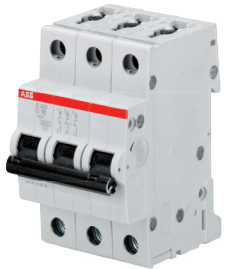

Number of poles	Rated current		Number of poles	Rated current	
	$I_n$ A	Catalog number		$I_n$ A	Catalog number
1	0.5	S201-C0.5	3	0.5	S203-C0.5
	1	S201-C1		1	S203-C1
	1.6	S201-C1.6		1.6	S203-C1.6
	2	S201-C2		2	S203-C2
	3	S201-C3		3	S203-C3
	4	S201-C4		4	S203-C4
	6	S201-C6		6	S203-C6
	8	S201-C8		8	S203-C8
	10	S201-C10		10	S203-C10
	13	S201-C13		13	S203-C13
	16	S201-C16		16	S203-C16
	20	S201-C20		20	S203-C20
	25	S201-C25		25	S203-C25
	32	S201-C32		32	S203-C32
	40	S201-C40		40	S203-C40
	50	S201-C50		50	S203-C50
63	S201-C63	63	S203-C63		
1 + NA	0.5	S201-C0.5NA	3 + NA	0.5	S203-C0.5NA
	1	S201-C1NA		1	S203-C1NA
	1.6	S201-C1.6NA		1.6	S203-C1.6NA
	2	S201-C2NA		2	S203-C2NA
	3	S201-C3NA		3	S203-C3NA
	4	S201-C4NA		4	S203-C4NA
	6	S201-C6NA		6	S203-C6NA
	8	S201-C8NA		8	S203-C8NA
	10	S201-C10NA		10	S203-C10NA
	13	S201-C13NA		13	S203-C13NA
	16	S201-C16NA		16	S203-C16NA
	20	S201-C20NA		20	S203-C20NA
	25	S201-C25NA		25	S203-C25NA
	32	S201-C32NA		32	S203-C32NA
	40	S201-C40NA		40	S203-C40NA
	50	S201-C50NA		50	S203-C50NA
63	S201-C63NA	63	S203-C63NA		
2	0.5	S202-C0.5	4	0.5	S204-C0.5
	1	S202-C1		1	S204-C1
	1.6	S202-C1.6		1.6	S204-C1.6
	2	S202-C2		2	S204-C2
	3	S202-C3		3	S204-C3
	4	S202-C4		4	S204-C4
	6	S202-C6		6	S204-C6
	8	S202-C8		8	S204-C8
	10	S202-C10		10	S204-C10
	13	S202-C13		13	S204-C13
	16	S202-C16		16	S204-C16
	20	S202-C20		20	S204-C20
	25	S202-C25		25	S204-C25
	32	S202-C32		32	S204-C32
	40	S202-C40		40	S204-C40
	50	S202-C50		50	S204-C50
63	S202-C63	63	S204-C63		

Note: Switching neutral is noted by "NA" in the catalog number.

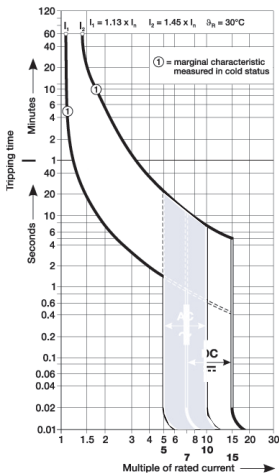



# S200-D

## Supplemental protectors—UL 1077, CSA 22.2 No. 235

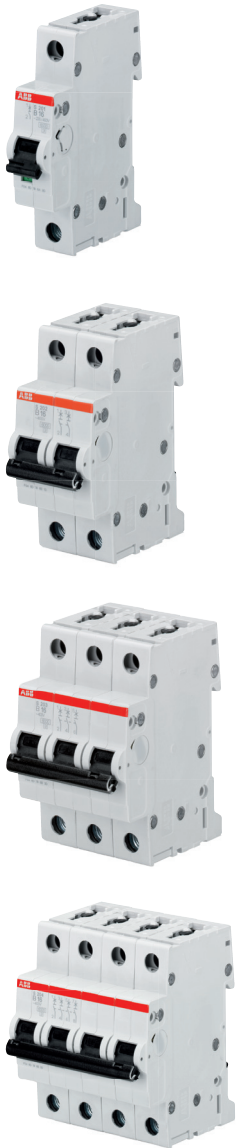

Number of poles	Rated current		Number of poles	Rated current	
	$I_n$ A	Catalog number		$I_n$ A	Catalog number
1	0.5	S201-D0.5	3	0.5	S203-D0.5
	1	S201-D1		1	S203-D1
	1.6	S201-D1.6		1.6	S203-D1.6
	2	S201-D2		2	S203-D2
	3	S201-D3		3	S203-D3
	4	S201-D4		4	S203-D4
	6	S201-D6		6	S203-D6
	8	S201-D8		8	S203-D8
	10	S201-D10		10	S203-D10
	13	S201-D13		13	S203-D13
	16	S201-D16		16	S203-D16
	20	S201-D20		20	S203-D20
	25	S201-D25		25	S203-D25
	32	S201-D32		32	S203-D32
	40	S201-D40		40	S203-D40
	50	S201-D50		50	S203-D50
63	S201-D63	63	S203-D63		
1 + NA	0.5	S201-D0.5NA	3 + NA	0.5	S203-D0.5NA
	1	S201-D1NA		1	S203-D1NA
	1.6	S201-D1.6NA		1.6	S203-D1.6NA
	2	S201-D2NA		2	S203-D2NA
	3	S201-D3NA		3	S203-D3NA
	4	S201-D4NA		4	S203-D4NA
	6	S201-D6NA		6	S203-D6NA
	8	S201-D8NA		8	S203-D8NA
	10	S201-D10NA		10	S203-D10NA
	13	S201-D13NA		13	S203-D13NA
	16	S201-D16NA		16	S203-D16NA
	20	S201-D20NA		20	S203-D20NA
	25	S201-D25NA		25	S203-D25NA
	32	S201-D32NA		32	S203-D32NA
	40	S201-D40NA		40	S203-D40NA
	50	S201-D50NA		50	S203-D50NA
63	S201-D63NA	63	S203-D63NA		
2	0.5	S202-D0.5	4	0.5	S204-D0.5
	1	S202-D1		1	S204-D1
	1.6	S202-D1.6		1.6	S204-D1.6
	2	S202-D2		2	S204-D2
	3	S202-D3		3	S204-D3
	4	S202-D4		4	S204-D4
	6	S202-D6		6	S204-D6
	8	S202-D8		8	S204-D8
	10	S202-D10		10	S204-D10
	13	S202-D13		13	S204-D13
	16	S202-D16		16	S204-D16
	20	S202-D20		20	S204-D20
	25	S202-D25		25	S204-D25
	32	S202-D32		32	S204-D32
	40	S202-D40		40	S204-D40
	50	S202-D50		50	S204-D50
63	S202-D63	63	S204-D63		

Note: Switching neutral is noted by "NA" in the catalog number.

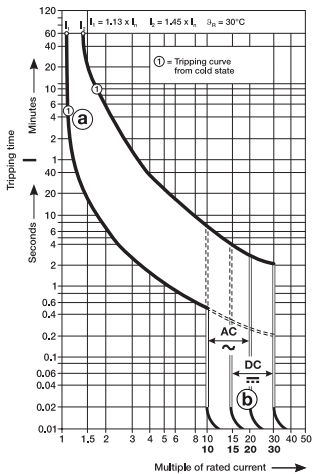

# S200-K

## Supplemental protectors—UL 1077, CSA 22.2 No. 235



Number of poles	Rated current		Number of poles	Rated current	
	$I_n$ A	Catalog number		$I_n$ A	Catalog number
1	0.5	S201-K0.5	3	0.5	S203-K0.5
	1	S201-K1		1	S203-K1
	1.6	S201-K1.6		1.6	S203-K1.6
	2	S201-K2		2	S203-K2
	3	S201-K3		3	S203-K3
	4	S201-K4		4	S203-K4
	6	S201-K6		6	S203-K6
	8	S201-K8		8	S203-K8
	10	S201-K10		10	S203-K10
	13	S201-K13		13	S203-K13
	16	S201-K16		16	S203-K16
	20	S201-K20		20	S203-K20
	25	S201-K25		25	S203-K25
	32	S201-K32		32	S203-K32
	40	S201-K40		40	S203-K40
	50	S201-K50		50	S203-K50
63	S201-K63	63	S203-K63		
1 + NA	0.5	S201-K0.5NA	3 + NA	0.5	S203-K0.5NA
	1	S201-K1NA		1	S203-K1NA
	1.6	S201-K1.6NA		1.6	S203-K1.6NA
	2	S201-K2NA		2	S203-K2NA
	3	S201-K3NA		3	S203-K3NA
	4	S201-K4NA		4	S203-K4NA
	6	S201-K6NA		6	S203-K6NA
	8	S201-K8NA		8	S203-K8NA
	10	S201-K10NA		10	S203-K10NA
	13	S201-K13NA		13	S203-K13NA
	16	S201-K16NA		16	S203-K16NA
	20	S201-K20NA		20	S203-K20NA
	25	S201-K25NA		25	S203-K25NA
	32	S201-K32NA		32	S203-K32NA
	40	S201-K40NA		40	S203-K40NA
	50	S201-K50NA		50	S203-K50NA
63	S201-K63NA	63	S203-K63NA		
2	0.5	S202-K0.5	4	0.5	S204-K0.5
	1	S202-K1		1	S204-K1
	1.6	S202-K1.6		1.6	S204-K1.6
	2	S202-K2		2	S204-K2
	3	S202-K3		3	S204-K3
	4	S202-K4		4	S204-K4
	6	S202-K6		6	S204-K6
	8	S202-K8		8	S204-K8
	10	S202-K10		10	S204-K10
	13	S202-K13		13	S204-K13
	16	S202-K16		16	S204-K16
	20	S202-K20		20	S204-K20
	25	S202-K25		25	S204-K25
	32	S202-K32		32	S204-K32
	40	S202-K40		40	S204-K40
	50	S202-K50		50	S204-K50
63	S202-K63	63	S204-K63		

Note: Switching neutral is noted by "NA" in the catalog number.

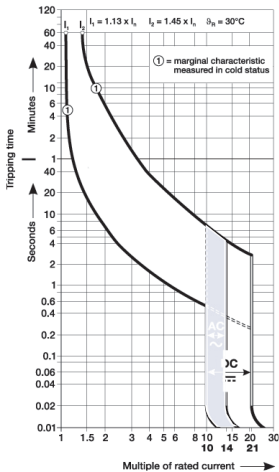

# S200-Z

## Supplemental protectors—UL 1077, CSA 22.2 No. 235



Number of poles	Rated current		Number of poles	Rated current	
	$I_n$ A	Catalog number		$I_n$ A	Catalog number
1	0.5	S201-Z0.5	3	0.5	S203-Z0.5
	1	S201-Z1		1	S203-Z1
	1.6	S201-Z1.6		1.6	S203-Z1.6
	2	S201-Z2		2	S203-Z2
	3	S201-Z3		3	S203-Z3
	4	S201-Z4		4	S203-Z4
	6	S201-Z6		6	S203-Z6
	8	S201-Z8		8	S203-Z8
	10	S201-Z10		10	S203-Z10
	13	S201-Z13		13	S203-Z13
	16	S201-Z16		16	S203-Z16
	20	S201-Z20		20	S203-Z20
	25	S201-Z25		25	S203-Z25
	32	S201-Z32		32	S203-Z32
	40	S201-Z40		40	S203-Z40
2	0.5	S202-Z0.5	4	0.5	S204-Z0.5
	1	S202-Z1		1	S204-Z1
	1.6	S202-Z1.6		1.6	S204-Z1.6
	2	S202-Z2		2	S204-Z2
	3	S202-Z3		3	S204-Z3
	4	S202-Z4		4	S204-Z4
	6	S202-Z6		6	S204-Z6
	8	S202-Z8		8	S204-Z8
	10	S202-Z10		10	S204-Z10
	13	S202-Z13		13	S204-Z13
	16	S202-Z16		16	S204-Z16
	20	S202-Z20		20	S204-Z20
	25	S202-Z25		25	S204-Z25
	32	S202-Z32		32	S204-Z32
	40	S202-Z40		40	S204-Z40
50	S202-Z50	50	S204-Z50		
63	S202-Z63	63	S204-Z63		

Note: Switching neutral is noted by "NA" in the catalog number.

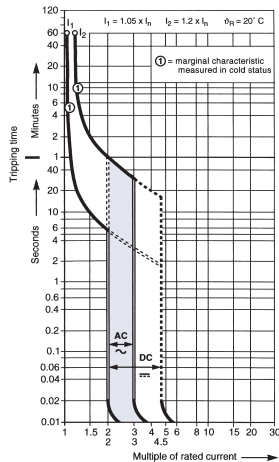

# S200P-B

## Supplemental protectors — UL 1077, CSA 22.2 No. 235

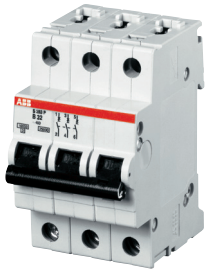
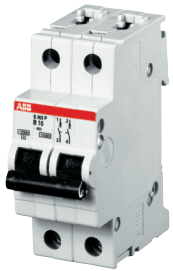

Number of poles	Rated current		Number of poles	Rated current	
	$I_n$ A	Catalog number		$I_n$ A	Catalog number
1	0.5	S201P-B0.5	3	0.5	S203P-B0.5
	1	S201P-B1		1	S203P-B1
	1.6	S201P-B1.6		1.6	S203P-B1.6
	2	S201P-B2		2	S203P-B2
	3	S201P-B3		3	S203P-B3
	4	S201P-B4		4	S203P-B4
	6	S201P-B6		6	S203P-B6
	8	S201P-B8		8	S203P-B8
	10	S201P-B10		10	S203P-B10
	13	S201P-B13		13	S203P-B13
	16	S201P-B16		16	S203P-B16
	20	S201P-B20		20	S203P-B20
	25	S201P-B25		25	S203P-B25
	32	S201P-B32		32	S203P-B32
2	0.5	S202P-B0.5	4	0.5	S204P-B0.5
	1	S202P-B1		1	S204P-B1
	1.6	S202P-B1.6		1.6	S204P-B1.6
	2	S202P-B2		2	S204P-B2
	3	S202P-B3		3	S204P-B3
	4	S202P-B4		4	S204P-B4
	6	S202P-B6		6	S204P-B6
	8	S202P-B8		8	S204P-B8
	10	S202P-B10		10	S204P-B10
	13	S202P-B13		13	S204P-B13
	16	S202P-B16		16	S204P-B16
	20	S202P-B20		20	S204P-B20
	25	S202P-B25		25	S204P-B25
	32	S202P-B32		32	S204P-B32
40	S202P-B40	40	S204P-B40		
50	S202P-B50	50	S204P-B50		
63	S202P-B63	63	S204P-B63		

Note: Switching neutral is noted by "NA" in the catalog number.

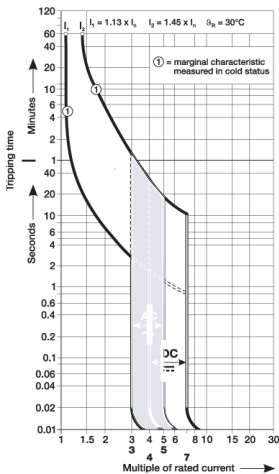

# S200P-C

## Supplemental protectors—UL 1077, CSA 22.2 No. 235

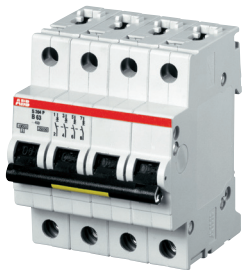
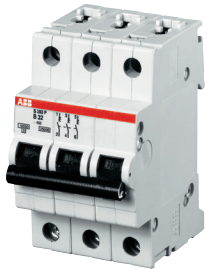
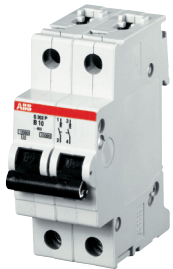

Number of poles	Rated current		Number of poles	Rated current	
	$I_n$ A	Catalog number		$I_n$ A	Catalog number
1	0.5	S201P-C0.5	3	0.5	S203P-C0.5
	1	S201P-C1		1	S203P-C1
	1.6	S201P-C1.6		1.6	S203P-C1.6
	2	S201P-C2		2	S203P-C2
	3	S201P-C3		3	S203P-C3
	4	S201P-C4		4	S203P-C4
	6	S201P-C6		6	S203P-C6
	8	S201P-C8		8	S203P-C8
	10	S201P-C10		10	S203P-C10
	13	S201P-C13		13	S203P-C13
	16	S201P-C16		16	S203P-C16
	20	S201P-C20		20	S203P-C20
	25	S201P-C25		25	S203P-C25
	32	S201P-C32		32	S203P-C32
2	0.5	S202P-C0.5	4	0.5	S204P-C0.5
	1	S202P-C1		1	S204P-C1
	1.6	S202P-C1.6		1.6	S204P-C1.6
	2	S202P-C2		2	S204P-C2
	3	S202P-C3		3	S204P-C3
	4	S202P-C4		4	S204P-C4
	6	S202P-C6		6	S204P-C6
	8	S202P-C8		8	S204P-C8
	10	S202P-C10		10	S204P-C10
	13	S202P-C13		13	S204P-C13
	16	S202P-C16		16	S204P-C16
	20	S202P-C20		20	S204P-C20
	25	S202P-C25		25	S204P-C25
	32	S202P-C32		32	S204P-C32
40	S202P-C40	40	S204P-C40		
50	S202P-C50	50	S204P-C50		
63	S202P-C63	63	S204P-C63		

Note: Switching neutral is noted by "NA" in the catalog number.

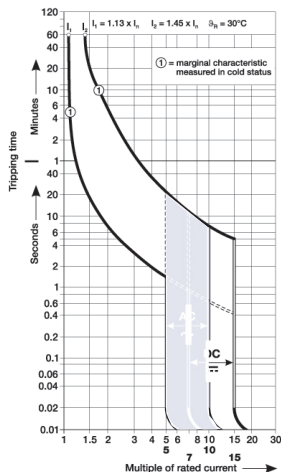



# S200P-D

## Supplemental protectors — UL 1077, CSA 22.2 No. 235

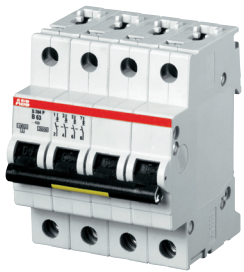
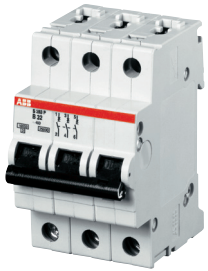
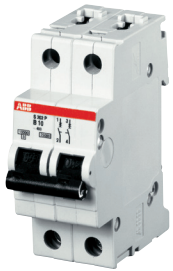

Number of poles	Rated current		Number of poles	Rated current	
	$I_n$ A	Catalog number		$I_n$ A	Catalog number
1	0.5	S201P-D0.5	3	0.5	S203P-D0.5
	1	S201P-D1		1	S203P-D1
	1.6	S201P-D1.6		1.6	S203P-D1.6
	2	S201P-D2		2	S203P-D2
	3	S201P-D3		3	S203P-D3
	4	S201P-D4		4	S203P-D4
	6	S201P-D6		6	S203P-D6
	8	S201P-D8		8	S203P-D8
	10	S201P-D10		10	S203P-D10
	13	S201P-D13		13	S203P-D13
	16	S201P-D16		16	S203P-D16
	20	S201P-D20		20	S203P-D20
	25	S201P-D25		25	S203P-D25
	32	S201P-D32		32	S203P-D32
2	0.5	S202P-D0.5	4	0.5	S204P-D0.5
	1	S202P-D1		1	S204P-D1
	1.6	S202P-D1.6		1.6	S204P-D1.6
	2	S202P-D2		2	S204P-D2
	3	S202P-D3		3	S204P-D3
	4	S202P-D4		4	S204P-D4
	6	S202P-D6		6	S204P-D6
	8	S202P-D8		8	S204P-D8
	10	S202P-D10		10	S204P-D10
	13	S202P-D13		13	S204P-D13
	16	S202P-D16		16	S204P-D16
	20	S202P-D20		20	S204P-D20
	25	S202P-D25		25	S204P-D25
	32	S202P-D32		32	S204P-D32
40	S202P-D40	40	S204P-D40		
50	S202P-D50	50	S204P-D50		
63	S202P-D63	63	S204P-D63		

Note: Switching neutral is noted by "NA" in the catalog number.

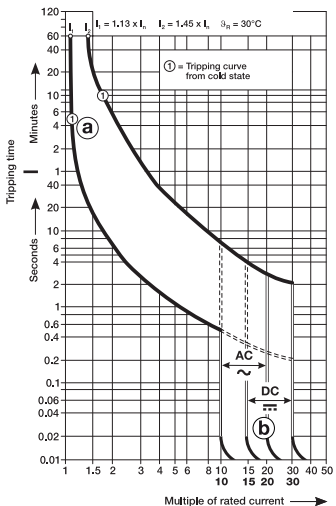

# S200P-K

## Supplemental protectors—UL 1077, CSA 22.2 No. 235

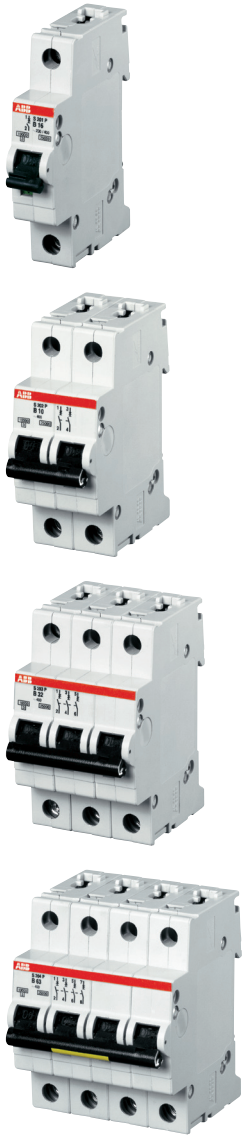

Number of poles	Rated current		Number of poles	Rated current	
	$I_n$ A	Catalog number		$I_n$ A	Catalog number
1	0.2	S201P-K0.2	3	0.2	S203P-K0.2
	0.3	S201P-K0.3		0.3	S203P-K0.3
	0.5	S201P-K0.4		0.5	S203P-K0.4
	0.75	S201P-K0.75		0.75	S203P-K0.75
	1	S201P-K1		1	S203P-K1
	1.6	S201P-K1.6		1.6	S203P-K1.6
	2	S201P-K2		2	S203P-K2
	3	S201P-K3		3	S203P-K3
	4	S201P-K4		4	S203P-K4
	6	S201P-K6		6	S203P-K6
	8	S201P-K8		8	S203P-K8
	10	S201P-K10		10	S203P-K10
	13	S201P-K13		13	S203P-K13
	16	S201P-K16		16	S203P-K16
	20	S201P-K20		20	S203P-K20
2	0.2	S202P-K0.2	4	0.2	S204P-K0.2
	0.3	S202P-K0.3		0.3	S204P-K0.3
	0.5	S202P-K0.4		0.5	S204P-K0.4
	0.75	S202P-K0.75		0.75	S204P-K0.75
	1	S202P-K1		1	S204P-K1
	1.6	S202P-K1.6		1.6	S204P-K1.6
	2	S202P-K2		2	S204P-K2
	3	S202P-K3		3	S204P-K3
	4	S202P-K4		4	S204P-K4
	6	S202P-K6		6	S204P-K6
	8	S202P-K8		8	S204P-K8
	10	S202P-K10		10	S204P-K10
	13	S202P-K13		13	S204P-K13
	16	S202P-K16		16	S204P-K16
	20	S202P-K20		20	S204P-K20
25	S202P-K25	25	S204P-K25		
32	S202P-K32	32	S204P-K32		
40	S202P-K40	40	S204P-K40		
50	S202P-K50	50	S204P-K50		
63	S202P-K63	63	S204P-K63		

Note: Switching neutral is noted by "NA" in the catalog number.

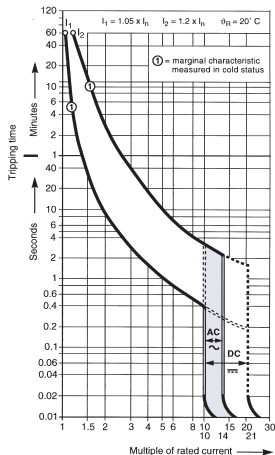



# S200P-Z

## Supplemental protectors — UL 1077, CSA 22.2 No. 235

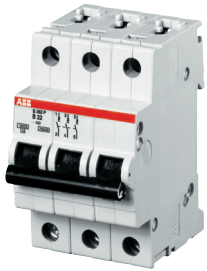
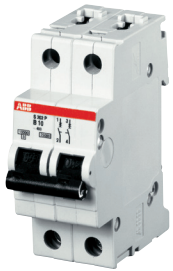

Number of poles	Rated current		Number of poles	Rated current	
	$I_n$ A	Catalog number		$I_n$ A	Catalog number
1	0.5	S201P-Z0.5	3	0.5	S203P-Z0.5
	1	S201P-Z1		1	S203P-Z1
	1.6	S201P-Z1.6		1.6	S203P-Z1.6
	2	S201P-Z2		2	S203P-Z2
	3	S201P-Z3		3	S203P-Z3
	4	S201P-Z4		4	S203P-Z4
	6	S201P-Z6		6	S203P-Z6
	8	S201P-Z8		8	S203P-Z8
	10	S201P-Z10		10	S203P-Z10
	13	S201P-Z13		13	S203P-Z13
	16	S201P-Z16		16	S203P-Z16
	20	S201P-Z20		20	S203P-Z20
	25	S201P-Z25		25	S203P-Z25
	32	S201P-Z32		32	S203P-Z32
40	S201P-Z40	40	S203P-Z40		
50	S201P-Z50	50	S203P-Z50		
63	S201P-Z63	63	S203P-Z63		
2	0.5	S202P-Z0.5	4	0.5	S204P-Z0.5
	1	S202P-Z1		1	S204P-Z1
	1.6	S202P-Z1.6		1.6	S204P-Z1.6
	2	S202P-Z2		2	S204P-Z2
	3	S202P-Z3		3	S204P-Z3
	4	S202P-Z4		4	S204P-Z4
	6	S202P-Z6		6	S204P-Z6
	8	S202P-Z8		8	S204P-Z8
	10	S202P-Z10		10	S204P-Z10
	13	S202P-Z13		13	S204P-Z13
	16	S202P-Z16		16	S204P-Z16
	20	S202P-Z20		20	S204P-Z20
	25	S202P-Z25		25	S204P-Z25
	32	S202P-Z32		32	S204P-Z32
40	S202P-Z40	40	S204P-Z40		
50	S202P-Z50	50	S204P-Z50		
63	S202P-Z63	63	S204P-Z63		

Note: Switching neutral is noted by "NA" in the catalog number.

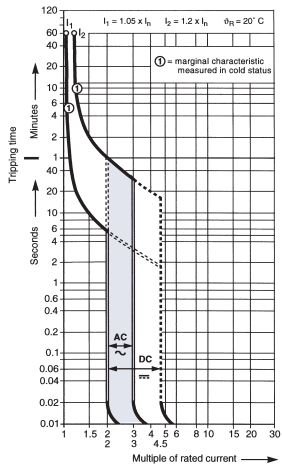

# S200MR-K with ring tongue terminals

## Supplemental protectors—UL 1077, CSA 22.2 No. 235



Number of poles	Rated current		Number of poles	Rated current	
	$I_n$ A	Catalog number		$I_n$ A	Catalog number
1	0.2	S201MR-K0.2	3	0.2	S203MR-K0.2
	0.3	S201MR-K0.3		0.3	S203MR-K0.3
	0.5	S201MR-K0.5		0.5	S203MR-K0.5
	0.75	S201MR-K0.75		0.75	S203MR-K0.75
	1	S201MR-K1		1	S203MR-K1
	1.6	S201MR-K1.6		1.6	S203MR-K1.6
	2	S201MR-K2		2	S203MR-K2
	3	S201MR-K3		3	S203MR-K3
	4	S201MR-K4		4	S203MR-K4
	5	S201MR-K5		5	S203MR-K5
	6	S201MR-K6		6	S203MR-K6
	8	S201MR-K8		8	S203MR-K8
	10	S201MR-K10		10	S203MR-K10
	13	S201MR-K13		13	S203MR-K13
	15	S201MR-K15		15	S203MR-K15
	16	S201MR-K16		16	S203MR-K16
	20	S201MR-K20		20	S203MR-K20
	25	S201MR-K25		25	S203MR-K25
30	S201MR-K30	30	S203MR-K30		
32	S201MR-K32	32	S203MR-K32		
35	S201MR-K35	35	S203MR-K35		
40	S201MR-K40	40	S203MR-K40		
50	S201MR-K50	50	S203MR-K50		
60	S201MR-K60	60	S203MR-K60		
63	S201MR-K63	63	S203MR-K63		
2	0.2	S202MR-K0.2	4	0.2	S204MR-K0.2
	0.3	S202MR-K0.3		0.3	S204MR-K0.3
	0.5	S202MR-K0.5		0.5	S204MR-K0.5
	0.75	S202MR-K0.75		0.75	S204MR-K0.75
	1	S202MR-K1		1	S204MR-K1
	1.6	S202MR-K1.6		1.6	S204MR-K1.6
	2	S202MR-K2		2	S204MR-K2
	3	S202MR-K3		3	S204MR-K3
	4	S202MR-K4		4	S204MR-K4
	5	S202MR-K5		5	S204MR-K5
	6	S202MR-K6		6	S204MR-K6
	8	S202MR-K8		8	S204MR-K8
	10	S202MR-K10		10	S204MR-K10
	13	S202MR-K13		13	S204MR-K13
	15	S202MR-K15		15	S204MR-K15
	16	S202MR-K16		16	S204MR-K16
	20	S202MR-K20		20	S204MR-K20
	25	S202MR-K25		25	S204MR-K25
30	S202MR-K30	30	S204MR-K30		
32	S202MR-K32	32	S204MR-K32		
35	S202MR-K35	35	S204MR-K35		
40	S202MR-K40	40	S204MR-K40		
50	S202MR-K50	50	S204MR-K50		
60	S202MR-K60	60	S204MR-K60		
63	S202MR-K63	63	S204MR-K63		

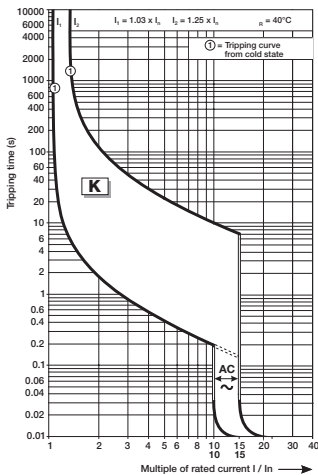

# S200MUC-C

## Supplemental protectors—UL 1077, CSA 22.2 No. 235



Number of poles	Rated current		Number of poles	Rated current	
	$I_n$ A	Catalog number		$I_n$ A	Catalog number
1	0.5	S201MUC-C0.5	3	0.5	S203MUC-C0.5
	1	S201MUC-C1		1	S203MUC-C1
	1.6	S201MUC-C1.6		1.6	S203MUC-C1.6
	2	S201MUC-C2		2	S203MUC-C2
	3	S201MUC-C3		3	S203MUC-C3
	4	S201MUC-C4		4	S203MUC-C4
	6	S201MUC-C6		6	S203MUC-C6
	8	S201MUC-C8		8	S203MUC-C8
	10	S201MUC-C10		10	S203MUC-C10
	13	S201MUC-C13		13	S203MUC-C13
	16	S201MUC-C16		16	S203MUC-C16
	20	S201MUC-C20		20	S203MUC-C20
	25	S201MUC-C25		25	S203MUC-C25
	32	S201MUC-C32		32	S203MUC-C32
2	0.5	S202MUC-C0.5	4	0.5	S204MUC-C0.5
	1	S202MUC-C1		1	S204MUC-C1
	1.6	S202MUC-C1.6		1.6	S204MUC-C1.6
	2	S202MUC-C2		2	S204MUC-C2
	3	S202MUC-C3		3	S204MUC-C3
	4	S202MUC-C4		4	S204MUC-C4
	6	S202MUC-C6		6	S204MUC-C6
	8	S202MUC-C8		8	S204MUC-C8
	10	S202MUC-C10		10	S204MUC-C10
	13	S202MUC-C13		13	S204MUC-C13
	16	S202MUC-C16		16	S204MUC-C16
	20	S202MUC-C20		20	S204MUC-C20
	25	S202MUC-C25		25	S204MUC-C25
	32	S202MUC-C32		32	S204MUC-C32
40	S202MUC-C40	40	S204MUC-C40		
50	S202MUC-C50	50	S204MUC-C50		
63	S202MUC-C63	63	S204MUC-C63		

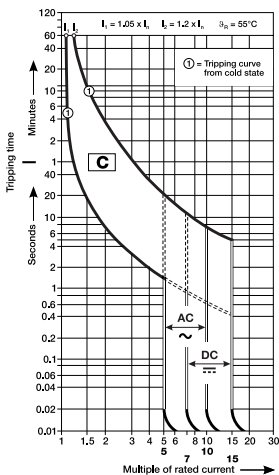

# S200MUC-K

## Supplemental protectors—UL 1077, CSA 22.2 No. 235



Number of poles	Rated current		Number of poles	Rated current	
	$I_n$ A	Catalog number		$I_n$ A	Catalog number
1	0.2	S201MUC-K0.2	3	0.2	S203MUC-K0.2
	0.3	S201MUC-K0.3		0.3	S203MUC-K0.3
	0.5	S201MUC-K0.5		0.5	S203MUC-K0.5
	0.75	S201MUC-K0.75		0.75	S203MUC-K0.75
	1	S201MUC-K1		1	S203MUC-K1
	1.6	S201MUC-K1.6		1.6	S203MUC-K1.6
	2	S201MUC-K2		2	S203MUC-K2
	3	S201MUC-K3		3	S203MUC-K3
	4	S201MUC-K4		4	S203MUC-K4
	5	S201MUC-K5		5	S203MUC-K5
	6	S201MUC-K6		6	S203MUC-K6
	8	S201MUC-K8		8	S203MUC-K8
	10	S201MUC-K10		10	S203MUC-K10
	13	S201MUC-K13		13	S203MUC-K13
	15	S201MUC-K15		15	S203MUC-K15
	16	S201MUC-K16		16	S203MUC-K16
	20	S201MUC-K20		20	S203MUC-K20
	2	0.2		S202MUC-K0.2	4
0.3		S202MUC-K0.3	0.3	S204MUC-K0.3	
0.5		S202MUC-K0.5	0.5	S204MUC-K0.5	
0.75		S202MUC-K0.75	0.75	S204MUC-K0.75	
1		S202MUC-K1	1	S204MUC-K1	
1.6		S202MUC-K1.6	1.6	S204MUC-K1.6	
2		S202MUC-K2	2	S204MUC-K2	
3		S202MUC-K3	3	S204MUC-K3	
4		S202MUC-K4	4	S204MUC-K4	
5		S202MUC-K5	5	S204MUC-K5	
6		S202MUC-K6	6	S204MUC-K6	
8		S202MUC-K8	8	S204MUC-K8	
10		S202MUC-K10	10	S204MUC-K10	
13		S202MUC-K13	13	S204MUC-K13	
15		S202MUC-K15	15	S204MUC-K15	
16		S202MUC-K16	16	S204MUC-K16	
20		S202MUC-K20	20	S204MUC-K20	
25		S202MUC-K25	25	S204MUC-K25	
30	S202MUC-K30	30	S204MUC-K30		
32	S202MUC-K32	32	S204MUC-K32		
35	S202MUC-K35	35	S204MUC-K35		
40	S202MUC-K40	40	S204MUC-K40		
50	S202MUC-K50	50	S204MUC-K50		
60	S202MUC-K60	60	S204MUC-K60		
63	S202MUC-K63	63	S204MUC-K63		

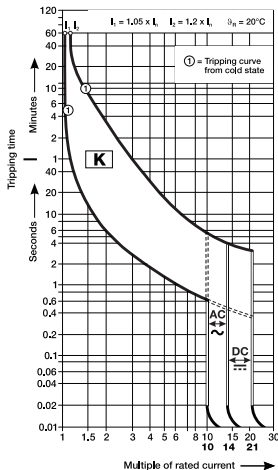

# S200MUC-Z

## Supplemental protectors — UL 1077, CSA 22.2 No. 235



Number of poles	Rated current		Number of poles	Rated current	
	$I_n$ A	Catalog number		$I_n$ A	Catalog number
1	0.5	S201MUC-Z0.5	3	0.5	S203MUC-Z0.5
	1	S201MUC-Z1		1	S203MUC-Z1
	1.6	S201MUC-Z1.6		1.6	S203MUC-Z1.6
	2	S201MUC-Z2		2	S203MUC-Z2
	3	S201MUC-Z3		3	S203MUC-Z3
	4	S201MUC-Z4		4	S203MUC-Z4
	5	S201MUC-Z5		5	S203MUC-Z5
	6	S201MUC-Z6		6	S203MUC-Z6
	8	S201MUC-Z8		8	S203MUC-Z8
	10	S201MUC-Z10		10	S203MUC-Z10
	15	S201MUC-Z15		15	S203MUC-Z15
	16	S201MUC-Z16		16	S203MUC-Z16
	20	S201MUC-Z20		20	S203MUC-Z20
	25	S201MUC-Z25		25	S203MUC-Z25
2	30	S201MUC-Z30	4	30	S203MUC-Z30
	32	S201MUC-Z32		32	S203MUC-Z32
	35	S201MUC-Z35		35	S203MUC-Z35
	40	S201MUC-Z40		40	S203MUC-Z40
	50	S201MUC-Z50		50	S203MUC-Z50
	60	S201MUC-Z60		60	S203MUC-Z60
	63	S201MUC-Z63		63	S203MUC-Z63
	0.5	S202MUC-Z0.5		0.5	S204MUC-Z0.5
	1	S202MUC-Z1		1	S204MUC-Z1
	1.6	S202MUC-Z1.6		1.6	S204MUC-Z1.6
	2	S202MUC-Z2		2	S204MUC-Z2
	3	S202MUC-Z3		3	S204MUC-Z3
	4	S202MUC-Z4		4	S204MUC-Z4
	5	S202MUC-Z5		5	S204MUC-Z5
6	S202MUC-Z6	6	S204MUC-Z6		
8	S202MUC-Z8	8	S204MUC-Z8		
10	S202MUC-Z10	10	S204MUC-Z10		
15	S202MUC-Z15	15	S204MUC-Z15		
16	S202MUC-Z16	16	S204MUC-Z16		
20	S202MUC-Z20	20	S204MUC-Z20		
25	S202MUC-Z25	25	S204MUC-Z25		
30	S202MUC-Z30	30	S204MUC-Z30		
32	S202MUC-Z32	32	S204MUC-Z32		
35	S202MUC-Z35	35	S204MUC-Z35		
40	S202MUC-Z40	40	S204MUC-Z40		
50	S202MUC-Z50	50	S204MUC-Z50		
60	S202MUC-Z60	60	S204MUC-Z60		
63	S202MUC-Z63	63	S204MUC-Z63		

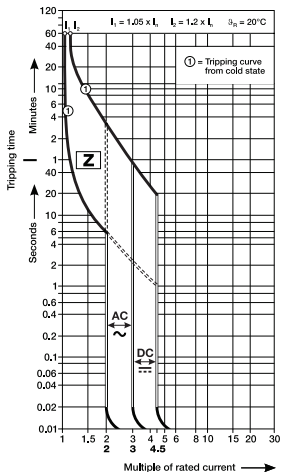



# Accessories

## S200, S200P, S200MR, and S200MUC—UL 1077, CSA 22.2 No. 235



S2C-H6...

### Auxiliary contacts

The auxiliary contacts will signal whether the breaker is in the ON or OFF position.

Description	Catalog number
For field mounting: right side	
Auxiliary contact 1CO	S2C-H6R
Auxiliary contact 1NO/1NC	S2C-H6-11R
Auxiliary contact 2NO	S2C-H6-20R
Auxiliary contact 2NC	S2C-H6-02R



S2C-A

### Bell alarm—signal contact

The bell alarm includes a set of contacts that will only signal when the breaker has tripped. Typically, the contacts would be connected to an alarm or bell to signal the operator that an overcurrent trip has occurred. The bell alarm also includes a test button for testing the alarm contacts without opening the breaker.

Description	Catalog number
For field mounting: right side	S2C-S/H6R



S2C-A

### Shunt trip

For remote tripping of breaker, a shunt trip device can be added to the MCB. The solenoid device opens the breaker after control voltage is applied.

Description	Catalog number
For field mounting: right side	
A1-12-60 VAC (12-60 VDC)	S2C-A1
A2-110-415 VAC (110-250 VDC)	S2C-A2



S2C-UA

### Undervoltage release

When control voltage drops below approximately 50 percent of rated voltage, the UVR opens the breaker. The breaker can not be operated unless proper control voltage is first applied to the UVR coil.

Description	Catalog number
For field mounting: right side	
12 VDC	S2C-UA12DC
24 VAC or VDC	S2C-UA24AC or S2C-UA24DC
48 VAC or VDC	S2C-UA48AC or S2C-UA48DC
110 VAC or VDC	S2C-UA110AC or S2C-UA110DC
230 VAC or VDC	S2C-UA230AC or S2C-UA230DC
400 VAC	S2C-UA400AC



SA1



SA2

### Locking device

Description	Catalog number
Locking device, 3 mm	SA1
Padlock with two keys	SA2

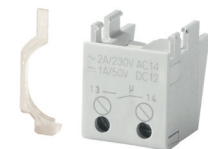

S2C-H01

### Bottom-fitted auxiliary contact

Description	Catalog number
Auxiliary contact 1 NC	S2C-H01
Auxiliary contact 1 NO	S2C-H10

# Accessories

## S200, S200P, S200MUC, and S200MR—UL 1077, CSA 22.2 No. 235

### Accessory overview

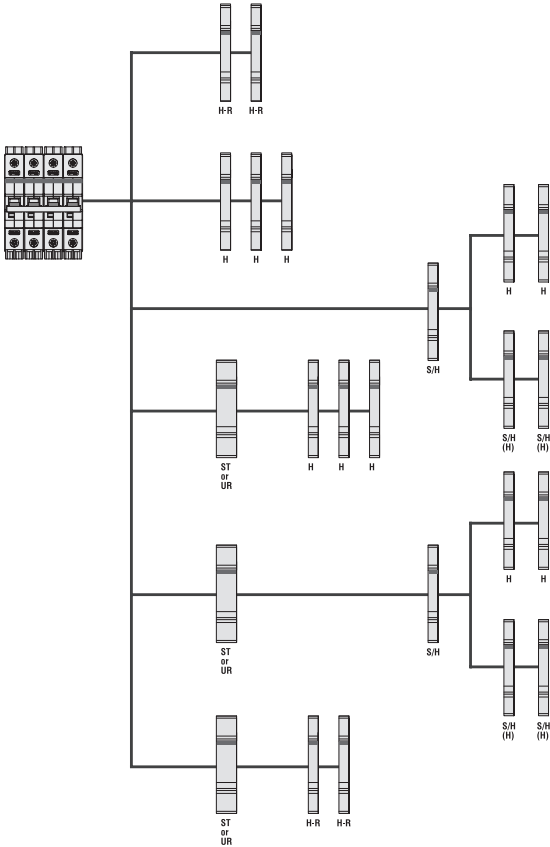

- H Auxiliary contact S2C-H6R
- H-R Auxiliary contact S2C-H6-...R
- S/H Signal/auxiliary contact S2C-S/H6R
- S/H (H) Signal/auxiliary contact S2C-S/H6R used as auxiliary contact
- ST Shunt trip S2C-A...
- UR Undervoltage release S2C-UA

### SU200MR Instructions for use

**Ring Tongue Terminal, Special purpose - Not for general use**

**Installation Instructions**

Please insert or withdraw the cable lug only when the screw is completely open.

Please make sure that the terminal screw penetrates the ring lug hole properly and completely during tightening.

Please ensure that the screw is securely tightened before applying any mechanical force on the cable / cable lug.

Do not apply abnormal downward pressure on the screw during tightening or loosening of the screw.

Please follow the Ring Tongue Details on the rear of this sheet.

**Ring Tongue Details**

Only  or  ring cable lugs	Insulated only 	A	B	C
		Rated voltage 480Y/277 V AC	max. 11.0 mm (0.43")	max. 12.2 mm (0.48")
Rated voltage 240/240 V AC	Insulated only 	max. 14.0 mm (0.55")	max. 12.2 mm (0.48")	Suitable for M5 (0.20")

CU only  
60/75°C  
(140/167°F)

max. 2.0 mm  
(0.08")

PZ 2 Torque: 2.8 Nm (25lb-in)

# Accessories

## S200, S200P, and S200MUC

### UL 1077, CSA 22.2 No. 235 (suitable for cutting)

#### Busbars (suitable for cutting) UL 1077 suitable for MCBs S200 and S200P

##### 1-phase busbars, pin distance 17.6 mm, end caps PS-END 0

Number of pins	Phases	mm <sup>2</sup>	Catalog number
60	1	10	PS 1/60 SP
60	1	16	PS 1/60/16 SP

##### 1-phase busbars, connection of 1-pole devices with auxiliary, PS-END 0

Number of pins	Phases	mm <sup>2</sup>	Catalog number
38	1	10	PS 1/38H SP
38	1	16	PS 1/38/16H SP

##### 2-phase busbars, pin distance 17.6 mm, end caps PS-END SP

Number of pins	Phases	mm <sup>2</sup>	Catalog number
58	2	10	PS 2/58 SP
58	2	16	PS 2/58/16 SP

##### 2-phase busbars, connection of 2-pole devices with auxiliary, end caps PS-END SP

Number of pins	Phases	mm <sup>2</sup>	Catalog number
48	2	16	PS 2/48/16 HSP

##### 3-phase busbars, pin distance 17.6 mm, end caps PS-END SP

Number of pins	Phases	mm <sup>2</sup>	Catalog number
60	3	10	PS 3/60 SP
60	3	16	PS 3/60/16 SP

##### 3-phase busbars, connection of 3-pole devices with auxiliary, end caps PS-END SP

Number of pins	Phases	mm <sup>2</sup>	Catalog number
48	3	16	PS 3/48/16 HSP

##### 4-phase busbars, pin distance 17.6 mm, PS-END 1 SP

No. of pins	Phases	mm <sup>2</sup>	Catalog number
60	4	16	PS 4/60/16 SP

##### 4-phase busbars, connection of 4-pole devices with auxiliary, end caps PS-END 1 SP

Number of pins	Phases	mm <sup>2</sup>	Catalog number
52	4	16	PS 4/52/16H SP



# Accessories

## S200, S200P, and S200MUC

### UL 1077, CSA 22.2 No. 235 (suitable for cutting)

#### Busbars (suitable for cutting) UL 1077 suitable for MCBs S200 and S200P

4-phase busbars, connection of 1+N and RCBO, end caps PS-END 1 SP

Number of pins	Phases	mm <sup>2</sup>	Catalog number
58	4	16	PS4/58/16N SP

#### Shock-protection caps for PS...SP (UL 1077)

Number of pins	Phases	mm <sup>2</sup>	Catalog number
	5 parts		BSK SP

#### Feeder terminals for PS...SP (UL 1077)

Terminal, insulated with pin contact

Conn. capacity mm <sup>2</sup>	Catalog number
35	AST 35/15 SP

#### Feeder Terminal single-pole terminal, can be mounted side by side, feed on the pin of the busbar

Conn. capacity mm <sup>2</sup>	Catalog number
50	SZ-ESK SP

#### Suitable for MCBs S 200 and S200 P - UL 1077 (Supplementary protectors)

##### Technical specifications

Technical specifications		Feeder terminals SZ-ESK SP, AST 35/15 SP
Max. operating voltage		480 VAC
Max. current		115 A <sup>1)</sup>
Protection degree		IP 20
Wire range		SZ-ESK SP: 35 mm <sup>2</sup> / 2AWG flexible with ferrule 50 mm <sup>2</sup> / 1AWG solid/stranded
		AST 35/15 SP: 25 mm <sup>2</sup> / 3AWG flexible with ferrule 35 mm <sup>2</sup> / 2AWG solid/stranded

<sup>1)</sup>Regardless of the rated current of the feeder terminal the maximum current rating of the device terminal.

# Technical specifications

## S200, S200P, S200MR, S200MUC—UL 1077, CSA 22.2 No. 235

### Technical specifications

	S200	S200P	S200MR	S200MUC
Number of poles	1, 2, 3, 4	1, 2, 3, 4	1, 2, 3, 4	1, 2, 3, 4
Trip curves	B, C, D, K, Z	B, C, D, K, Z	K	C, K, Z
Rated current	0.5-63 A	0.2-63 A	0.2-63 A	0.2-63 A
Rated voltage	277/Y480 VAC 60/110 VDC (1/2-pole)	277/Y480 VAC	277/Y480 VAC	277/Y480 VAC 250/500 VDC (1/2-pole)
Short circuit interrupt rating	6 kA	10 kA (up to 25 A) 6 kA (32-63 A)	10 kA	10 kA (DC) 6 kA (AC)
Calibration temperature	25 °C	25 °C	25 °C	25 °C
Protection degree	IP 20	IP 20	IP 20	IP 20
Mounting position	Any	Any	Any	Any
Mounting/installation	35 mm DIN rail	35 mm DIN rail	35 mm DIN rail	35 mm DIN rail
Terminal/cable size	AWG 18-4	AWG 18-4	AWG 18-4	AWG 18-4
Service life, mechanical	20,000 operations	20,000 operations	20,000 operations	20,000 operations
Ambient temperature	-25 °C to +55 °C	-25 °C to +55 °C	-25 °C to +55 °C	-25 °C to +55 °C
Shock resistance (IEC 60068-2-27)	25 g - 2 shocks - 13 ms	25 g - 2 shocks - 13 ms	25 g - 2 shocks - 13 ms	25 g - 2 shocks - 13 ms

### Auxiliary contact S2C-H6R and signal contact S2C-S6R

Rated current	10
Rated voltage AC/DC	24
Contact	1 pole, single throw
Connection capacity mm <sup>2</sup>	18-14 AWG (0.75...2.5)
Tightening torque	11 in. lbs (1.2 Nm)
Shock resistance acc. to DIN IEC 68-2-6	5 g, 20 frequency cycles 5...150...5 Hz at 24 VAC/DC, 5 mA auto-reclosing < 10 ms
Mechanical service life	10,000 operations

### Shunt trip

		S2C-A1	S2C-A2
Rated voltage	AC	12...60 V	110...415 V
	DC	12...60 V	110...250 V
Maximum release duration		<10 ms	<10 ms
Minimum release voltage	AC	7 V	55 V
	DC	10 V	80 V
Consumption on release	AC	40...200 VA	55...210 VA
	DC	40...200 VA	55...110 VA
Coil resistance		3.7 Ω	225 Ω
Terminals		18...6/0.75-16 AWG/mm <sup>2</sup>	18...6/0.75-16 AWG/mm <sup>2</sup>
Tightening torque		18/2 in. lbs/Nm	18/2 in. lbs/Nm

### Undervoltage release

		S2C-UA 12 DC	S2C-UA 24 AC	S2C-UA 24 DC	S2C-UA 48 AC	S2C-UA 48 DC	S2C-UA 110 AC	S2C-UA 110 DC	S2C-UA 230 AC	S2C-UA 230 DC	S2C-UA 400 AC
Standards		IEC/EN 60947-1110...415 V									
Rated voltage	AC	12 V	24 V	24 V	48 V	48 V	110 V	110 V	230 AC	230 V	400 V
	DC	12 V		24 V		48 V		110 V		230 V	
Frequency		50 ... 60 HZ									
Release trip		0.35 UnOVO 0.7 Un V									
Terminals		2 x 16/2 x 1.5 AWG/mm <sup>2</sup>									
Consumption		0.2 VA	3.6 VA	2 VA	3.6 VA	2.1 VA	3.5 VA	2.2 VA	3.7 VA	2.3 VA	2.4 VA
Resistance to corrosion		constant atmosphere: 23/83 – 40/93 – 55/20; variable atmosphere: 25/95 – 40/93 °C/RH									
Protection degree		IPXXB / IP2X									
Tightening torque		3.5/0.4 in. lbs/Nm									

# Technical specifications

## S200, S200P, and S200MR—UL 1077, CSA 22.2 No. 235

### Internal resistance and power loss per pole

Internal resistance per pole in mΩ, power loss per pole in W.

#### S200 and S200P

Type	Rated current $I_n$	Device series B, C, D <sup>1)</sup>		Device series K		Device series Z	
		mΩ	W	mΩ	W	mΩ	W
S200 and S200P	A						
	0.5	5500	1.4	6340	1.6	10100	2.5
	1	1440	1.4	1550	1.6	2270	2.3
	1.6	630	1.6	695	1.8	1100	2.8
	2	460	1.8	460	1.9	619	2.5
	3	150	1.3	165	1.5	202	1.8
	4	110	1.8	120	2.0	149	2.4
	6	55	2.0	52	1.9	104	3.7
	8	15	1.0	38	1.5	53.9	3.45
	10	13.3	1.3	12.6	2.0	17.5	1.7
	13	13.3	2.3	12.6	1.26	—	—
	16	7.0	1.8	7.7	2.0	10.9	2.8
	20	6.25	2.5	6.7	2.7	6.0	2.4
	25	5.0	3.2	4.6	2.9	4.1	2.6
	32	3.6	3.7	3.5	3.6	2.8	2.9
	40	3.0	4.8	2.8	4.5	2.5	4.1
	50	1.3	3.25	1.25	2.9	1.8	4.4
63	1.2	4.8	0.7	5.2	1.3	5.2	

<sup>1)</sup>Current intensities 0.5-4 apply exclusively to C-type trip characteristics.

#### S200MR

Rated current A	Internal resistance per pole mΩ	Power loss per pole W
0.2	25300	1.01
0.3	13700	1.23
0.5	4740	1.19
0.75	2067	1.16
1	1270	1.27
1.5	610	1.56
2	442	1.77
3	140	1.26
4	109	1.75
5	50	1.26
6	54	1.94
8	22	1.41
10	18.2	1.82
13	14.8	2.50
15	8.1	1.83
16	11.1	2.83
20	8.5	3.40
25	5.5	3.43
30	3.8	3.39
32	4.6	4.70
35	3.9	4.76
40	2.8	4.40
50	1.7	4.25
60	1.7	6.18
63	1.9	7.56

### Temperature derating

Max operating current depending on the ambient temperature of a circuit breaker characteristics type B, C and D

B, C, D, K, and Z	Ambient temperatures T (C°/F°)											
	-40/-40	-30/-22	-20/-4	-10/14	0/32	10/50	20/68	30/86	40/104	50/122	60/140	70/158
Amps	0.67	0.65	0.62	0.60	0.58	0.55	0.53	0.50	0.47	0.44	0.41	0.37
	1.33	1.29	1.25	1.20	1.15	1.11	1.05	1.00	0.94	0.88	0.82	0.75
	2.13	2.07	2.00	1.92	1.85	1.77	1.69	1.60	1.51	1.41	1.31	1.19
	2.67	2.58	2.49	2.40	2.31	2.21	2.11	2.00	1.89	1.76	1.63	1.49
	4.0	3.9	3.7	3.6	3.5	3.3	3.2	3.0	2.8	2.6	2.4	2.2
	5.3	5.2	5.0	4.8	4.6	4.4	4.2	4.0	3.8	3.5	3.3	3.0
	8.0	7.7	7.5	7.2	6.9	6.6	6.3	6.0	5.7	5.3	4.9	4.5
	10.7	10.3	10.0	9.6	9.2	8.8	8.4	8.0	7.5	7.1	6.5	6.0
	13.3	12.9	12.5	12.0	11.5	11.1	10.5	10.0	9.4	8.8	8.2	7.5
	17.3	16.8	16.2	15.6	15.0	14.4	13.7	13.0	12.3	11.5	10.6	9.7
	21.3	20.7	20.0	19.2	18.5	17.7	16.9	16.0	15.1	14.1	13.1	11.9
	26.7	25.8	24.9	24.0	23.1	22.1	21.1	20.0	18.9	17.6	16.3	14.9
	33.3	32.3	31.2	30.0	28.9	27.6	26.4	25.0	23.6	22.0	20.4	18.6
	42.7	41.3	39.9	38.5	37.0	35.4	33.7	32.0	30.2	28.2	26.1	23.9
	53.3	51.6	49.9	48.1	46.2	44.2	42.2	40.0	37.7	35.3	32.7	29.8
	66.7	64.5	62.4	60.1	57.7	55.3	52.7	50.0	47.1	44.1	40.8	37.3
	84.0	81.3	78.6	75.7	72.7	69.6	66.4	63.0	59.4	55.6	51.4	47.0
112.6	107.2	102.1	97.2	92.6	88.2	84.0	80.0	76.0	72.2	68.6	65.2	
140.7	134.0	127.6	121.6	115.8	110.3	105.0	100.0	95.0	90.3	85.7	81.5	
175.9	167.5	159.5	151.9	144.7	137.8	131.3	125.0	118.8	113.8	107.2	101.8	

# Miniature circuit breaker S200MUC

## Use of MCBs in direct current circuits

S200MUC miniature circuit breakers can be used in the 1 pole version at 250 VDC, and in the 2-pole or 4-pole version with series connection of two poles up to 500 VDC.

S200MUC differs from the standard S200 type. It is equipped with permanent magnets that assist in the forced extinguishing of the arc.

If voltages to ground exceeding 250 VDC occur, 2-pole S200MUC should be used for one-pole disconnection and four-pole S200MUC for all-pole disconnection.

### For DC incoming supply from above

S200MUC MCBs have permanent magnets in the area of arc chutes. Therefore, it is necessary to take into account the polarity during the installation process. In the case of a short circuit, the magnetic field of the permanent magnets corresponds with the electromagnetic field of the short-circuit current, therefore, safely leading the short circuit into the arc chute. Incorrect polarities may cause damage to the MCB. As a result for top-fed devices, terminal 1 must be connected to (-) and terminal 3 to (+).

### Examples of permissible voltages between the conductors depending on the number of poles and circuit layout:

Voltage between conductors $U_n$	250 VDC	500 VDC	500 VDC	500 VDC	500 VDC
Voltage between conductor and ground $U_n$	250 VDC	250 VDC	500 VDC	250 VDC	250 VDC
MCB	1-pole S201MUC	2-pole S202MUC	2-pole S202MUC	2-pole S202MUC	4-pole S204MUC
Supply from below					
Supply from above					

1 in the circuit diagram, the negative pole is earthed.

2 in the circuit diagram, the positive pole is earthed.

### Examples of permissible voltages between the conductors depending on the number of poles and circuit layout:

Voltage between conductors $U_n$	500 VDC all-pole disconnection	500 VDC 1-pole disconnection	500 VDC all-pole disconnection
Voltage between conductor and ground $U_n$	250 VDC– circuit symmetrically grounded	250 VDC– unsymmetrically grounded	250 VDC– circuit ungrounded or unsymmetrically grounded
MCB	2-pole S202MUC	2-pole S202MUC	4-pole S204MUC
Supply from below			

1 in the circuit diagram, the negative pole is earthed.

2 in the circuit diagram, the positive pole is earthed.

# Approximate dimensions

## S200, S200P, S200MR, and S200MUC—UL 1077, CSA 22.2 No. 235

### S200, S200P, S200MUC

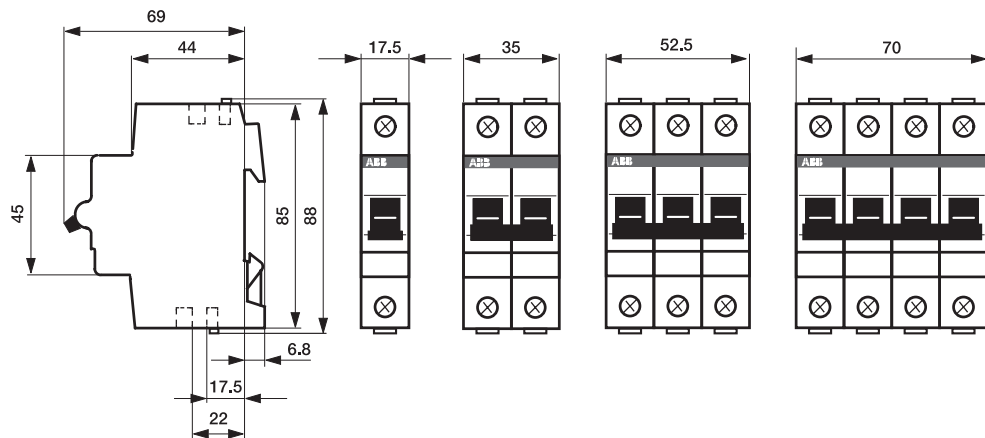

### S200MR

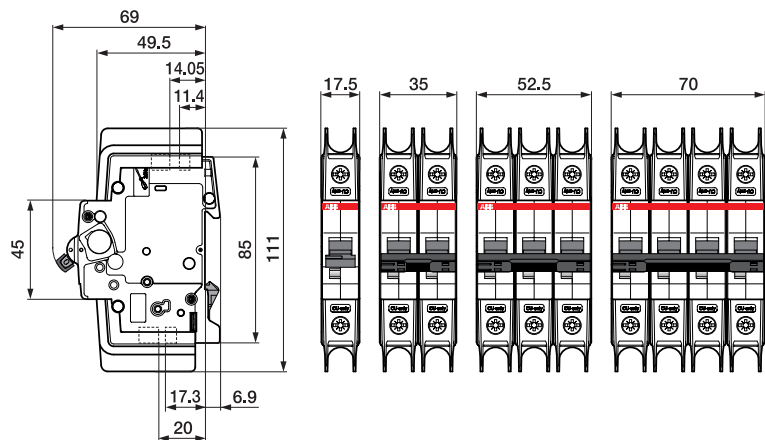

# Application guide—Miniature circuit breaker

## Introduction

The circuit breaker plays an important role in providing over-current protection and a disconnect means in electrical networks. Recent advancements in circuit breaker technology has increased breaker performance and protection.

## Overload

An overload is a slow and small overcurrent situation that causes the ampacity and temperature of the circuit to gradually increase over time. This type of event is characterized by a slight increase in the load (ampacity) on the circuit and is interrupted by the thermal trip unit of the breaker.

### Thermal Example

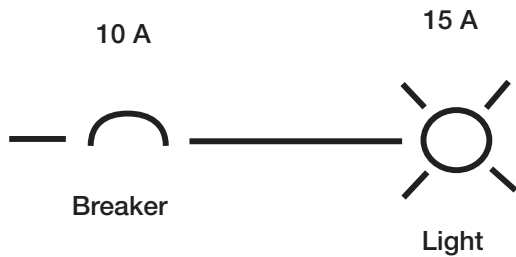

The light draws more than 10 amps for an extended period of time creating a thermal overload.

## Short circuit

A short circuit is a rapid and intense overcurrent situation that causes the ampacity of the circuit to increase. This type of event is characterized by a dramatic increase in the load (ampacity) on the circuit and is interrupted by the magnetic trip unit of the breaker.

### Magnetic Example

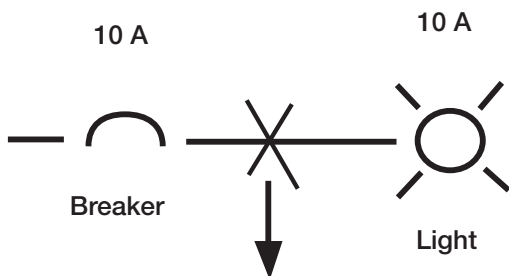

The wire connected between the light and breaker is cut and shorted to ground creating a short circuit.

## Breaker definition

A breaker is a device designed to isolate a circuit during an overcurrent event without the use of a fusible element. A breaker is a resettable protective device that protects against two types of overcurrent situations: overload and short circuit.

## ABB current limiting breaker

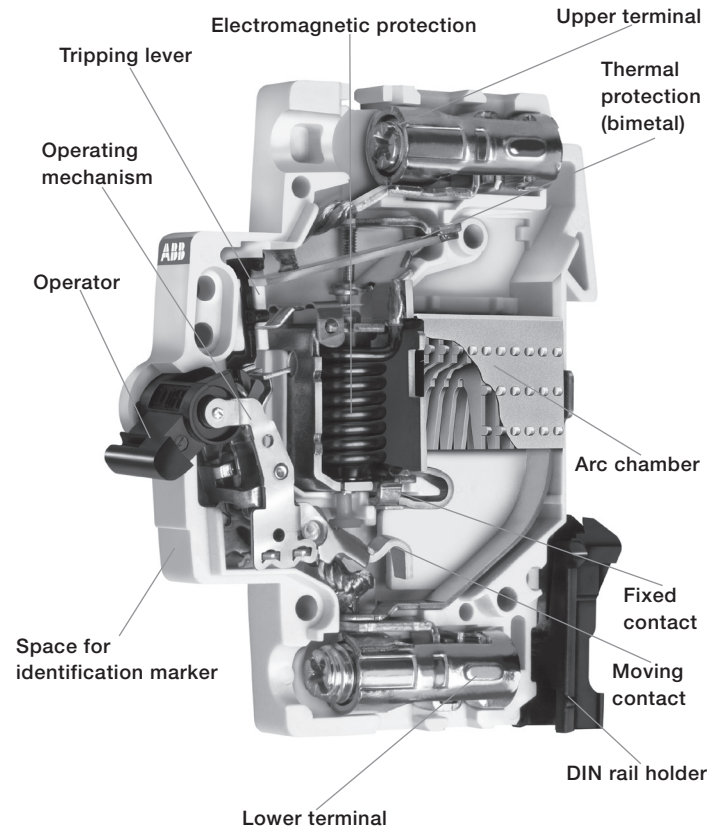

# Circuit breaker construction

## Thermal/Magnetic trip units definition

ABB Current Limiting Breakers use an electromechanical (Thermal/Magnetic) trip unit to open the breaker contacts during an overcurrent event. The thermal trip unit is temperature sensitive and the magnetic trip unit is current sensitive. Both units act independently and mechanically with the breaker's trip mechanism to open the breaker's contacts.

## Current flow during operation

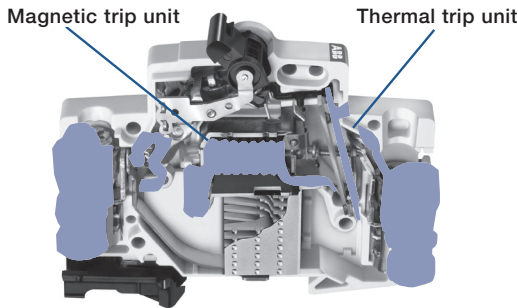

All highlighted components are energized during operation

## Overload protection

The thermal trip unit protects against a continuous overload. The thermal unit is comprised of a bimetal element located behind the circuit breaker trip bar and is part of the breaker's current carrying path. When there is an overload, the increased current flow heats the bimetal causing it to bend. As the bimetal bends, it pulls the trip bar that opens the breaker's contacts.

The time required for the bimetal to bend and trip the breaker varies inversely with the current. Because of this, the tripping time becomes quicker as current increases in magnitude.

Overload protection is applicable to any installation, conductor, or component that can be subjected to low-magnitude but long-time overcurrents. Low-magnitude, long-time overcurrents can be dangerous because they reduce the life of the electrical installation, conductor, and components. If left unchecked, fire could result.

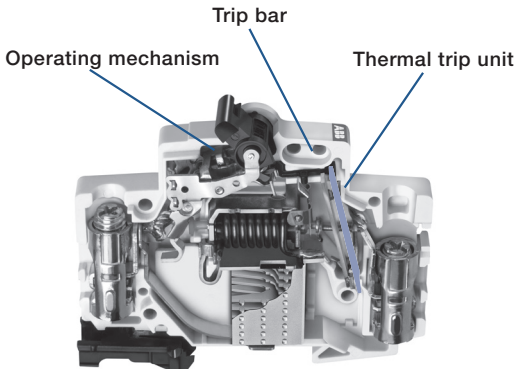

## Magnetic trip units (short circuit protection)

The magnetic trip unit protects against a short circuit. The magnetic trip unit is comprised of an electromagnet and an armature.

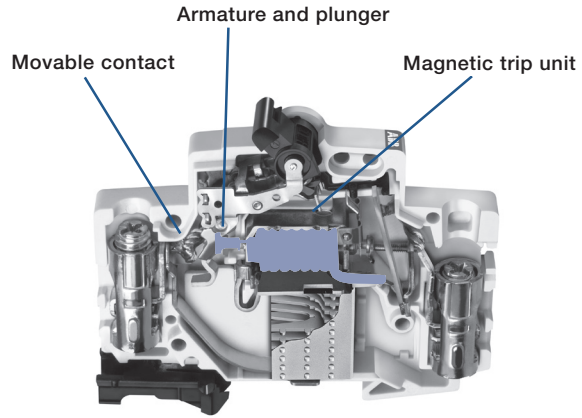

## Components of a magnetic trip unit

When there is a short circuit, a high magnitude of current passes through the coils creating a magnetic field that attracts the movable armature towards the fixed armature. The hammer trip is pushed against the movable contact and the contacts are opened. The opening of the breaker's contacts during a short circuit is complete in .5 milli-seconds.

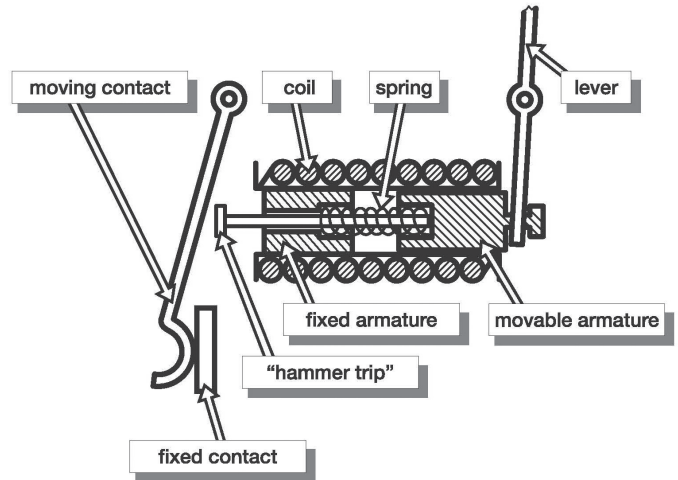



# Circuit breaker construction

## Arc runners/arc chutes

The arc runner guides the electric arc away from the open contacts into the arc chute where it is extinguished.

During an overload or short circuit event, the contacts of the breaker separate, and an electrical arc is formed between the contacts through air. The arc is moved into the arc chute by “running” the arc down the interior of the breaker along the arc runner. When the arc reaches the arc chute, it is broken into small segmented arcs. The segmented arcs split the overall energy level into segments less than 25 V. Each 25 V segment does not have a high enough energy level to maintain an arc and all energy is naturally dissipated.

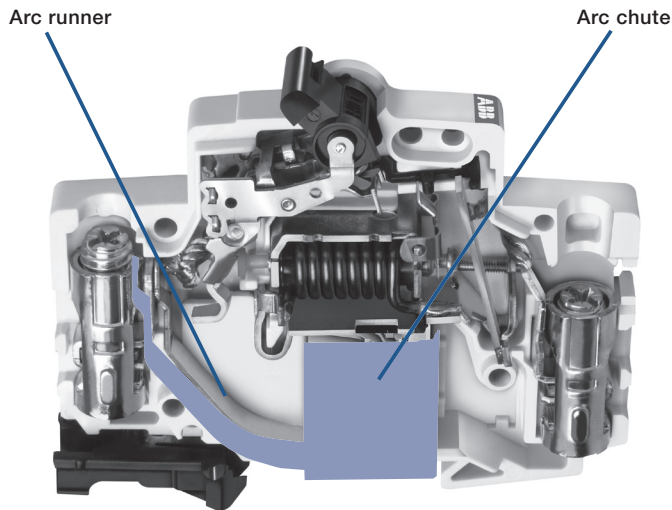

## Breaker curves

### Thermal trip unit (region one)

The first sloping region of the breaker curve is a graphical representation of the tripping characteristics of the thermal trip unit. This portion of the curve is sloped due to the nature of the thermal trip unit. The trip unit bends to trip the breaker’s trip bar in conjunction with a rise in amperage (temperature) over time. As the current on the circuit increases, the temperature rises, the faster the thermal element will trip.

Example using the curve below: If you had a 10 A breaker and the circuit was producing 30 amps of current, the breaker would trip between two seconds and one minute. In this example, you would find the circuit current on the bottom of the graph (multiples of rated current). The first line is 10 amps (10 amp breaker x a multiple of one), the second line is 20 amps (10 amp breaker x multiple of two), and the third line is 30 amps (10 amp breaker x multiple of three). Next, you would trace the vertical 30 A line up until it intersects the red portion of the breaker thermal curve. If you follow the horizontal lines on both sides of the red curve to the left, you will see that the breaker can trip as fast as two seconds and no slower than one minute.

### Magnetic trip unit (region two)

This region of the breaker curve is the instantaneous trip unit. ABB’s miniature circuit breaker’s instantaneous trip unit interrupts a short circuit in 2.3 to 2.5 milliseconds. Because of this, the curve has no slope and is graphically represented as a vertical straight line.

See curve example. If you had a 10 amp breaker, the magnetic trip element would interrupt a short circuit between 10 and 30 amps (10 amp breaker x multiple of two and three) in 2.3 to 2.5 milliseconds.

### Breaker contacts (region three)

This region of the curve is the time required for the contacts of the breaker to begin to separate. The contacts will open in less than .5 milliseconds and is graphically represented by the bottom vertical portion of the curve.

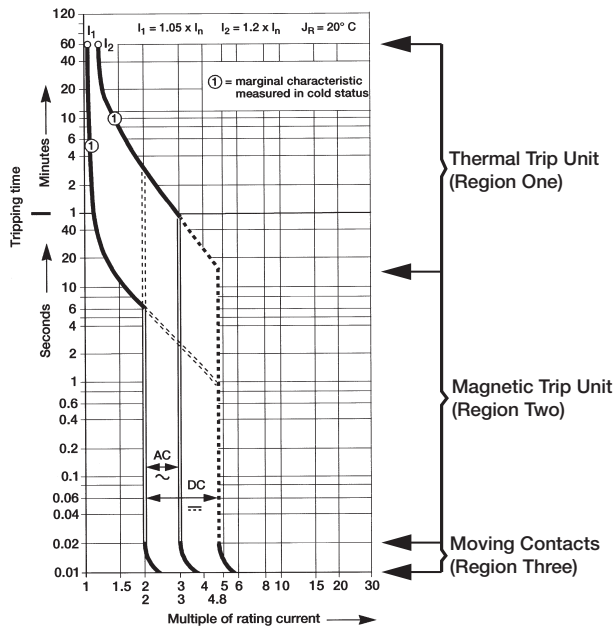

# Circuit breaker current limitation

## Current limiting definitions

All ABB miniature circuit breakers are UL tested and certified as current limiting protective devices. Current limiting circuit breakers provide a higher level of circuit protection than typical zero point external breakers.

## UL AC 60 Hz cycle

UL defines an AC cycle as the potential energy of the wave form traveling from zero-to-positive amplitude, positive-to-zero amplitude, zero-to-negative amplitude, negative-to-zero amplitude 60 times in one second. One cycle is completed every 16.6 milliseconds.

## UL breaker current limiting

UL defines breaker current limitation as a breaker that interrupts and isolates a fault in less than  $\frac{1}{2}$  of an AC cycle.  $\frac{1}{2}$  a cycle is completed in 8.3 milliseconds.

## NEC240.2 current limiting

A device that, when interrupting current in its current-limiting range, reduces the current flowing in the faulted circuit to a magnitude substantially less than that obtainable in the same circuit if the device were replaced with a solid conductor having comparable impedance.

## IEC 60947-2 current limiting circuit breaker

A circuit breaker with sufficiently short trip time to prevent the short-circuit current from reaching the peak value which would otherwise be reached.

## ABB current limiting breakers

ABB current limiting breakers can interrupt and isolate a fault in  $\frac{1}{8}$  of an AC cycle. The breaker fault interruption is completed in 2.3 to 2.5 milliseconds.

## Zero point extinguishing breakers

A typical zero point extinguishing breaker interrupts a fault and does not isolate the energy. The breaker allows an arc to be present between the open contacts until the AC wave form crosses zero. When the wave form crosses zero, the potential energy is zero and the arc (fault) naturally extinguishes. The arc could be present for up to 8.3 milliseconds.

## Current limiting breakers and electrical networks

### Current Limitation

When a short-circuit condition occurs, the “ideal” current limiting circuit breaker opens before the current waveform can reach its full potential magnitude which occurs at  $\frac{1}{4}$  cycle (4.17ms). ABB’s current limiting breakers can interrupt a fault in about  $\frac{1}{2}$  cycle or 2.3 ms to 2.5 ms. ABB’s current limiting breakers interrupt a short circuit in less than  $\frac{1}{8}$  cycle and limit the amount of current that can reach a circuit. Limiting the available current on the circuit provides additional protection against network, breaker, or bus damage and prevents the tripping of upstream breakers (selective coordination).

### $I^2t$

The true destructive nature of a short circuit is measured by the time it is available combined with the peak value of the short circuit. The  $I^2t$  (Amps Squared over Time) value represents the amount of energy available on a network during a short circuit and is represented by the shaded area on the graph below.

During a short circuit, both magnetic forces and thermal energy combine to damage devices on the electrical network. The level of thermal energy and magnetic forces are directly proportional to the square of the current. The magnetic forces vary as a square of the peak current available and the thermal energy varies as a square of the RMS (root mean square) current available.

ABB’s current limiting breakers will limit the let-through energy to a fraction ( $\frac{1}{100}$ ) of the value that is available from the network. By comparison, a zero crossing breaker would let through approximately 100 times as much destructive energy as the current limiting circuit breaker [  $(100,000A / 10,000A)$  squared – 100X]. ABB’s current limiting breakers limit the short circuit current to a relatively small magnitude in an extremely short time, which dramatically limits a short circuit’s destructive energy.

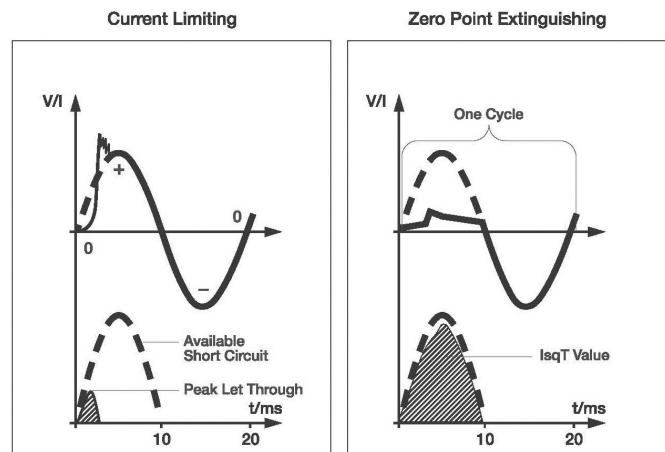

# Circuit breaker current limitation

## Current limiting and zero crossing breakers

During the initial stages of a short circuit, a breaker's contacts open to interrupt the circuit. After the contacts open, an arc forms in the air between the contacts on both the current limiting and zero crossing breaker contacts. What distinguishes a current limiting breaker from a zero crossing breaker is what each breaker does after an arc is formed between the open contacts.

A current limiting breaker "runs" the arc down the breaker arc runner into an arc chute that extinguishes the arc.

A zero crossing breaker does not attempt to extinguish the arc. The breaker is designed to withstand the energy of the arc long enough for the waveform to cross zero. When the wave form crosses zero the potential energy is zero and the arc naturally extinguishes itself.

ABB's current limiting breakers interrupt the arc energy in 2.3 ms to 2.5 ms ( $\frac{1}{8}$  cycle) and a zero crossing breaker allows the arc to be present for up to 8.3 ms ( $\frac{1}{2}$  cycle). A zero crossing breaker will let through 100 times as much energy as an ABB current limiting breaker.

## Current limiting example

The lab test report below details a 20 A S200 series current limiting breaker interrupting a 28 kA fault in 1.7 milliseconds. The total "I Square T" value is 32.0 kA.

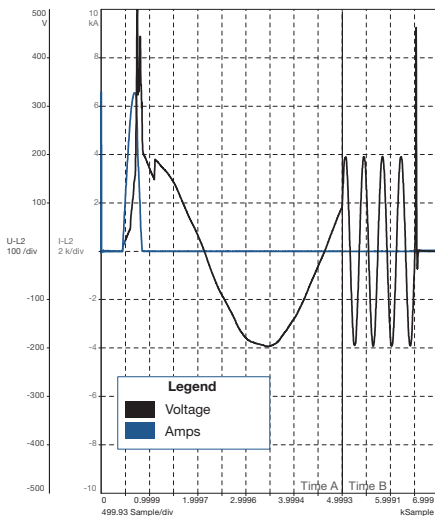
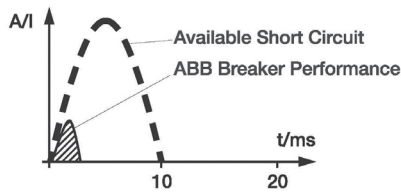

## Zero crossing example

The test report below details a 20 A zero point extinguishing breaker interrupting a 9 kA fault in 9 milliseconds. The total "I Square T" value is 104.0 kA.

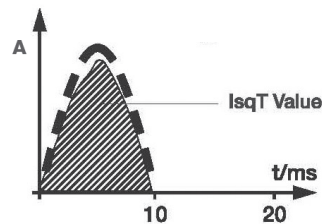
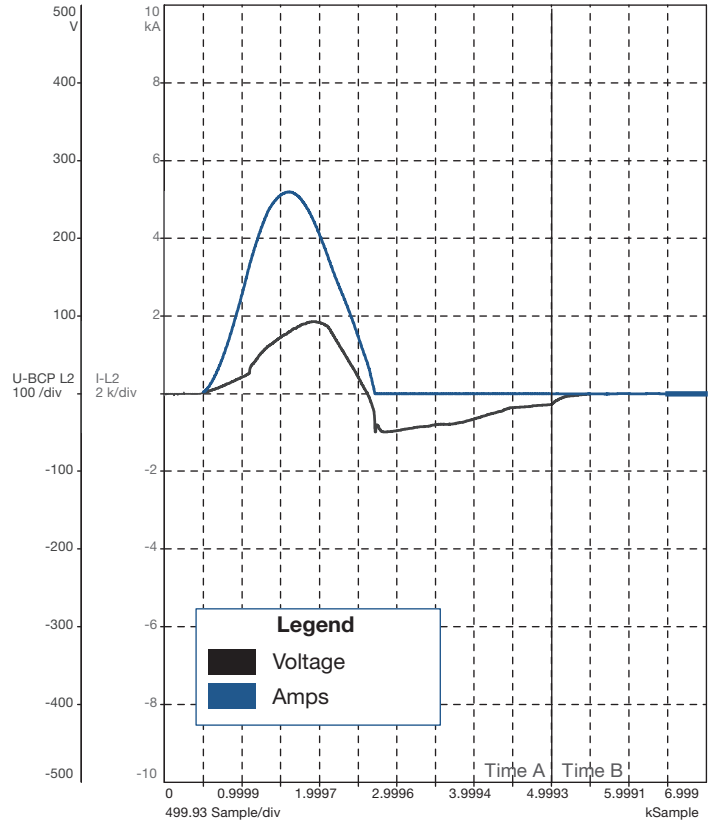

# Selective coordination and series ratings

## Definition of selective coordination

Coordination between the operating characteristics of two or more overcurrent protection devices, so that when an over-current within established limits occurs, the device designated to operate within those limits trips whereas the other devices does not trip.

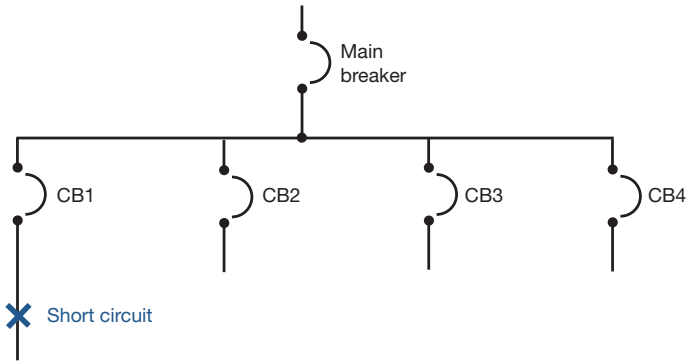

## Example of breaker coordination

When an over-current event occurs at the branch breaker level (CB1), and the event is within the operating characteristics of the breaker, then the branch breaker should interrupt the circuit (open) and the main breaker should remain closed and energized. The chart below gives a graphical representation of a down stream branch breaker (B curve) and a main breaker (A curve) with coordination. The separation between the curves allows the branch breaker to react to the fault and the main breaker remains closed and energized.

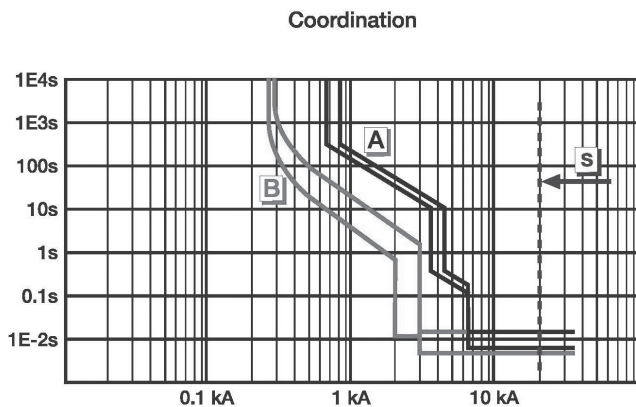

## Example of no breaker coordination

Selective breaker coordination is not achieved when there is an overload event at the branch breaker level (MCB1) and both the branch breaker and main breaker interrupt the circuit (open). When there is no breaker coordination, several circuits lose power that should remain operational during and after the overload event. The chart below gives a graphical representation of a down stream branch breaker (B curve) and a main breaker (A curve) without coordination. There is no separation between the curves. The branch breaker will react to a fault and the main breaker will open and de-energize all circuits down stream.

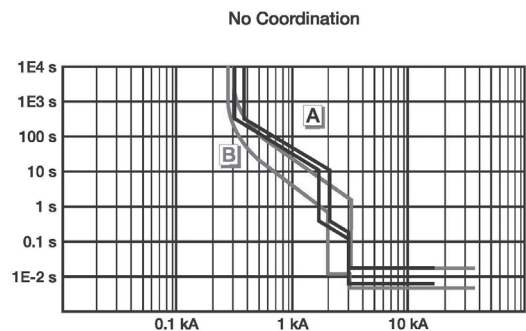

Problems in coordination occur when the branch breaker allows the “I Square T” value of the short circuit to rise to a level that is in the operating range of the upstream main breaker. Proper breaker coordination is easier to achieve with the use of current limiting breakers at the branch level.

## Selective coordination and current limiting breakers

Recent improvements in ABB circuit breaker technology has pushed the performance of breakers to the same level as fuses. The reaction time and tripping characteristics of current limiting breakers are now on par with fuses. This allows ABB to provide a high level of coordination between branch breakers and the main. A current limiting branch breaker will limit the “I Square T” value well below the level of the operating range of the upstream main breaker. ABB’s current limiting branch breakers can coordinate between the main breaker up to 35 kA.

## Selective coordination and zero crossing breakers

Zero crossing breakers do not limit the “I Square T” value. They wait for the wave form to cross zero and allow a high level of let-through energy to pass through the system. The “I Square T” value of a zero crossing breaker is high enough that the main breaker will likely trip during a short circuit. With zero crossing breakers it is extremely difficult to coordinate between branch and main breakers. A typical zero crossing breaker’s coordination level is below 10 kA. There are a few manufacturers that have achieved coordination between a branch zero crossing breaker and the main by slowing the performance (protection) of the main breaker.

# Selective coordination and series ratings

## Selective coordination

Selective coordination is achieved when there is a short circuit on a branch circuit breaker, the branch breaker opens and isolates the fault, and the main breaker remains closed. The rating is usually a value above the “stand alone” interrupting rating of the branch breaker and the “stand alone” rating of the main breaker.

### Example:

65 kA rated main breaker

10 kA rated branch breaker

Coordination between the two breakers up to 35 kA

There can be a short circuit on the branch breaker up to 35 kA where the branch will open (CB1) and the main breaker will remain closed. Although the branch has a 10 kA “stand alone” rating, both the breakers work together to limit the available short circuit to allow the branch (CB1) to isolate the fault.

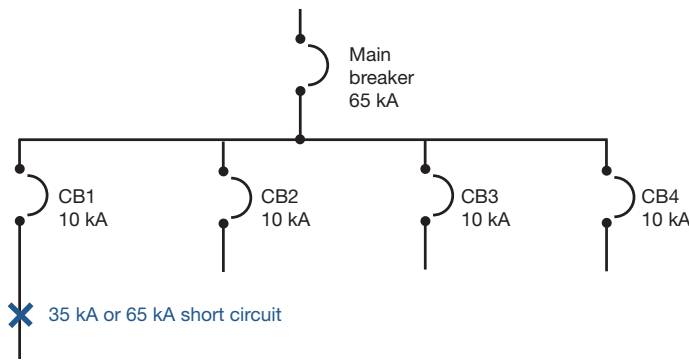

## Series ratings

Series ratings are different from coordination ratings. Unlike coordination ratings where the branch opens and the main remains closed, a series rated combination is one where both the branch and main breakers open and work together to isolate the fault.

The series rating combination of two breakers is equal to the “stand alone” interrupting value of the main breaker. This is a result of the main breaker let-through value being lower than the “stand alone” interrupting value of the branch breaker. During a short circuit the main breaker will limit the energy to a level that is below the “stand alone” value of the branch breaker.

### Example:

65 kA rated main breaker

10 kA rated branch breaker

Series combination rating between the two breakers up to 65 kA

There can be a short circuit on the branch breaker up to 65 kA where the branch will open and the main breaker will open. Although the branch breaker (CB1) has a 10 kA “stand alone” rating the main breaker has a let-through value below 10 kA. If there is a fault up to 65 kA on the network, the main breaker will limit the energy to a value less than the rating of the branch breaker (CB1). Both breakers will trip (no coordination), but the network can safely withstand a fault of 65 kA.

# Miniature circuit breaker cutaway

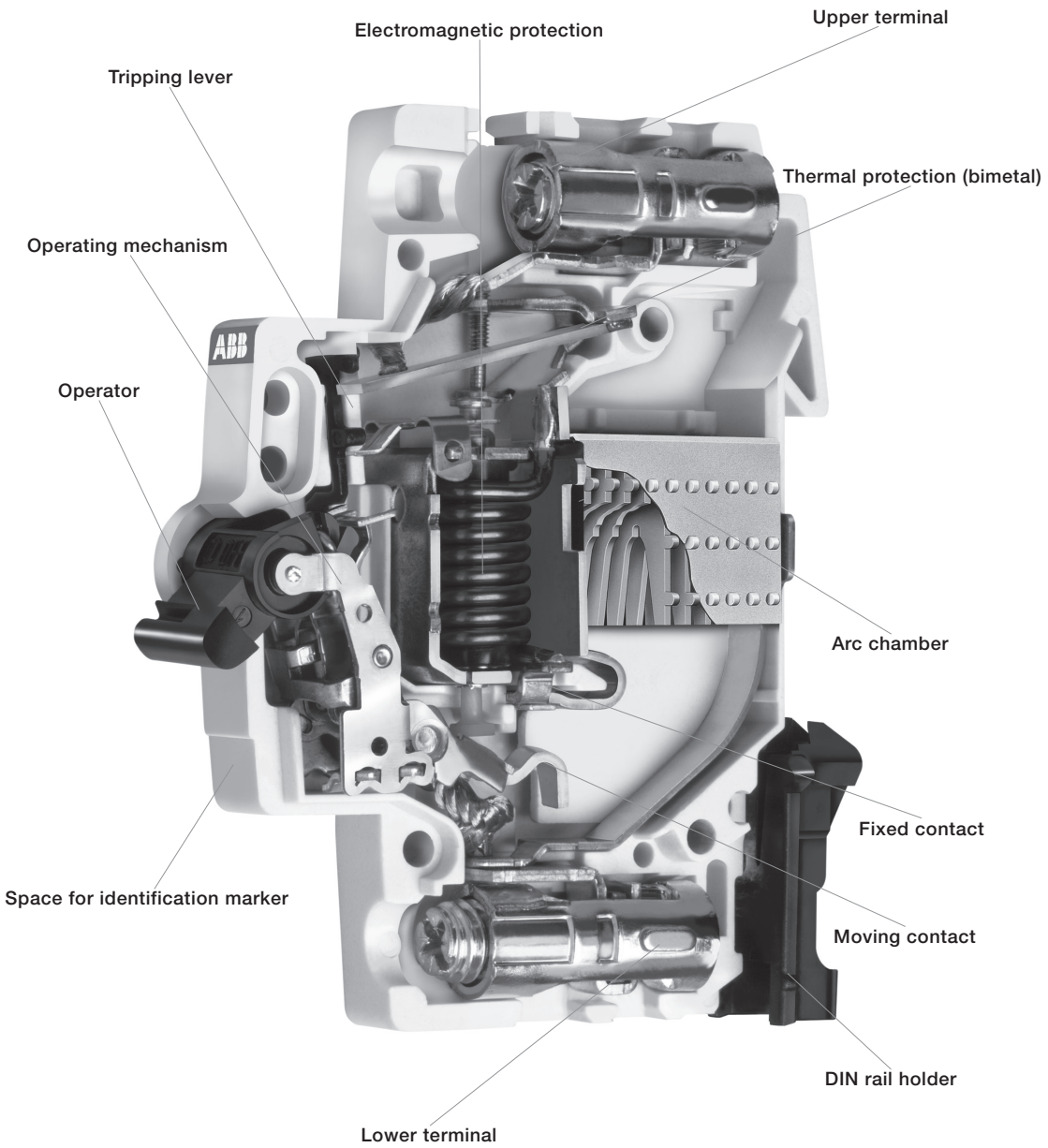



# S800U series

## High performance circuit breakers—UL 489 series



### Description

The S800U high performance MCB offers a compact solution to circuit protection. The S800U devices are DIN rail mounted. The S800U is available with application-specific trip characteristics to provide maximum circuit protection.

The breakers offer thermal-magnetic trip protection according to Z and K characteristics.

For the worldwide market, the breakers carry CSA, IEC, CE and many other agency approvals.

### Features

- Energy limiting
- Fast breaking time (2.3-2.5 ms)
- Wide range of accessories
- DIN rail mounting
- Finger safe terminals
- Multi-function terminals
- Ring tongue compatible
- UL 489 File #E312425

	S800U	S800U-UCZ	S800U-PVS
<b>Amperage</b>	10-100 A	10-80 A	5 A
<b>Voltage</b>	240 VAC	600 VDC	1000 VDC
<b>Poles</b>	1, 2, 3, 4	4 in series	4 in series
<b>Trip curves</b>	Z, K	Z	PVS
<b>Short circuit interrupt rating</b>	30/50 kA (single-/multi-pole)	10 kA	3 kA
<b>Auxiliary contacts</b>	Yes	—	—
<b>Bell alarm</b>	Yes	—	—
<b>Shunt trip</b>	Yes	—	—
<b>Undervoltage release</b>	Yes	—	—
<b>Terminals</b>	Compression/ring tongue	Compression	Compression



# S800U-K, 240 VAC

## Branch circuit protection—UL 489

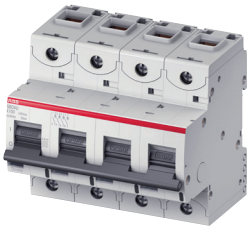
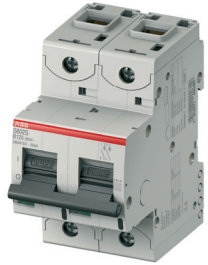

Number of poles	Rated current		Number of poles	Rated current	
	$I_n$ A	Catalog number		$I_n$ A	Catalog number
1	10	S801U-K10	3	10	S803U-K10
	15	S801U-K15		15	S803U-K15
	20	S801U-K20		20	S803U-K20
	25	S801U-K25		25	S803U-K25
	30	S801U-K30		30	S803U-K30
	40	S801U-K40		40	S803U-K40
	50	S801U-K50		50	S803U-K50
	60	S801U-K60		60	S803U-K60
	70	S801U-K70		70	S803U-K70
	80	S801U-K80		80	S803U-K80
2	10	S802U-K10	4	10	S804U-K10
	15	S802U-K15		15	S804U-K15
	20	S802U-K20		20	S804U-K20
	25	S802U-K25		25	S804U-K25
	30	S802U-K30		30	S804U-K30
	40	S802U-K40		40	S804U-K40
	50	S802U-K50		50	S804U-K50
	60	S802U-K60		60	S804U-K60
	70	S802U-K70		70	S804U-K70
	80	S802U-K80		80	S804U-K80
	90	S802U-K90		90	S804U-K90
	100	S802U-K100		100	S804U-K100

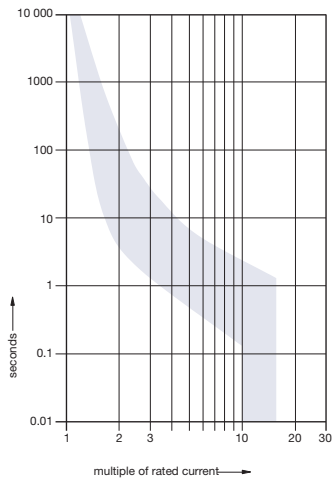

# S800U-Z, 240 VAC

## Branch circuit protection—UL 489

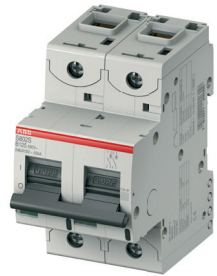

Number of poles	Rated current		Number of poles	Rated current	
	$I_n$ A	Catalog number		$I_n$ A	Catalog number
1	10	S801U-Z10	3	10	S803U-Z10
	15	S801U-Z15		15	S803U-Z15
	20	S801U-Z20		20	S803U-Z20
	25	S801U-Z25		25	S803U-Z25
	30	S801U-Z30		30	S803U-Z30
	40	S801U-Z40		40	S803U-Z40
	50	S801U-Z50		50	S803U-Z50
	60	S801U-Z60		60	S803U-Z60
	70	S801U-Z70		70	S803U-Z70
	80	S801U-Z80		80	S803U-Z80
	90	S801U-Z90		90	S803U-Z90
2	10	S802U-Z10	4	10	S804U-Z10
	15	S802U-Z15		15	S804U-Z15
	20	S802U-Z20		20	S804U-Z20
	25	S802U-Z25		25	S804U-Z25
	30	S802U-Z30		30	S804U-Z30
	40	S802U-Z40		40	S804U-Z40
	50	S802U-Z50		50	S804U-Z50
	60	S802U-Z60		60	S804U-Z60
	70	S802U-Z70		70	S804U-Z70
	80	S802U-Z80		80	S804U-Z80
	90	S802U-Z90		90	S804U-Z90
	100	S802U-Z100		100	S804U-Z100

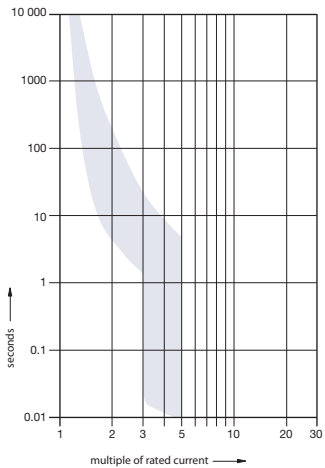

# S804U-PVS5

The S804U-PVS5 is for GFDI applications (Ground-Fault Detector Interrupter) in photovoltaic systems. In case of a ground fault, the breaker will trip and the PV generator will not be damaged. The breaker is tested acc. to UL 489B for 1000VDC.

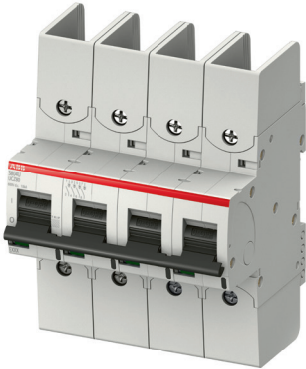

## Technical specifications

Standard		UL 489B
Characteristic		PV-S
Rated current $I_n$	[A]	5
Rated voltage $U_n$	[V]	1000 DC
No. of poles		4
Short-circuit current rating acc. to UL 489B	[kA]	3
Connections 5 A		
Single conductor per terminal – copper only, 75C wire		14 AWG – 2 AWG Cu, Solid or stranded
Tightening torque	[Nm]	3.5 (31 in.lb)
Protection category		IP40 (actuating end only)
Mounting position		Any
Contacts		Cadmium-free
Reference temperature for tripping characteristic	50 °C	
Ambient temperature	[°C]	-25...+60
Storage temperature	[°C]	-40...+70
Approval		cULus File #E351317

## Ordering information

Rated current (A)	Catalog number
5	S804U-PVS5

# S804U-PVS5

## Tested and listed wirings

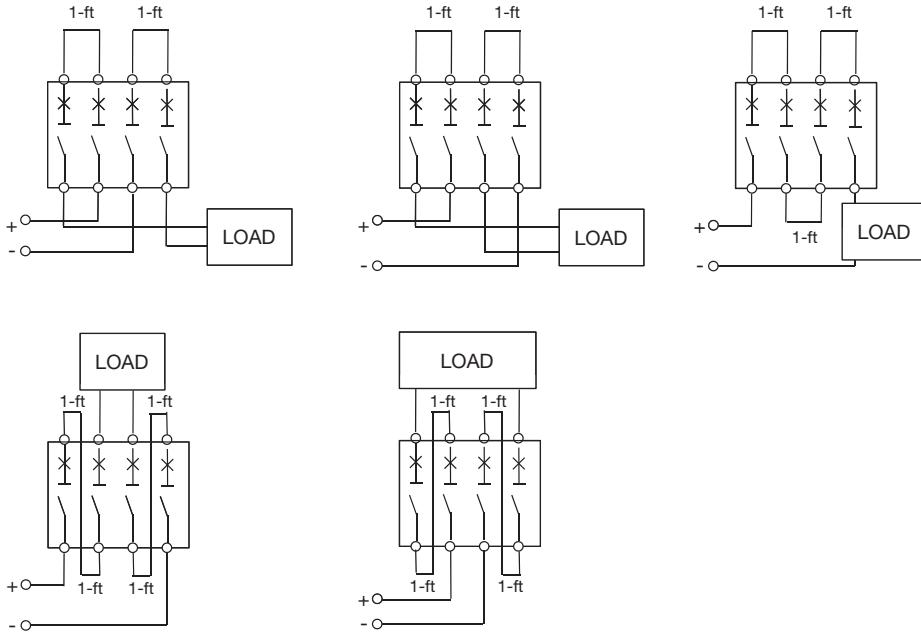

## Trip curve for S804U-PVS5

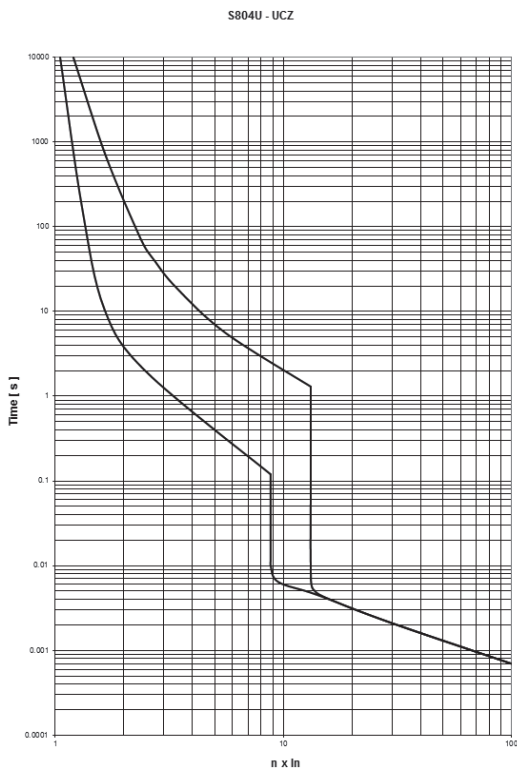

## Dimension S804U-PVS5

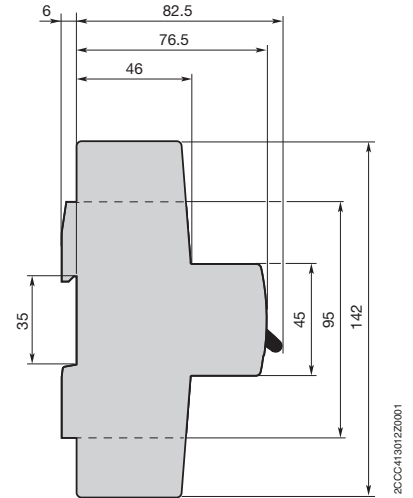
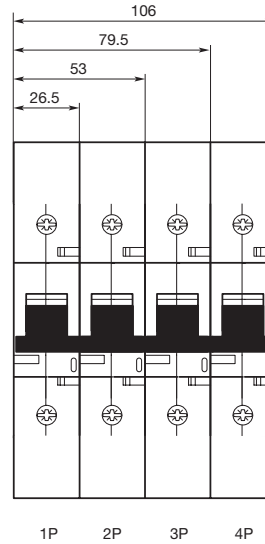

## Tripping behavior acc. to UL 489

Thermal release:  $1.13 - 1.30 \times I_n$

Magnetic release:  $6 \times I_n$

# S804U-UCZ

This breaker is specially designed for networks up to 600 VDC, i.e., a data center. It is available as 4-pole version with a short-circuit current rating of 10 kA acc. to UL 489.

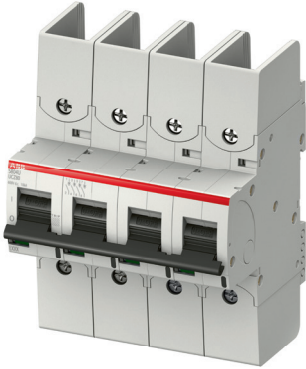

## Technical specifications

Standard		UL 489
Characteristic		Z
Rated current $I_n$	[A]	10–80
Rated voltage $U_n$	[V]	600 DC
No. of poles		4
Short-circuit current rating acc. to UL 489	[kA]	10
Tightening torque	[Nm]	3.5 (31 in.lb)
Protection category		IP40 (actuating end only)
Mounting position		Any
Contacts		Cadmium-free
Reference temperature for tripping characteristic		25 °C
Ambient temperature	[°C]	–25...+60
Storage temperature	[°C]	–40...+70
Approval		cULus File #E311

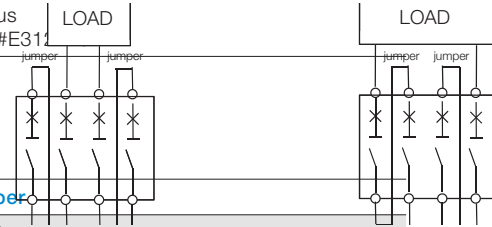

## Ordering information

Rated current (A)	Catalog number
10	S804U-UCZ10
15	S804U-UCZ15
20	S804U-UCZ20
25	S804U-UCZ25
30	S804U-UCZ30
40	S804U-UCZ40
50	S804U-UCZ50
60	S804U-UCZ60
70	S804U-UCZ70
80	S804U-UCZ80

# S804U-UCZ

## Tested and listed wirings

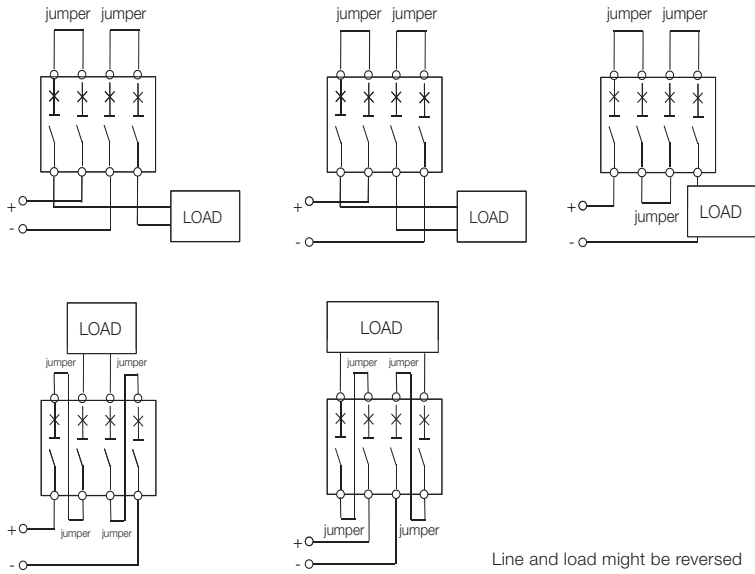

Ampere rating (A)	10–32	40–63	70–80
Conductor type	Single conductor per terminal – copper only, 60/75 °C wire	Single conductor per terminal – copper only, 60 °C wire only	Single conductor per terminal – copper only, 60 °C wire only
AWG, wire range	14 AWG–2 AWG Cu, solid or stranded	1/0 AWG–8 AWG Cu, solid or stranded	1/0 AWG–8 AWG Cu, solid or stranded
Jumper length (ft)	1	1	2
Jumper length (cm)	30.5	30.5	61

## Trip curves for S804U-UCZ

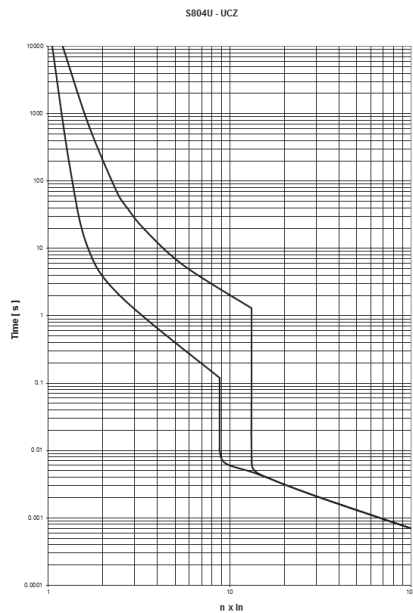

## Dimension of S804U-UCZ

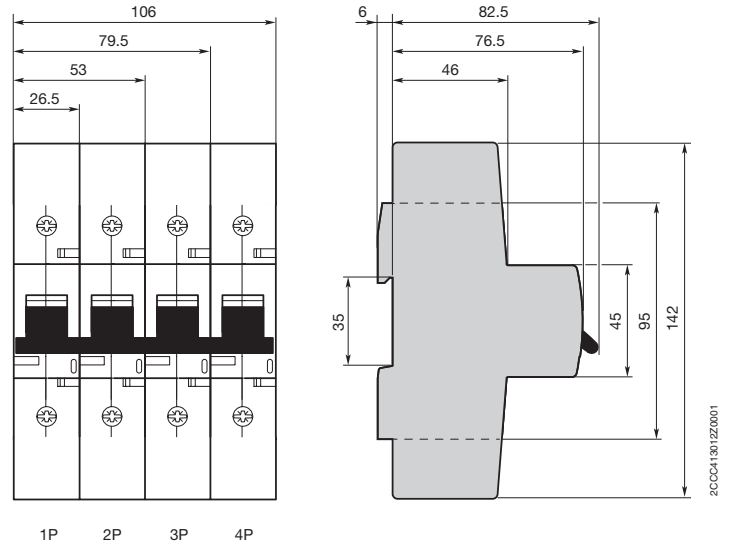

## Tripping behavior acc. to UL489

Thermal tripping:  $1.00 \dots 1.35 \times I_e$   
 Electromagnetic tripping  $11 \times I_e \pm 20\%$

# S803W-SCL-SR UL Short circuit current limiter, self-resetting

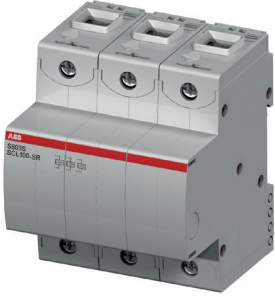

## UL version short circuit current limiter, self-resetting, 3 pole

Description	Catalog number
32A Self-resetting current limiter	S803W-SCL32-SR
63A Self resetting current limiter	S803W-SCL63-SR
100A Self resetting current limiter	S803W-SCL100-SR

## Technical specifications

Rated voltage	600 VAC per UL508
Short circuit current rating according to UL508, CSA 22.2	480 VAC 50/60 Hz, 65 kA 600 VAC 50/60 Hz, 65 kA

## Approved combinations with motor starter

Downstream devices		Upstream devices	
Rated current $I_n$ [A]	32	63	100
<b>MS/MO325</b>			
0.1-2.5	•	•	•
4	•	•	•
6.3	•	•	•
9	•	•	•
12.5	•	•	•
16	•	•	•
20		•	•
25		•	•
<b>MS/MO132</b>			
0.1-2.5	•	•	
4	•	•	
6.3	•	•	•
10	•	•	•
16	•	•	•
20		•	•
25		•	•
32		•	•

-Combinations with S500-K and S500-KM on request.

•Applies for all voltages according to the table below

## Rated ultimate short-circuit breaking capacity

Short-circuit rating according to UL 508, CSA 22.2		
(AC) 50/60 Hz 480 V	[kA]	65
(AC) 50/60 Hz 600 V	[kA]	65
<b><math>I_{cu} = I_{cs}</math> according to IEC 60947-2</b>		
(AC) 50/60 Hz 240/415 V	[kA]	100
(AC) 50/60 Hz 254/440 V	[kA]	100
(AC) 50/60 Hz 277/480 V	[kA]	65
(AC) 50/60 Hz 289/500 V	[kA]	65
(AC) 50/60 Hz 346/600 V	[kA]	65
(AC) 50/60 Hz 400/690 V	[kA]	50



# Approximate dimensions

## S803W-SCL-SR UL508 Short circuit current limiter, self-resetting

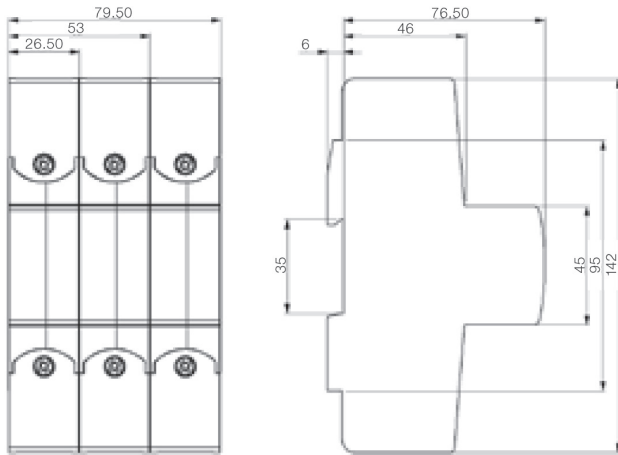

Minimum cable length between S803W-SCL-SR and downstream devices  
(Connection has to be short-circuit proofed acc. to IEC 61439-1)

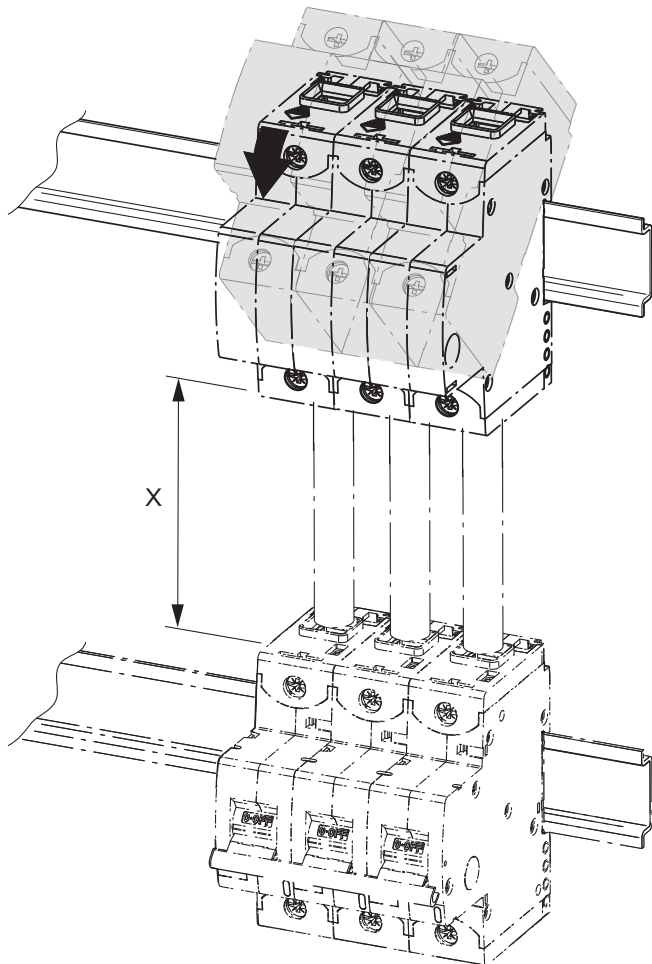

MS/M0325		
MS/M0132		
S800		
S800-SCL-SR	min. length X	min. cross section
32 A	80 mm	6 mm <sup>2</sup>
63 A	80 mm	16 mm <sup>2</sup>
100/125 A	250 mm	35 mm <sup>2</sup>

# S800W-RSU Remote switching unit

## UL 489



**S800W-RSU**  
(breaker is not included)



**S800-RSU-CP**

### Remote switching unit

Description	Catalog number
Remote switching unit	S800W-RSU

### S800-RSU cable including plug

Description	Catalog number
3 meter cable 0.5 mm <sup>2</sup> (AWG20) including 10-pole Micro-Fit 3.0™ plug	S800-RSU-CP

### Key features

- The remote switching unit S800W-RSU has a brushless high precision DC motor to ensure fast remote control operation
- Low power consumption
- Short switching times
- The S800W-RSU is mounted on any multi-pole S800 high-performance MCB
- Installation and wiring can be field installable
- The connection is done by a 10-pole Micro-Fit 3.0™ (not included in delivery)
- The S800W-RSU can be operated by a standard pushbutton or drive by a PLC

### Switching times

- OFF -> ON <<500ms  
from signal to contact closing
- ON -> OFF <<250ms  
from signal to contact opening
- TRIP -> OFF -> ON <<1500ms  
from signal to contact closing

For different requirements, please contact your local ABB partner

### Safety intelligence

- Inputs are deactivated when detecting manual use
- All outputs become active when spindle is rotated more than 360 degrees
- S800W-RSU is locked for five minutes after three switching attempts leading to a trip
- Manual switch off possible for three- and four-pole devices

### Technical specifications

Operational voltage	24 VDC
Current consumption I <sub>ms</sub>	2, 5
Standby current I <sub>Standby</sub>	< 50 mA
Switching time OFF-ON	< 500 msec
Switching time ON-OFF	<250 msec
Ambient operation temperature	-25...+70 °C
Number of switching operations	10.000
Maximum cable lengths (AWG20/0.5mm <sup>2</sup> )	10 m
Degree of protection (mounted)	IP2
Weight	0.661387 lb.
Connection	10-pole Micro-Fit 3.0™

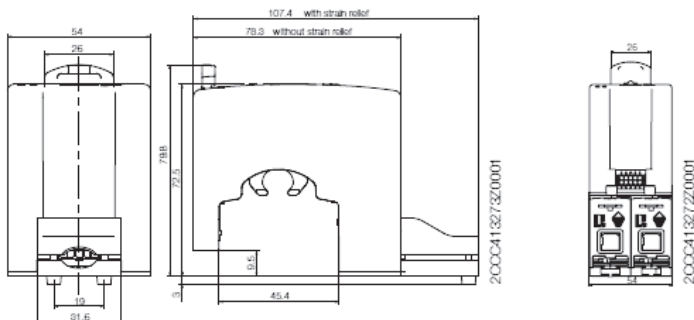

Approximate dimensions

# Accessories

## S800U



S800-SOR

### Shunt trip

For remote tripping of breaker, a shunt trip device can be added to the MCB. The device opens the breaker after control voltage is applied.

Description (for field mounting, left side)	Catalog number
Shunt operation release 24 VAC/DC	S800-SOR24
Shunt operation release 48...130 VAC/DC	S800-SOR130
Shunt operation release 110...250 VAC/DC	S800-SOR250



S800-UVR

### Undervoltage release

When control voltage drops below approximately 50 percent of rated voltage, the UVR opens the breaker. The breaker cannot be operated unless proper control voltage is first applied to the UVR coil.

Description	Catalog number
Undervoltage release 24...36 VAC/DC	S800-UVR36
Undervoltage release 48...60 VAC/DC	S800-UVR60
Undervoltage release 110...130 VAC/DC	S800-UVR130
Undervoltage release 220...250 VAC/DC	S800-UVR250



S800-AUX

### Auxiliary contacts

The auxiliary contacts will signal whether the breaker is in the ON or OFF position.

Description	Catalog number
Auxiliary contact	S800-AUX



S800-AUX/ALT

### Bell alarm

The bell alarm includes a set of contacts that will only signal when the breaker has tripped. Typically, the contacts would be connected to an alarm or bell to signal the operator that an overcurrent trip has occurred. The bell alarm also includes a test button for testing the alarm contacts without opening the breaker.

Description	Catalog number
Bell alarm	S800-AUX/ALT



S800-RT2125

### Ring tongue adaptor

Description	Catalog number
Ring terminal cable connection, 40-125 A	S800-RT2125

# Accessories S800U

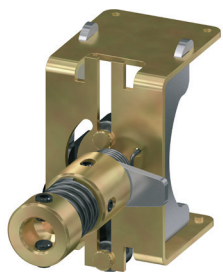

S800-RD

## Rotary operating mechanism

Allows "through the door" operation.

Description	Catalog number
Handle mechanism	S800-RD

Description	Catalog number
Gray rotary handle	S800-RHE-H



S800-RHE-H

Description	Catalog number
Red rotary handle	S800-RHE-EM

## UL locking device

Description	Catalog number
Shaft extension	S800-RHE-S



S800-RHE-EM

Description	Catalog number
Padlock not included	S800U-PLL



S800-RHE-S



S800U-PLL



# Technical specifications

## S800U

### Typical internal resistances and power losses at 25 °C ambient temperature

Rated current $I_n$ [A]	Internal resistance $R_i$ [mΩ] K, Z	Power loss $P_v$ [W] K, Z
10	15.2	1.5
15	12.1	2.7
20	8.7	3.5
25	6.8	4.2
30	3.1	2.8
40	2.3	3.7
50	1.7	4.3
60	1.6	5.8
70	1.0	6.4
80	1.0	6.4
90	0.8	6.5
100	0.8	8.3

### Influence of ambient temperature

Devices mounted singly (specifications in A)

#### S800U-K, -Z

$I_n$ [A]	10 °C	15 °C	20 °C	25 °C	30 °C	35 °C	40 °C	45 °C	50 °C	55 °C	60 °C
10	10.9	10.7	10.4	10.0	9.6	9.3	9.0	8.7	8.4	8.0	7.6
15	16.5	16.0	15.6	15.0	14.4	14.0	13.5	13.0	12.6	12.0	11.4
20	22.0	21.4	20.8	20.0	19.2	18.6	18.0	17.4	16.8	16.0	15.2
25	27.5	26.8	26.0	25.0	24.0	23.3	22.5	21.8	21.0	20.0	19.0
30	33.1	32.1	31.2	30.0	28.8	27.9	27.0	26.1	25.2	24.0	22.9
40	44.0	42.8	41.6	40.0	38.4	37.2	36.0	34.8	33.6	32.0	30.9
50	55.1	53.5	52.0	50.0	48.0	46.5	45.0	43.5	42.0	40.0	38.3
60	66.2	64.2	62.4	60.0	57.6	55.8	54.0	52.2	50.4	48.0	46.0
70	76.9	74.9	72.8	70.0	67.2	65.1	63.0	60.9	58.8	56.0	53.4
80	88.0	85.6	83.2	80.0	76.8	74.4	72.0	69.6	67.1	64.0	61.6
90	99.1	96.3	93.6	90.0	86.4	83.7	81.0	78.3	75.6	72.0	69.5
100	110.5	107.0	104.0	100.0	96.0	93.0	90.0	87.0	83.8	80.0	77.8

# Technical specifications

## S800U-UL

### Auxiliary contact S800-AUX

	S800-AUX
Usage category	AC15 400/2 A-UL AC15 240/ -UL DC13 250/0.55 A125 V/1.1A-IEC DC13 125 V/1.1A DC13 60 V/2A DC13 24 V/4A
Continuous thermal current $I_n$	6 A
Rated insulation voltage $U_i$	690 V
Number of contacts	2
Surge $U_{test}$ (1.2/50 $\mu$ s)	6 kV
Degree of protection	3
Function of contact	Changeover contacts
Connection CU	1 x 2.5 mm <sup>2</sup> 2 x 1.5 mm <sup>2</sup>
Tightening torque	1 Nm
Ensured contacts during shake test acc. to IEC 68-2-6	5g, 20 frequency cycle at 24 VAC/DC, 5mA brief interrupt <10 ms
AC/DC supply	any EN 60715
Mounting on DIN top hat rail	EN 60715 IP20
Type of protection	IP20
Permissible ambient temperature for operations	-25...+60 °C; -13 °F...140 °F
Storage temperature	-40...+70 °C; -40 °F...158 °F
Mechanical device service life	6000 switching cycles
$I_{cu}$ with S450E	1000 A
Resistance to vibration	IEC 60068-2-27; IEC 60068-2; EN 61373 Cat. 1/class B

### Undervoltage release S800-UVR

	S800-UVR36	S800-UVR60	S800-UVR130	S800-UVR250
Rated voltage $U_e$	24...36 VAC/DC	48...60 VAC/DC	110...130 VAC/DC	220...250 VAC/DC
Operating range			35...70% $U_e$	
Operating opening			85% $U_e$	
Operating closing			690 V	
Rated insulation voltage $U_i$				
Coil pull in consumption	1 W, 14 vA	1 W, 25 vA	1 W, 41 vA	1 W, 91 vA
Rated frequency			DC; 50/60 Hz	
Protection degree			3	
Connection Cu			1...35 cable	
Tightening torque			min. 3/max. 4 Nm	
AC/DC supply			Any	
DIN top hat rail			EN 60715	
Type of protection			IP20 IP40 (only actuation side)	
Permissible ambient temperature of operations			-25...+60 °C; -13 °F...140 °F	
Storage temperature			-40...+70 °C; -40 °F...158 °F	
S800-UVR36				IEC 60068-2-27; IEC 60068-2; EN61373 Cat. 1/class B



# Technical specifications

## S800U-UL

### Combined auxiliary and bell alarm

Usage category	AC15 400/2 A-UL AC15 240/6A-UL DC13 250/0.55 A125 V/1.1A-IEC DC13 125 V/1.1A-IEC DC13 60 V/2A DC13 24 V/4A
Continuous thermal current $I_n$	6 A
Rated insulation voltage $U_i$	690 V
Number of contacts	2 (1x AUX, 1 x AUX/ALT)
Surge $U_{test}$ (1.2/50 $\mu$ s)	6 kV
Degree of protection	3
Function of contact	Changeover contacts
Connection CU	1 x 2.5 mm <sup>2</sup> 2 x 1.5 mm <sup>2</sup>
Tightening torque	1 Nm
Ensured contacts during shake test acc. to IEC 68-2-6	5g, 20 frequency cycle 5...150...5 Hz at 24 VAC/DC, 5 mA brief interrupt <10 ms
AC/DC supply	any EN 60715
Mounting on DIN top hat rail	EN 60715
Type of protection	IP20
Permissible ambient temperature for operations	-25...+60 °C; -13 °F..140 °F
Storage temperature	-40...+70 °C; -40 °F..150 °F
Mechanical device service life	6000 switching cycles
$I_{cu}$ with S450E	1000 A
Resistance to vibration	IEC 60068-2-27; IEC 60068-2; EN 61373 Cat. 1/class B

### Shunt operation release – S800-SOR

	S800-SOR24	S800-SOR130	S800-SOR250	S800-SOR400
Rated voltage $U_o$	24 VAC/DC	48...130 VAC/DC	110...250 VAC/DC	220...250 VAC/DC
Operating range			70...110% $U_e$	
Rated insulation voltage $U_i$			690 V	
Coil pull in consumption	19.2 W/vA		On request	
Rated frequency			DC; 50/60 Hz	
Protection degree			3	
Connection Cu			1...35 AWG	
Tightening torque			min. 3/max. 4 Nm	
AC/DC supply			Any	
DIN top hat rail			EN 60715	
Type of protection			IP20 IP40 (only actuation side)	
Permissible ambient temperature of operations			-25...+60 °C; -13 °F..140 °F	
Storage temperature			-40...+70 °C; -40 °F..158 °F	
S800-UVR36		IEC 60068-2-27; IEC 60068-2; EN61373 Cat. 1/class B		

# Approximate dimensions S800U-UL

## S800U

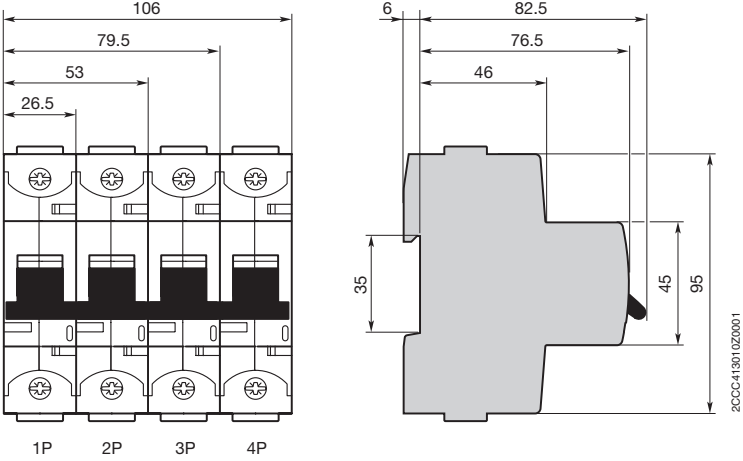

20CC413010Z0001

## S800-SOR and S800-UVR

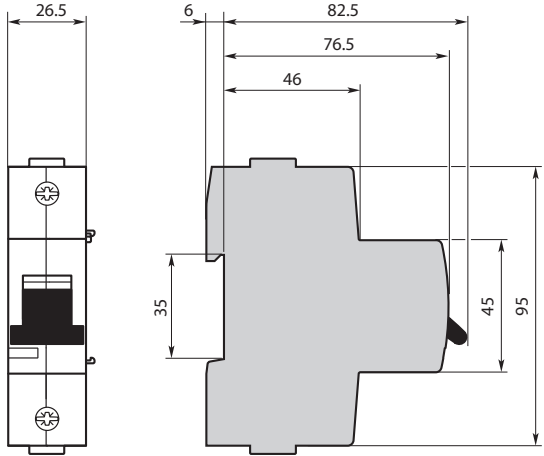

# Approximate dimensions S800U-UL

## S800-AUX

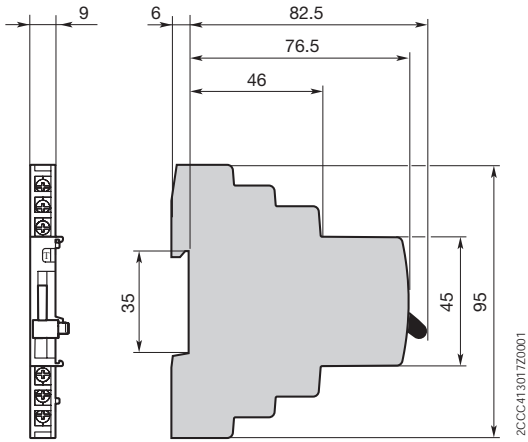

## S800-AUX/ALT

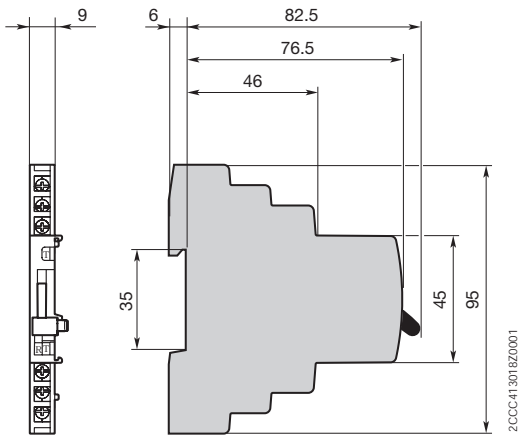

## S800-RD AND S800-RHE

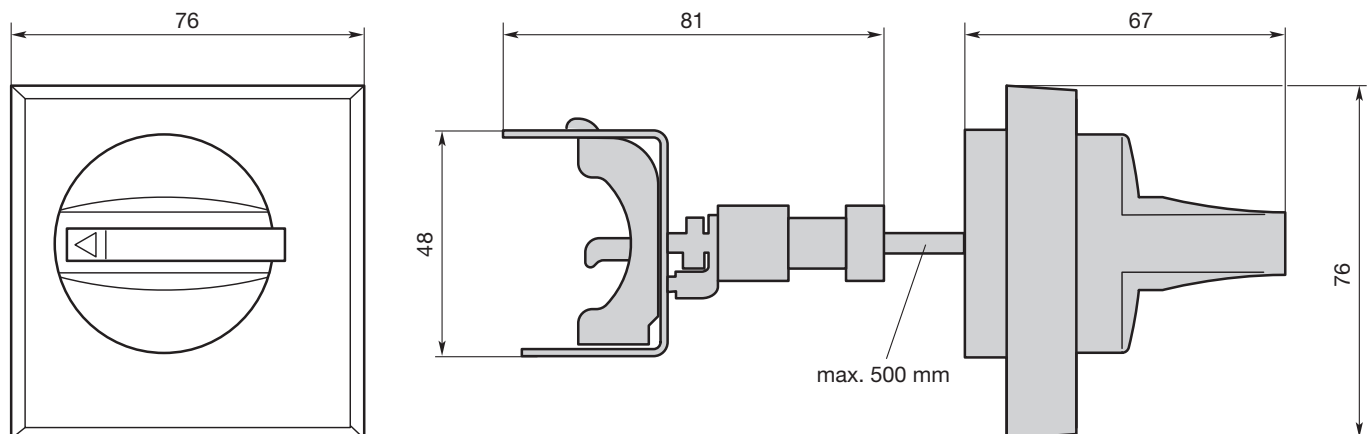

# S500 series

## UL 1077

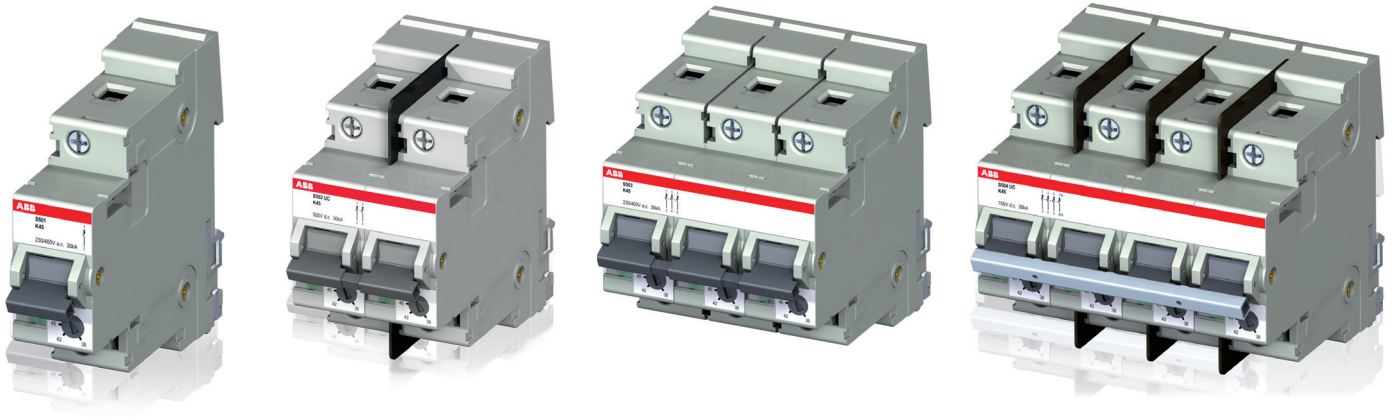

### Description

The S500 high performance MCB offers a compact solution to circuit protection. The S500 devices are UL tested current limiting and DIN rail mounted. The S500 is available with application-specific trip characteristics to provide maximum circuit protection.

The breakers offer thermal-magnetic trip protection according to B and K characteristics.

For the worldwide market, the breakers carry CSA, IEC, CE and many other agency approvals.

### Features

- High breaking capacity
- Fast breaking time (2.3 - 2.5 ms)
- Adjustable trip unit
- DIN rail mounting
- Finger safe terminals
- Multi-functional terminals
- Wide range of accessories
- UL 1077 recognized 600 VAC and 600 VDC versions
- UL1077 AC adjustable K
- UL1077 DC adjustable B, K
- UL File #E167556
- IEC #E60497-2

	S500	S500UC
<b>Amperage</b>	0.1-45 A	0.1-63 A
<b>Voltage</b>	600Y/347 VAC	1 pole 250 VDC 2 pole 500 VDC 3 pole 600 VDC 4 pole 600 VDC
<b>Poles</b>	1, 2, 3	1, 2, 3, 4
<b>Trip characteristics</b>	K	B, K
<b>Interrupting ratings</b>	Up to 30 kA: UL 1077 Up to 30 kA: CSA C22.2	30 kA: UL 1077 30 kA: CSA C22.2
<b>Auxilliary contacts</b>	Yes	Yes
<b>Bell alarm</b>	Yes	Yes
<b>Shunt trip</b>	No	No
<b>Undervoltage release</b>	No	No
<b>Busbar</b>	Yes	Yes

# S500-K

## Supplemental protectors—UL 1077, CSA 22.2, IEC

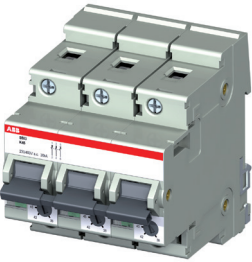
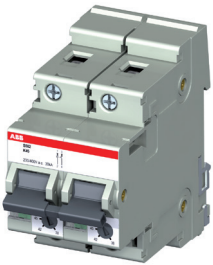

Number of poles	Rated current		Number of poles	Rated current	
	$I_n$ A	Catalog number		$I_n$ A	Catalog number
1	0.1-0.15	S501-K0.15	3	0.1-0.15	S503-K0.15
	0.14-0.21	S501-K0.21		0.14-0.21	S503-K0.21
	0.2-0.3	S501-K0.3		0.2-0.3	S503-K0.3
	0.28-0.42	S501-K0.42		0.28-0.42	S503-K0.42
	0.38-0.58	S501-K0.58		0.38-0.58	S503-K0.58
	0.53-0.8	S501-K0.8		0.53-0.8	S503-K0.8
	0.73-1.1	S501-K1.1		0.73-1.1	S503-K1.1
	1-1.5	S501-K1.5		1-1.5	S503-K1.5
	1.4-2.1	S501-K2.1		1.4-2.1	S503-K2.1
	2-3	S501-K3		2-3	S503-K3
	2.8-4.2	S501-K4.2		2.8-4.2	S503-K4.2
	3.8-5.8	S501-K5.8		3.8-5.8	S503-K5.8
	5.3-8	S501-K8		5.3-8	S503-K8
	7.3-11	S501-K11		7.3-11	S503-K11
	10-15	S501-K15		10-15	S503-K15
	14-20	S501-K20		14-20	S503-K20
	18-26	S501-K26		18-26	S503-K26
	23-32	S501-K32		23-32	S503-K32
	29-37	S501-K37		29-37	S503-K37
	34-41	S501-K41		34-41	S503-K41
38-45	S501-K45	38-45	S503-K45		
2	0.1-0.15	S502-K0.15	3	0.1-0.15	S503-K0.15
	0.14-0.21	S502-K0.21		0.14-0.21	S503-K0.21
	0.2-0.3	S502-K0.3		0.2-0.3	S503-K0.3
	0.28-0.42	S502-K0.42		0.28-0.42	S503-K0.42
	0.38-0.58	S502-K0.58		0.38-0.58	S503-K0.58
	0.53-0.8	S502-K0.8		0.53-0.8	S503-K0.8
	0.73-1.1	S502-K1.1		0.73-1.1	S503-K1.1
	1-1.5	S502-K1.5		1-1.5	S503-K1.5
	1.4-2.1	S502-K2.1		1.4-2.1	S503-K2.1
	2-3	S502-K3		2-3	S503-K3
	2.8-4.2	S502-K4.2		2.8-4.2	S503-K4.2
	3.8-5.8	S502-K5.8		3.8-5.8	S503-K5.8
	5.3-8	S502-K8		5.3-8	S503-K8
	7.3-11	S502-K11		7.3-11	S503-K11
	10-15	S502-K15		10-15	S503-K15
	14-20	S502-K20		14-20	S503-K20
	18-26	S502-K26		18-26	S503-K26
	23-32	S502-K32		23-32	S503-K32
	29-37	S502-K37		29-37	S503-K37
	34-41	S502-K41		34-41	S503-K41
38-45	S502-K45	38-45	S503-K45		

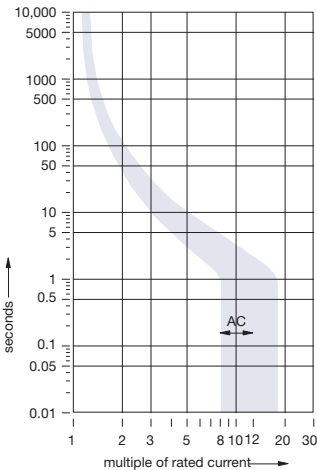

# S500UC-B

## Supplemental protectors—UL 1077, CSA 22.2, IEC

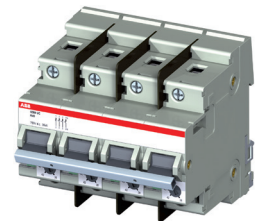
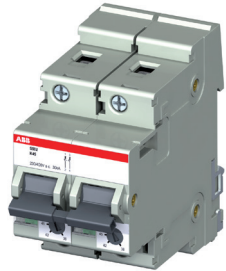

Number of poles	Rated current		Number of poles	Rated current	
	$I_n$ A	Catalog number		$I_n$ A	Catalog number
1	6	S501UC-B6	3	6	S503UC-B6
	10	S501UC-B10		10	S503UC-B10
	13	S501UC-B13		13	S503UC-B13
	16	S501UC-B16		16	S503UC-B16
	20	S501UC-B20		20	S503UC-B20
	25	S501UC-B25		25	S503UC-B25
	32	S501UC-B32		32	S503UC-B32
	40	S501UC-B40		40	S503UC-B40
	50	S501UC-B50		50	S503UC-B50
2	63	S501UC-B63	4	63	S503UC-B63
	6	S502UC-B6		6	S504UC-B6
	10	S502UC-B10		10	S504UC-B10
	13	S502UC-B13		13	S504UC-B13
	16	S502UC-B16		16	S504UC-B16
	20	S502UC-B20		20	S504UC-B20
	25	S502UC-B25		25	S504UC-B25
	32	S502UC-B32		32	S504UC-B32
	40	S502UC-B40		40	S504UC-B40
50	S502UC-B50	50	S504UC-B50		
63	S502UC-B63	63	S504UC-B63		

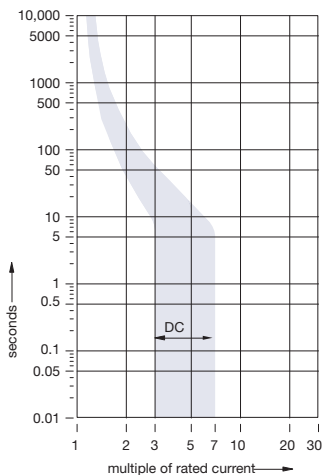



# S500UC-K

## Supplemental protectors — UL 1077, CSA 22.2, IEC

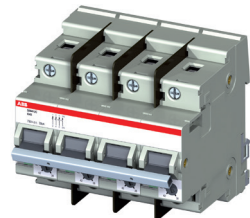
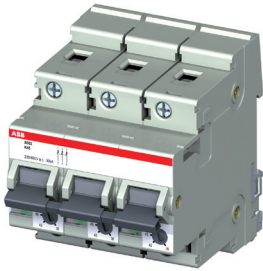
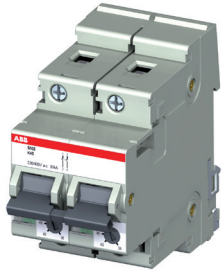

Number of poles	Rated current		Number of poles	Rated current	
	$I_n$ A	Catalog number		$I_n$ A	Catalog number
1	0.1-0.15	S501UC-K0.15	3	0.1-0.15	S503UC-K0.15
	0.14-0.21	S501UC-K0.21		0.14-0.21	S503UC-K0.21
	0.2-0.3	S501UC-K0.3		0.2-0.3	S503UC-K0.3
	0.28-0.42	S501UC-K0.42		0.28-0.42	S503UC-K0.42
	0.38-0.58	S501UC-K0.58		0.38-0.58	S503UC-K0.58
	0.53-0.8	S501UC-K0.8		0.53-0.8	S503UC-K0.8
	0.73-1.1	S501UC-K1.1		0.73-1.1	S503UC-K1.1
	1-1.5	S501UC-K1.5		1-1.5	S503UC-K1.5
	1.4-2.1	S501UC-K2.1		1.4-2.1	S503UC-K2.1
	2-3	S501UC-K3		2-3	S503UC-K3
	2.8-4.2	S501UC-K4.2		2.8-4.2	S503UC-K4.2
	3.8-5.8	S501UC-K5.8		3.8-5.8	S503UC-K5.8
	5.3-8	S501UC-K8		5.3-8	S503UC-K8
	7.3-11	S501UC-K11		7.3-11	S503UC-K11
	10-15	S501UC-K15		10-15	S503UC-K15
	14-20	S501UC-K20		14-20	S503UC-K20
	18-26	S501UC-K26		18-26	S503UC-K26
	23-32	S501UC-K32		23-32	S503UC-K32
29-37	S501UC-K37	29-37	S503UC-K37		
34-41	S501UC-K41	34-41	S503UC-K41		
38-45	S501UC-K45	38-45	S503UC-K45		
2	0.1-0.15	S502UC-K0.15	4	0.1-0.15	S504UC-K0.15
	0.14-0.21	S502UC-K0.21		0.14-0.21	S504UC-K0.21
	0.2-0.3	S502UC-K0.3		0.2-0.3	S504UC-K0.3
	0.28-0.42	S502UC-K0.42		0.28-0.42	S504UC-K0.42
	0.38-0.58	S502UC-K0.58		0.38-0.58	S504UC-K0.58
	0.53-0.8	S502UC-K0.8		0.53-0.8	S504UC-K0.8
	0.73-1.1	S502UC-K1.1		0.73-1.1	S504UC-K1.1
	1-1.5	S502UC-K1.5		1-1.5	S504UC-K1.5
	1.4-2.1	S502UC-K2.1		1.4-2.1	S504UC-K2.1
	2-3	S502UC-K3		2-3	S504UC-K3
	2.8-4.2	S502UC-K4.2		2.8-4.2	S504UC-K4.2
	3.8-5.8	S502UC-K5.8		3.8-5.8	S504UC-K5.8
	5.3-8	S502UC-K8		5.3-8	S504UC-K8
	7.3-11	S502UC-K11		7.3-11	S504UC-K11
	10-15	S502UC-K15		10-15	S504UC-K15
	14-20	S502UC-K20		14-20	S504UC-K20
	18-26	S502UC-K26		18-26	S504UC-K26
	23-32	S502UC-K32		23-32	S504UC-K32
29-37	S502UC-K37	29-37	S504UC-K37		
34-41	S502UC-K41	34-41	S504UC-K41		
38-45	S502UC-K45	38-45	S504UC-K45		

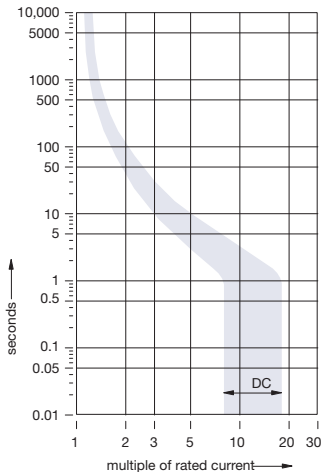

# Accessories

## S500 UL 1077

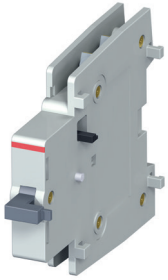

S500-H

### Auxiliary contacts

The auxiliary contacts will signal whether the breaker is in the ON or OFF position.

Description	Catalog number
For field mounting: left side	
1 N.O./1 N.C.	S500-H11
2 N.O.	S500-H20

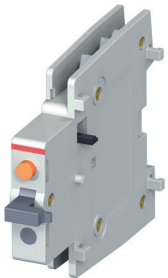

S500-S

### Bell alarm—signal contact

The bell alarm includes a set of contacts that will only signal when the breaker has tripped. Typically, the contacts would be connected to an alarm or bell to signal the operator that an overcurrent trip has occurred. The bell alarm also includes a test button for testing the alarm contacts without opening the breaker.

Description	Catalog number
For field mounting: left side	
1 N.O./1 N.C.	S500-S11
2 N.O.	S500-S20

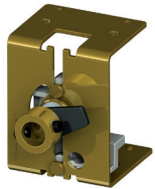

S500-RD3

### Handle mechanism

Description	Catalog number
Handle mechanism	S500-RD3

### Power feed terminal—Accepts into 2/0 AWG

Description	Catalog number
Rear mount terminal	S500-K2

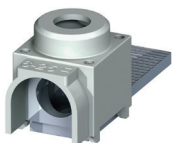

S500-K1

### Rear mount terminal—Accepts into 2/0AWG

Description	Catalog number
Accepts 4 AWG/25 mm	S500-K1

# Technical specifications S500-K and S500UC-B, K

## Auxiliary contact S800-AUX

	S500-K	S500UC-B, K
<b>Approvals</b>		
UL	1077	1077
CSA	C22.2-No. 235	C22.2-No. 235
<b>Number of poles</b>	1, 2, 3	1, 2, 3, 4
<b>Tripping characteristic</b>	K	B, K
<b>Rated current</b>	0.1 to 45 A	B: 6-63 A; K: 0.15-45 A
<b>Rated voltage</b>	600Y/347 VAC	1 pole 250 VDC 2 pole 500 VDC 3 pole 600 VDC 4 pole 600 VDC
<b>Frequency</b>	50/60 Hz	50/60 Hz
<b>Mounting position</b>	vertical, horizontal	vertical, horizontal
<b>Standard mounting</b>	35 mm DIN rail	35 mm DIN rail
<b>Clamps only for CU</b>	16-4 AWG	16-4 AWG
<b>Service life, mechanical at rated load</b>	20,000	20,000
<b>Ambient temperature</b>	40 °C...104 °F	40 °C...104 °F

Trip curve K

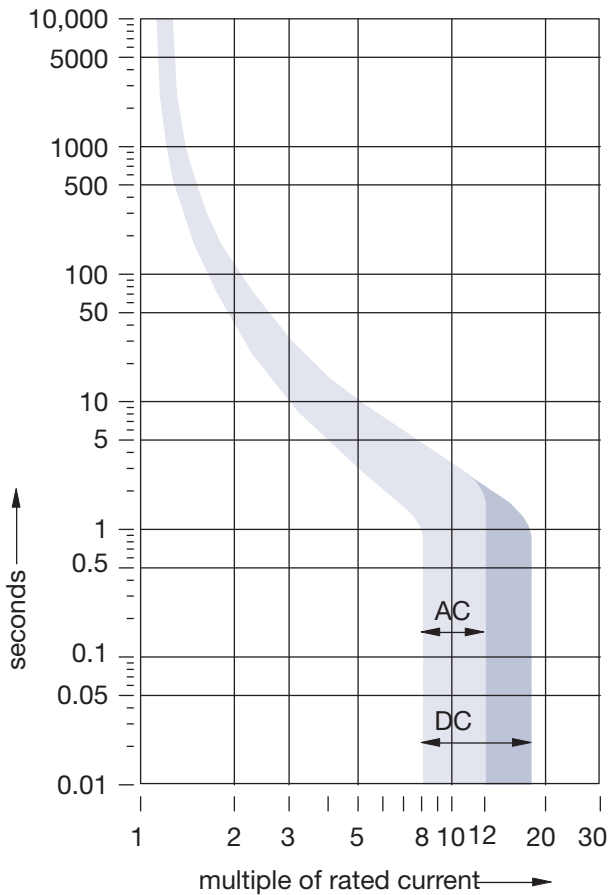

Trip curve B

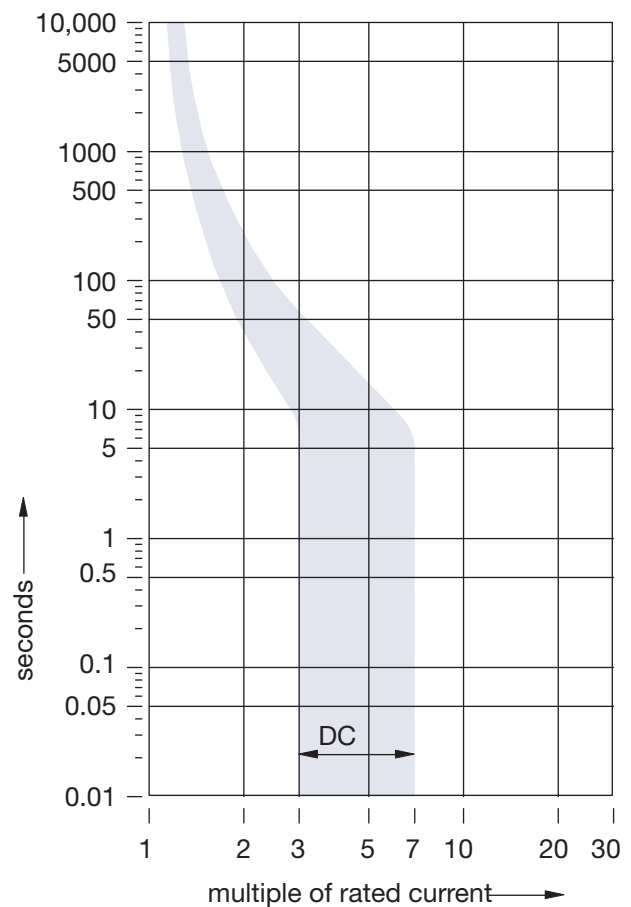

# Approximate dimensions S500 and accessories

## S500

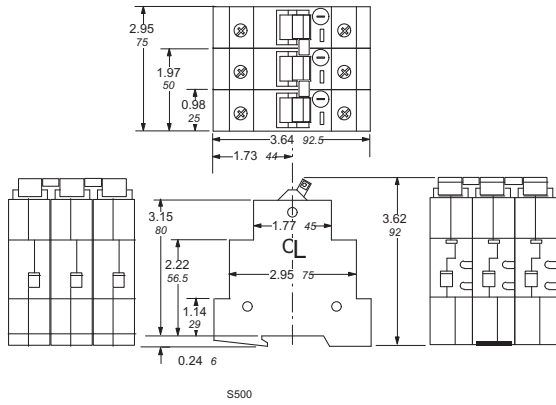

## S500-H11, S500-H20, S500-S11, and S500-S20

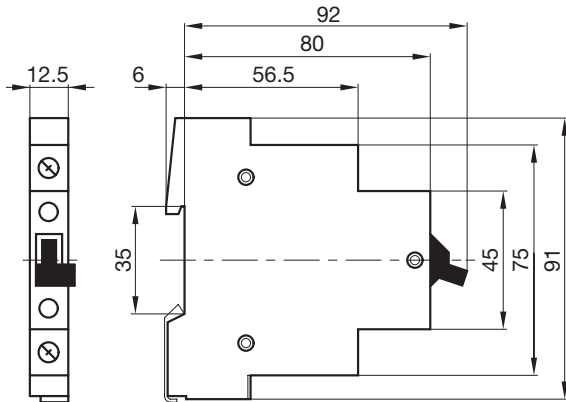

## S500-RD3 Handle mechanism

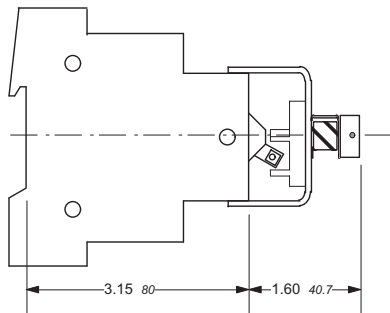

## S500 Front mounting kit

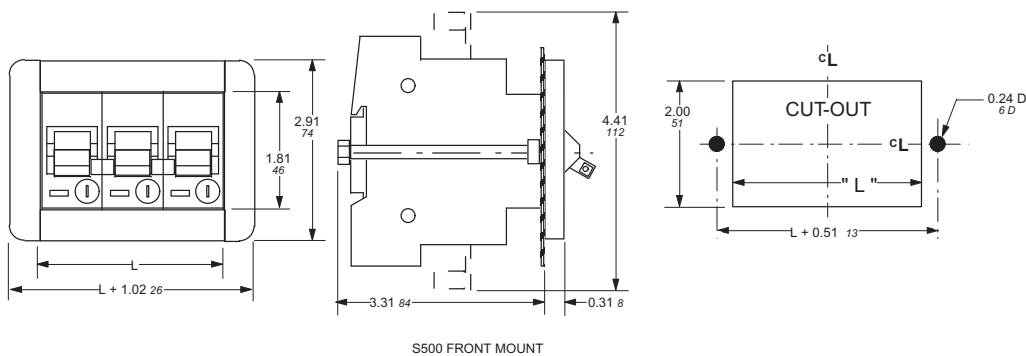

# Electronic Protection Device EPD24-TB-101

For use on the load side of 24 V DC switch mode power supplies

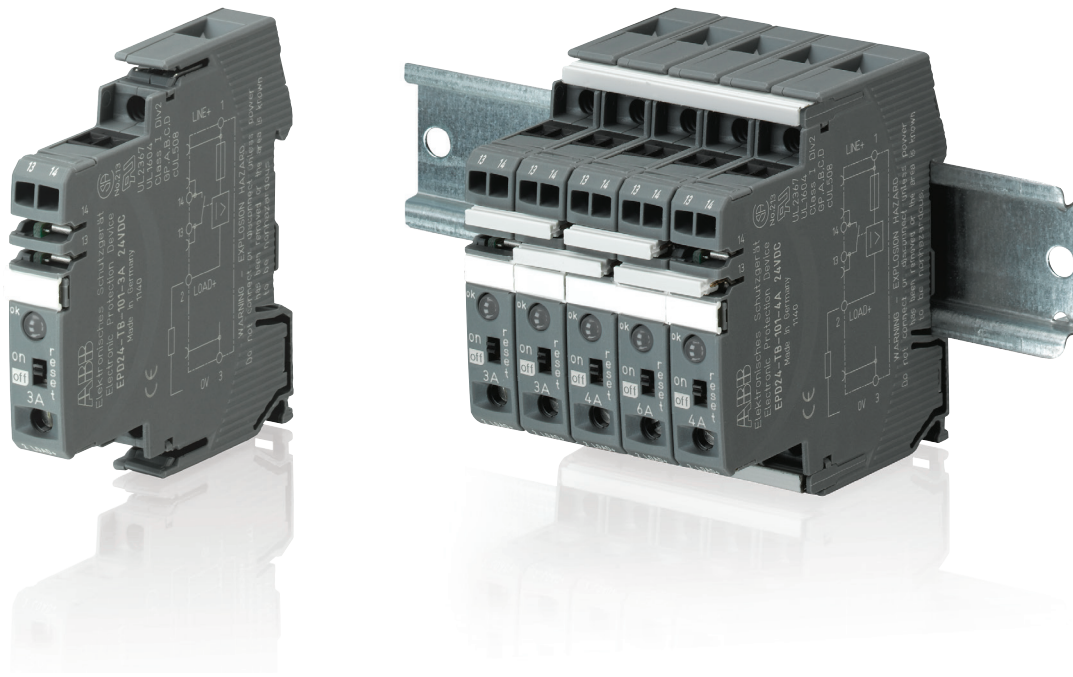

## Description

The protection devices EPD24 extend the ABB product range of Modular DIN Rail Components by electronic overcurrent protection modules for selective protection of 24 V DC load circuits. This protection is achieved by a combination of active electronic current limitation in the case of a short circuit and an overload deactivation from 1.1 x IN upwards.

If a fault occurs in a load circuit, the protection device EPD24 will detect this rapidly and reliably, disable the power output transistor and hence interrupt the current flow in the defective circuit. The maximum possible overcurrent is always limited to 1.3...1.8 times the selected rated current. An activation of capacitive loads up to 20,000 µF is possible, deactivation only occurring in the case of overloads or short circuits. Selective deactivation of the defective current circuit means undefined error states and a complete system stop are prevented.

## Features

- Selective load protection, one electronic tripping characteristic
- Active current limitation for safe connection of capacitive loads up to 20,000 µF and on overload/short circuit
- Current ratings 0.5 A...12 A
- Reliable overload disconnection with 1.1 x IN plus
- Manual ON/OFF button
- Clear status and failure indication through LED and integrated auxiliary contact
- Integral fail-safe element adjusted to current rating
- Width per unit only 12.5 mm
- Rail mounting
- Easy wiring through busbar LINE+ and 0 V as well as signal bars
- UL- and CSA-approvals allow international use of the devices

## Approvals

Authority	Voltage rating	Current ratings
UL 2367	24 V DC	0.5...12 A
UL 1604 (class I, div. 2, groups A, B, C, D)	24 V DC	0.5...12 A
UL 508	24 V DC	0.5...12 A
CSA C22.2 No. 213 (class I, division 2)	24 V DC	0.5...12 A
CSA C22.2 No. 142	24 V DC	0.5...12 A
CSA C22.2 No. 14	24 V DC	0.5...12 A

# EPD24

## Ordering information

### Electronic protection devices

Rated current $I_N$ A	Weight 1 piece in kg	Packing unit	Catalog number
0.5	0.065	4	EPD24-TB-101-0.5A
1	0.065	4	EPD24-TB-101-1A
2	0.065	4	EPD24-TB-101-2A
3	0.065	4	EPD24-TB-101-3A
4	0.065	4	EPD24-TB-101-4A
6	0.065	4	EPD24-TB-101-6A
8	0.065	4	EPD24-TB-101-8A
10	0.065	4	EPD24-TB-101-10A
12	0.065	4	EPD24-TB-101-12A

### Accessories

	Catalog number	Weight 1 piece in kg	Packing unit
Busbars for LINE+ and 0 V, grey insulation, length 500 mm <sup>1)</sup>	EPD-BB500	0.20	10
Signal bars for auxiliary contacts, grey insulation, length 21 mm	EPD-SB21	0.04	10

<sup>1)</sup> Ampacity at one line entry  $I_{max} = 50$  A (Recommendation: mid line entry)  
Ampacity at two line entries  $I_{max} = 63$  A

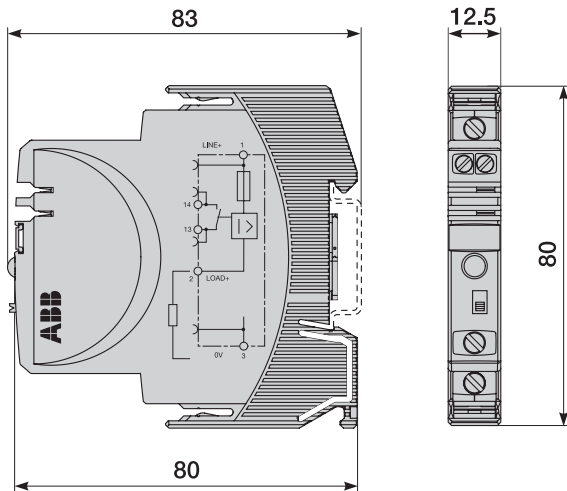





# Notes

A series of 30 horizontal dotted lines for writing notes.

# Contact us

## **ABB**

Electrification Products  
8155 T&B Boulevard  
Memphis, TN 38125  
[www.abb.us/lowvoltage](http://www.abb.us/lowvoltage)

Customer Service: 800-816-7809  
7:00 a.m. - 5:30 p.m., CST, Monday-Friday  
[elec\\_custserv@tnb.com](mailto:elec_custserv@tnb.com)  
Technical Support: 888-385-1221, Option 1  
7:00 a.m. - 5:00 p.m., CST, Monday-Friday  
[lvps.support@us.abb.com](mailto:lvps.support@us.abb.com)

We reserve the right to make technical changes or modify the contents of this document without prior notice. With regard to purchase orders and/or contracts, the agreed particulars shall prevail. ABB does not accept any responsibility whatsoever for potential errors or possible lack of information in this document. We reserve all rights in this document and in the subject matter and illustrations contained therein. Any reproduction, disclosure to third parties or utilization of its contents – in whole or in parts – is forbidden without prior written consent of ABB.

© Copyright 2016 ABB. All Rights Reserved.

1SXU40208C0201, December 2016

