

250 x 110 x 30 cm

98.4" x 43.3" x 11.8"

SIMONCLICK SUPERPLUS 6/300

5 Años Garantía
Years Guarantee
Jahre Garantie
Ans Garantie
Anos de Garantía

SIMONRACK

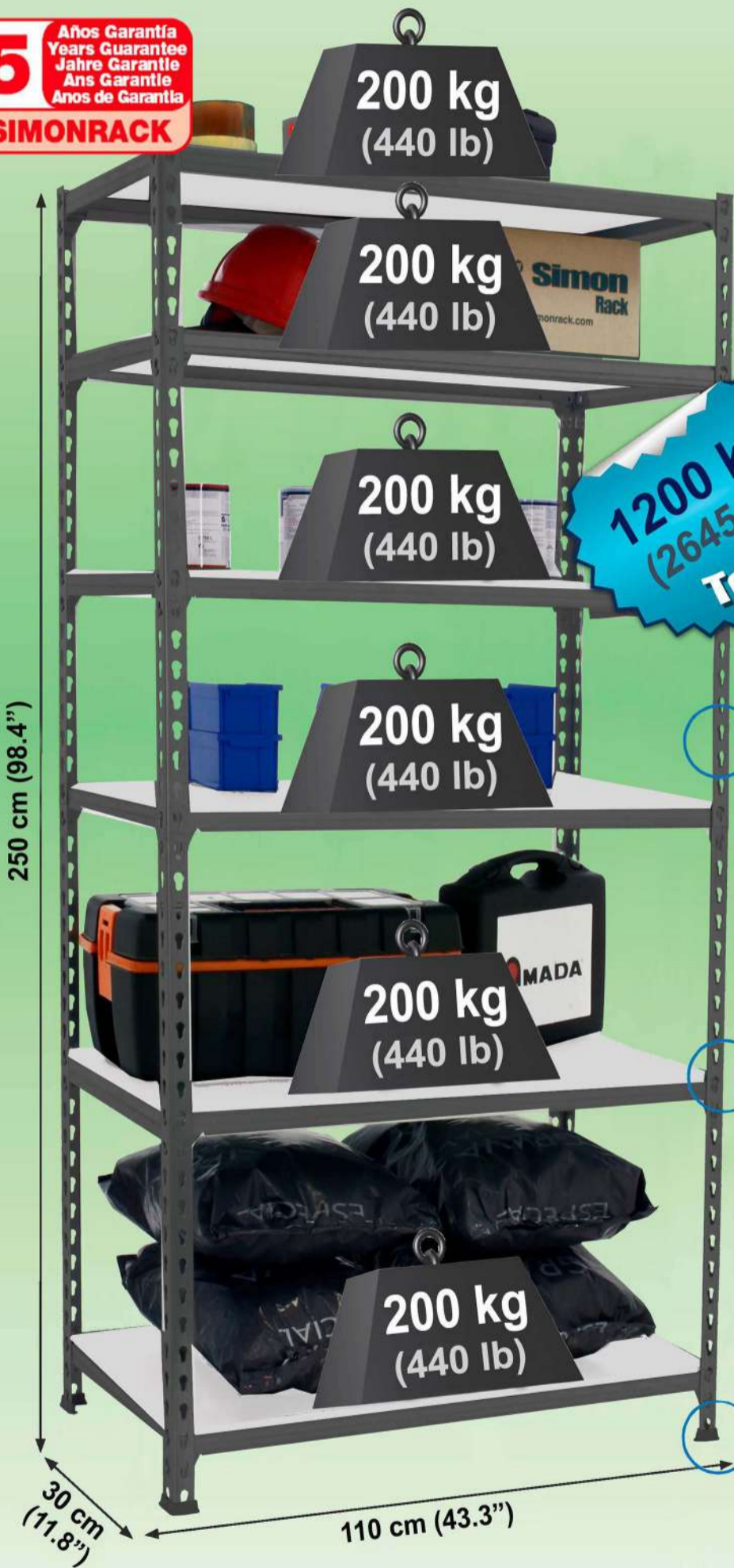

1200 kg
(2645 lb)
Total

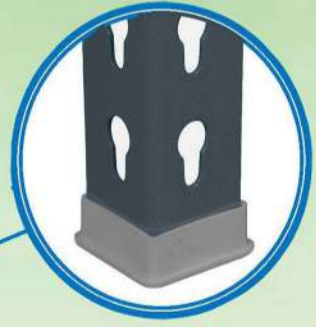

*MEDIDAS EN USO / USED MEASUREMENTS
MASSAHEIMEN IM EINSATZ / MEASURES IN EMPLOY / MEDIDAS EN USO:
2510 x 1110 x 310 mm (98.8" x 43.7" x 12.2")



ESTANTERIAS SIMON S.L. B.50.556.463
PG. ALFAMEN C/ POLIGONO C, Nº3
ALFAMEN (ZARAGOZA)



Simon
Rack
SINCE 1964 - MANUFACTURER



www.simonrack.com



INSTRUCTIONS

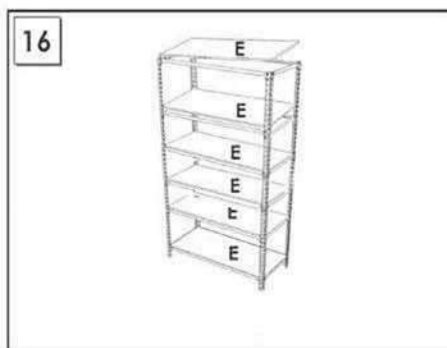
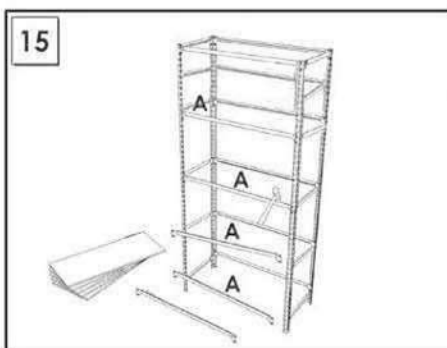
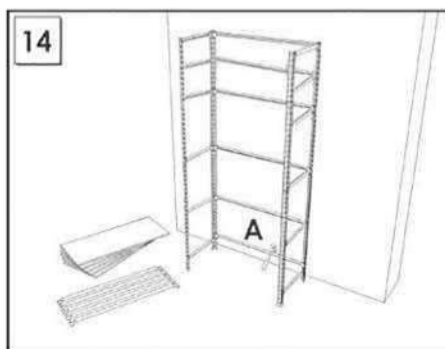
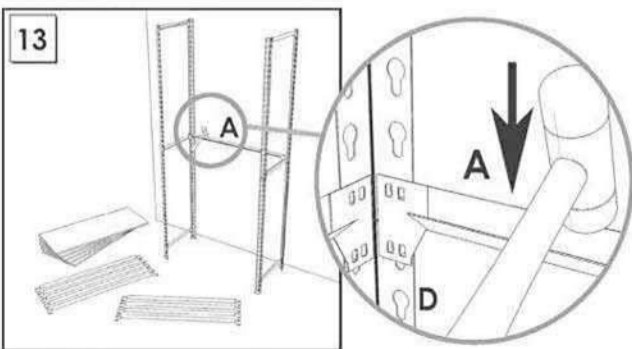
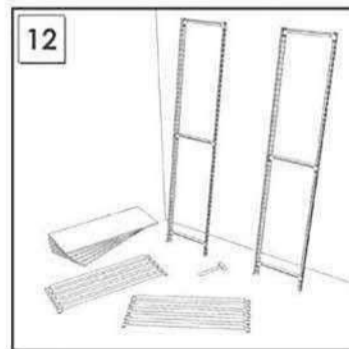
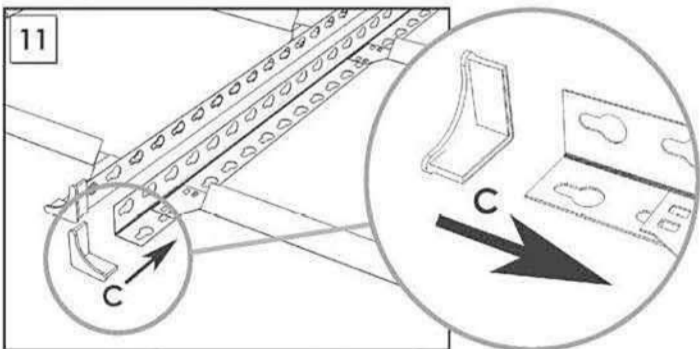
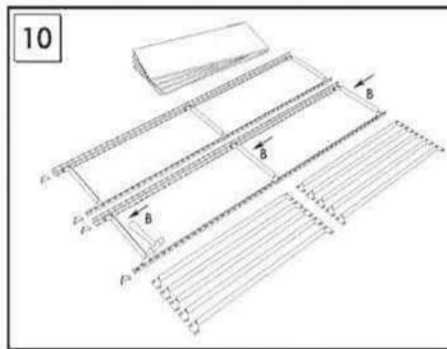
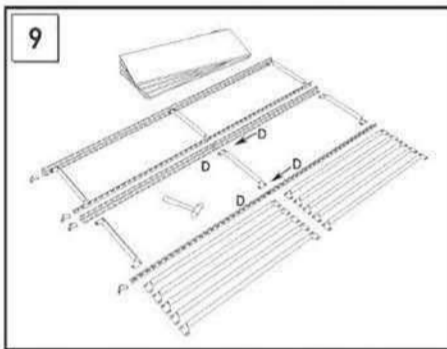
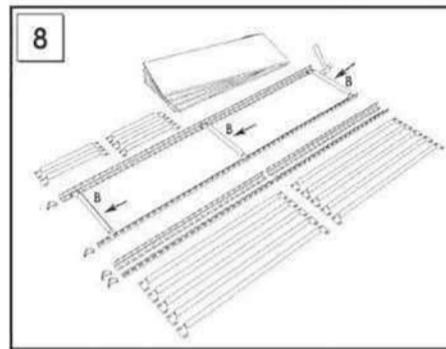
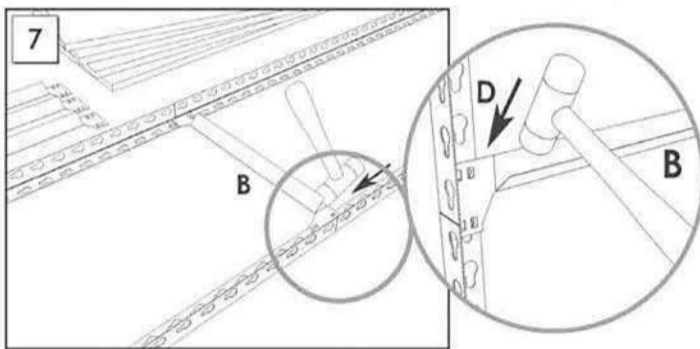
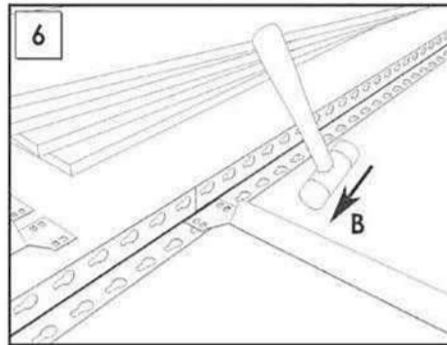
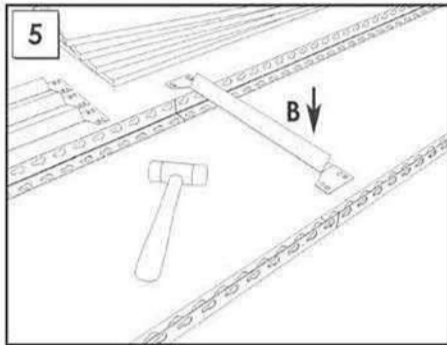
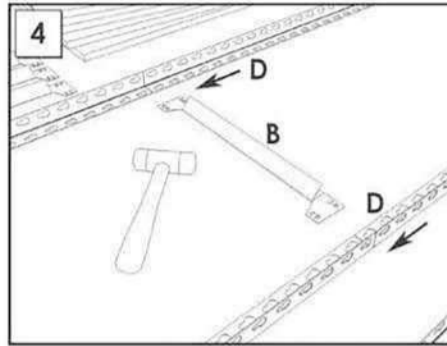
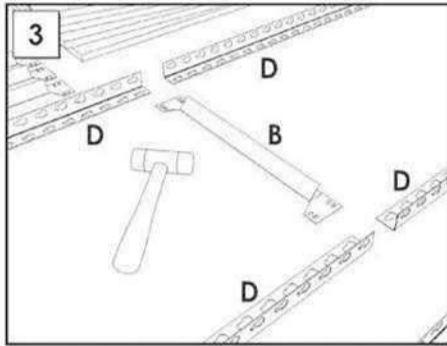
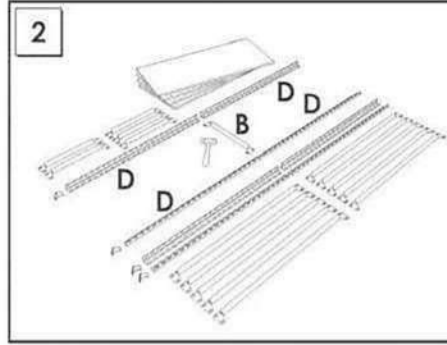
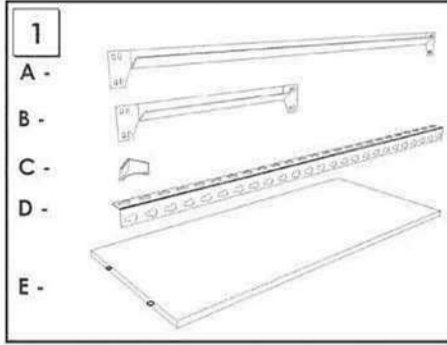

SIMONCLASSIC



SIMONCLICK



SIMONTALLER



SIMONAUTO



SIMONWORK



SIMONLOCKER



SIMONOFFICE



SIMONHOME



SIMONGARDEN



SIMONTITÁN



SIMONINOX



SIMONINDUSTRIAL

SIMONPALET



SIMONLEVER



AL TILLOS Y PASILLOS ELEVADOS
PLATFORMS AND MEZZANINES
LAGERBÜHNEN • PLATES-FORMES ET MEZZANINES



* Kg / lb por bandeja con carga uniformemente repartida
Kg / lb per shelf uniformly distributed load
Kg / lb pro fach bei gleichmäßig verteilter last
Kg / lb par plateau avec charge uniformément répartie

