

## angular milling cutter 90° VSM490™-15 with thread

for indexable milling inserts XN.U 15T6..

**WIDIA** 

### Application:

the WIDIA™ Victory™ angular milling cutter range VSM490™-10 or 15 has been specifically developed for higher cutting volumes and excellent surface qualities of plane surfaces and shoulders. the 90° angular milling cutters are suitable for a wide range of material applications – steel, cast iron, stainless steel and titanium – for machining ranging from roughing to finishing.

### Execution:

- double-sided, robust indexable insert with four cutting edges
- highly positive geometry for lower cutting forces
- excellent surface quality on shoulder and front surface
- with internal cooling

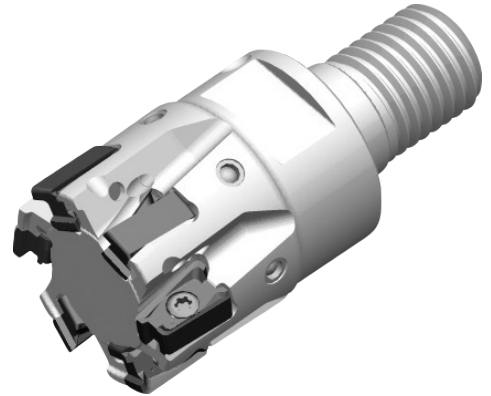

<b>Art. no.</b>	<b>16043 602</b>
<b>Brand</b>	WIDIA
<b>Manufacturer Part Number</b>	5873212
<b>Cutting edge diameter</b>	32 mm
<b>Clearance length</b>	40 mm
<b>Thread dimension</b>	M16
<b>max. ap</b>	15 mm
<b>Number of cutting edges</b>	3 PCS
<b>Gross Weight</b>	0.231 kg
<b>Product Group</b>	1XJ

### EAN

4050841730327