

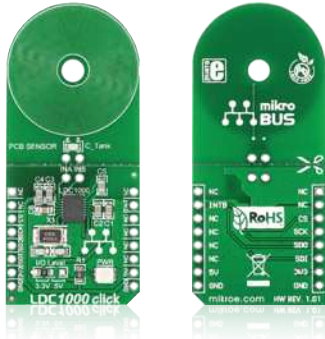

LDC1000 click™

1. Introduction



LDC1000 click™ carries the world's first **inductance-to-digital** converter IC, along with a detachable sensor (an LC tank comprising a 36-turn PCB coil and a 100pF 1% NPO capacitor). The board can be used for short range measurements of the position, motion or composition of conductive targets. LDC1000 click™ communicates with the target board through mikroBUS™ SPI (CS, SCK, MISO, MOSI) and INT lines. The board is designed to use either a 3.3V or a 5V power supply.

2. Soldering the headers

Before using your click™ board, make sure to solder 1x8 male headers to both left and right side of the board. Two 1x8 male headers are included with the board in the package.

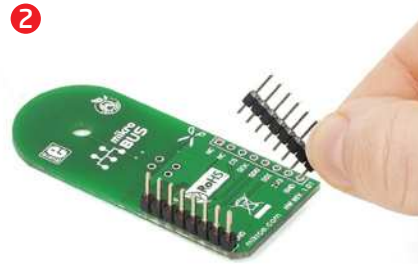
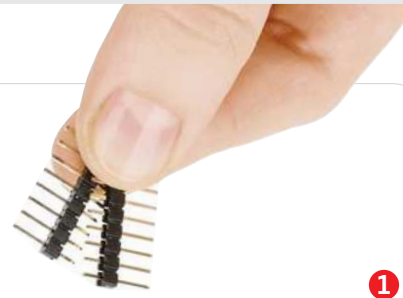

Turn the board upside down so that the bottom side is facing you upwards. Place shorter pins of the header into the appropriate soldering pads.

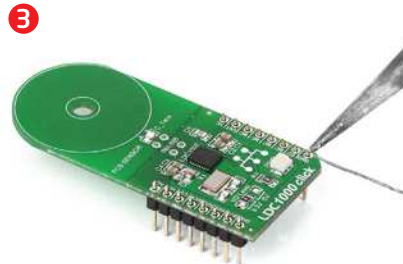

Turn the board upward again. Make sure to align the headers so that they are perpendicular to the board, then solder the pins carefully.



3. Plugging the board in

Once you have soldered the headers your board is ready to be placed into the desired mikroBUS™ socket. Make sure to align the cut in the lower-right part of the board with the markings on the silkscreen at the mikroBUS™ socket. If all the pins are aligned correctly, push the board all the way into the socket.

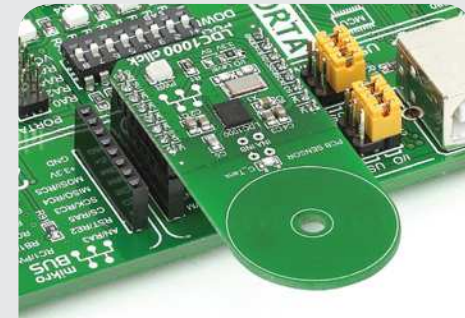

4. Essential features

Inductive sensing is a contactless, magnet-free technology. It's highly reliable making it suitable for use in harsh environments - dust, dirt, oil or moisture don't hinder its performance. LDC1000 click™ allows you to achieve a high level of sensing precision with a sub-micron resolution in short range applications. You can use it to infer attributes such as position, rotation, motion, twist and torque, shape and even defects in the material composition from any conductive target. Onboard INA and INB pins allow you to replace the provided detachable sensor and solder your own.

click™
BOARD
www.mikroe.com

LDC1000 click™ manual
ver. 1.01
0 100000 026854

5. LDC1000 click™ board schematic

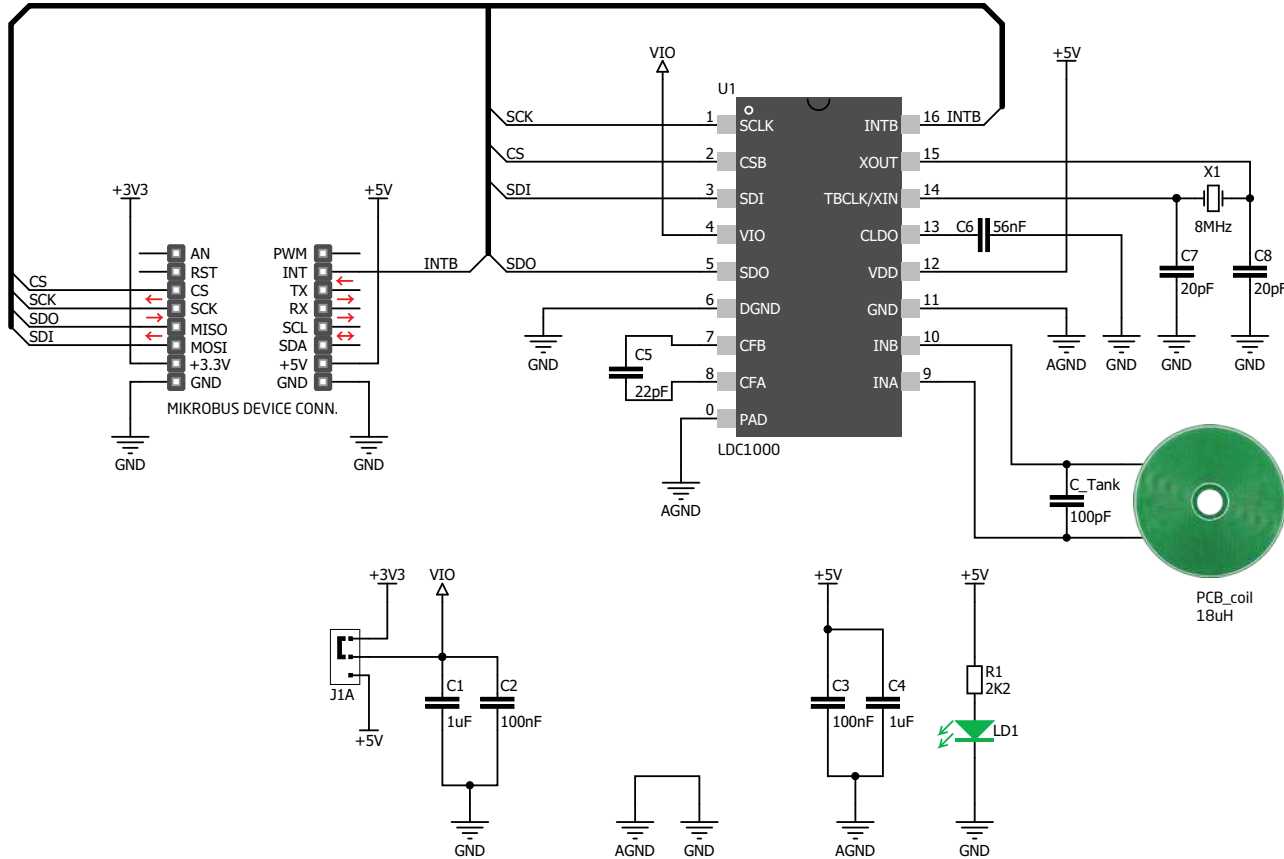

6. SMD jumper

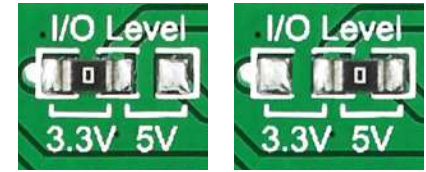

To switch between 3.3V and 5V power supplies use the on-board zero-ohm SMD jumper. By default it's soldered in the 3.3V position.

7. Code examples

Once you have done all the necessary preparations, it's time to get your click™ board up and running. We have provided examples for mikroC™, mikroBasic™ and mikroPascal™ compilers on our **Libstock** website. Just download them and you are ready to start.



8. Support

MikroElektronika offers **free tech support** (www.mikroe.com/support) until the end of the product's lifetime, so if something goes wrong, we're ready and willing to help!