

# KLKD SERIES 10x38 FUSES

600 Vac/dc • 1/10-30 A • Fast Acting



## Description

The KLKD fuse series is fast-acting with a high DC voltage rating. This family of Midget style fuses (10 x 38 mm) is used in solar combiner boxes and in circuits with DC fault currents up to 50,000 amperes. KLKD fuses are available in standard and board-mount configurations.

In addition, the KLKD series has been designed to meet both the UL and IEC photovoltaic fuse standards.

Littelfuse offers a wide range of ampere ratings to match specific requirements in a variety of applications.

## Features/Benefits

- Designed to UL and IEC photovoltaic specifications
- 1/10 - 30 A ratings available
- 50,000 A Interrupting Rating
- Available in ferrule or PCB mount options
- 1-5 A meets UL1741 GFDI requirements

## Applications

- Combiner boxes and Inverters
- Power supplies
- Desktop meters

## Dimensions Inches (mm)

### Ferrule Version

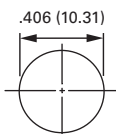
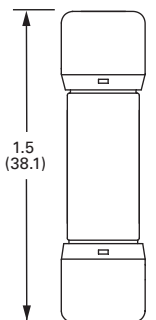

### PCB 1-Tab

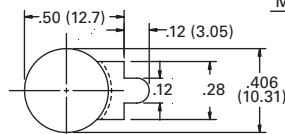
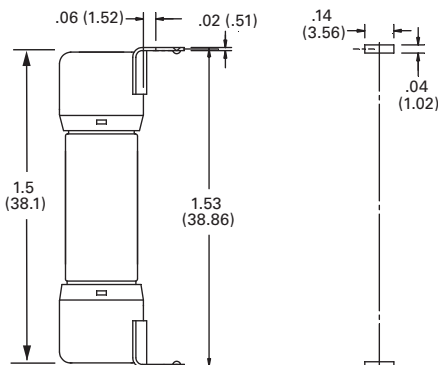

MOUNTING HOLE  
DETAIL

## Specifications

<b>Voltage Rating:</b>	600 Vac/Vdc
<b>Amperage Rating:</b>	1/10, 1/8, 2/10, 1/4, 3/10, 1/2, 3/4, 1, 1 1/2, 2, 2 1/2, 3, 3 1/2, 4, 5, 6, 7, 8, 9, 10, 12, 15, 20, 25, 30
<b>Interrupting Ratings:</b>	AC: 100 kA 200 kA Littelfuse self-certified
<b>Material:</b>	Body: Melamine / Caps: Copper Alloy
<b>Operating Temperature:</b>	See Rating Curve
<b>Approvals:</b>	UL 248-19 Listed (File: E339112) IEC 60269-6 (2-25 A) VDE Certified (No. 40033094) UL 248-14 Listed (File: E10480) CSA Certified Ferrule only (File: LR29862)
<b>Environmental:</b>	RoHS Compliant
<b>Country of Origin:</b>	Mexico

## Part Numbering System

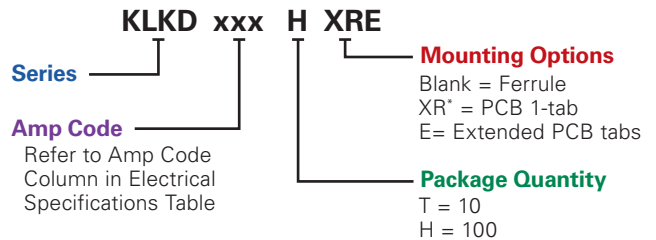

SERIES	AMP	PACKAGE QUANTITY	MOUNTING METHOD	CATALOG NUMBER	ORDERING NUMBER
KLKD	1/8	10	FERRULE	KLKD 1/8	KLKD.125T
KLKD	5	100	FERRULE	KLKD 5	KLKD005.H
KLKD	15	100	PCB 1-TAB	KLKD 15-R	KLKD015.HXR

\*Only available in 100 packs (H) and select ratings.

## Recommended Fuse Holders

Littelfuse LFPSM and LPSM Dead-Front Series  
Littelfuse L60030M Open-Face Series

## Web Resources

Download CAD drawings and other technical information:  
[littelfuse.com/klkd](http://littelfuse.com/klkd)

# KLKD SERIES 10x38 FUSES

## Ordering Information

### Ferrule Version

AMP RATING	AMP CODE	CATALOG NUMBER	ORDERING NUMBER	VOLTAGE		INTERRUPTING RATING (kA)		UPC	WEIGHT LB (G)	AGENCY APPROVALS		
				DC & AC	AC	DC	UL			VDE	CSA	
1/10	.100	KLKD 1/10	KLKD.100T	600	100	50	07945810189	.013 (5.90)	•		•	
1/8	.125	KLKD 1/8	KLKD.125T	600	100	50	07945810190	.013 (5.90)	•		•	
2/10	.20	KLKD 2/10	KLKD.200T	600	100	50	07945810191	.013 (5.90)	•		•	
1/4	.250	KLKD 1/4	KLKD.250T	600	100	50	07945810192	.013 (5.90)	•		•	
3/10	.300	KLKD 3/10	KLKD.300T	600	100	50	07945810193	.013 (5.90)	•		•	
1/2	.500	KLKD 1/2	KLKD.500T	600	100	50	07945810194	.013 (5.90)	•		•	
3/4	.750	KLKD 3/4	KLKD.750T	600	100	50	07945810195	.013 (5.90)	•		•	
1	001	KLKD 1	KLKD001.T	600	100	50	07945810196	.013 (5.90)	•		•	
1 1/2	01.5	KLKD 1 1/2	KLKD01.5T	600	100	50	07945810197	.013 (5.90)	•		•	
2	002	KLKD 2	KLKD002.T	600	100	50	07945810198	.017 (7.71)	•	•	•	
2 1/2	02.5	KLKD 2 1/2	KLKD02.5T	600	100	50	07945810199	.017 (7.71)	•	•	•	
3	003	KLKD 3	KLKD003.T	600	100	50	07945810200	.017 (7.71)	•	•	•	
3 1/2	03.5	KLKD 3 1/2	KLKD03.5T	600	100	50	07945810214	.017 (7.71)	•	•	•	
4	004	KLKD 4	KLKD004.T	600	100	50	07945810201	.017 (7.71)	•	•	•	
5	005	KLKD 5	KLKD005.T	600	100	50	07945810202	.017 (7.71)	•	•	•	
6	006	KLKD 6	KLKD006.T	600	100	50	07945810203	.017 (7.71)	•	•	•	
7	007	KLKD 7	KLKD007.T	600	100	50	07945810204	.017 (7.71)	•	•	•	
8	008	KLKD 8	KLKD008.T	600	100	50	07945810205	.017 (7.71)	•	•	•	
9	009	KLKD 9	KLKD009.T	600	100	50	07945810215	.017 (7.71)	•	•	•	
10	010	KLKD 10	KLKD010.T	600	100	50	07945810206	.017 (7.71)	•	•	•	
12	012	KLKD 12	KLKD012.T	600	100	50	07945810207	.017 (7.71)	•	•	•	
15	015	KLKD 15	KLKD015.T	600	100	50	07945810208	.017 (7.71)	•	•	•	
20	020	KLKD 20	KLKD020.T	600	100	50	07945810209	.017 (7.71)	•	•	•	
25	025	KLKD 25	KLKD025.T	600	100	50	07945810210	.017 (7.71)	•	•	•	
30	030	KLKD 30	KLKD030.T	600	100	50	07945810211	.017 (7.71)	•		•	

### PCB 1-Tab Version

AMP RATING	AMP CODE	CATALOG NUMBER	ORDERING NUMBER	VOLTAGE RATING		INTERRUPTING RATING (kA)		UPC	APPROVALS	
				DC & AC	AC	DC	UL		CE	
1/10	.100	KLKD 1/10-R	KLKD.100HXR	600	100	50	07945814857	•	•	
1/2	.500	KLKD 1/2-R	KLKD.500HXR	600	100	50	07945814858	•	•	
1	001	KLKD 1-R	KLKD001.HXR	600	100	50	07945812133	•	•	
2	002	KLKD 2-R	KLKD002.HXR	600	100	50	07945894349	•	•	
3	003	KLKD 3-R	KLKD003.HXR	600	100	50	07945818991	•	•	
4	004	KLKD 4-R	KLKD004.HXR	600	100	50	07945811495	•	•	
5	005	KLKD 5-R	KLKD005.HXR	600	100	50	07945814859	•	•	
6	006	KLKD 6-R	KLKD006.HXR	600	100	50	07945894350	•	•	
8	008	KLKD 8-R	KLKD008.HXR	600	100	50	07945894351	•	•	
10	010	KLKD 10-R	KLKD010.HXR	600	100	50	07945814860	•	•	
12	012	KLKD 12-R	KLKD012.HXR	600	100	50	07945894352	•	•	
15	015	KLKD 15-R	KLKD015.HXR	600	100	50	07945894353	•	•	
20	020	KLKD 20-R	KLKD020.HXR	600	100	50	07945894354	•	•	
25	025	KLKD 25-R	KLKD025.HXR	600	100	50	07945894355	•	•	
30	030	KLKD 30-R	KLKD030.HXR	600	100	50	07945894356	•	•	

# KLKD SERIES 10x38 FUSES

## Electrical Specifications

AMP RATING	CATALOG NUMBER	NOM COLD RESISTANCE (ohms)	AVERAGE MELT TIME	AVERAGE MELTING I <sup>2</sup> t	WATTS LOSS AT 100% RATED CURRENT (W)	WATTS LOSS AT 80% RATED CURRENT (W)	AVERAGE CLEARING TIME	TOTAL CLEARING I <sup>2</sup> t (A <sup>2</sup> s) 20 kA	TOTAL CLEARING I <sup>2</sup> t (A <sup>2</sup> s) 100 kA
1/10	KLKD 1/10	85.5	–	–	0.780	0.505	0.000047	0.019	–
1/8	KLKD 1/8	65	–	–	0.975	0.659	0.000050	0.010	–
2/10	KLKD 2/10	30.9	–	–	1.213	0.773	0.000073	0.032	–
1/4	KLKD 1/4	22	–	–	1.364	0.870	–	–	–
3/10	KLKD 3/10	16.2	–	–	1.519	0.960	0.000101	0.067	–
1/2	KLKD 1/2	8.16	–	–	1.961	1.237	0.000141	0.197	–
3/4	KLKD 3/4	0.402	0.000063	0.234	0.361	0.199	0.000170	0.753	–
1	KLKD 1	0.252	0.000094	0.678	0.388	0.273	0.000247	1.827	0.008
1 1/2	KLKD 1 1/2	0.134	0.000153	2.890	0.409	0.229	0.000828	13.956	280
2	KLKD 2	0.129	0.000145	2.379	0.823	0.606	0.000291	3.919	0.012
2 1/2	KLKD 2 1/2	0.0989	0.000186	5.142	0.912	0.618	0.000387	8.877	–
3	KLKD 3	0.0773	0.000211	7.821	0.957	0.654	0.000449	14.835	–
3 1/2	KLKD 3 1/2	0.0613	0.000249	12.417	1.12	0.826	0.000471	21.048	–
4	KLKD 4	0.0511	0.000284	18.945	1.367	0.891	0.000507	30.76	0.019
5	KLKD 5	0.0363	0.000347	34.163	1.4	0.938	0.000607	56.514	0.024
6	KLKD 6	0.0261	0.000423	62.951	1.516	0.998	0.000735	96.824	0.035
7	KLKD 7	0.0205	0.000505	105.143	1.577	1.066	0.000898	168.578	0.087
8	KLKD 8	0.0194	0.000541	130.266	1.824	1.205	0.000945	210.595	0.656
9	KLKD 9	0.0166	0.000587	164.221	2.208	1.428	0.000992	266.633	–
10	KLKD 10	0.0128	0.000701	278.390	1.893	1.3	0.001200	454.628	211.667
12	KLKD 12	0.0103	0.000822	445.010	2.296	1.584	0.001455	744.775	440
15	KLKD 15	.007855	0.000544	137.333	2.045	1.57	0.001721	351.24	–
20	KLKD 20	0.0045	0.000826	462.056	2.133	1.593	0.006144	1151.185	2120
25	KLKD 25	0.003532	0.001007	834.529	2.55	1.933	0.002085	1744.033	2085
30	KLKD 30	0.002776	0.001207	1409	3.701	1.983	0.002266	2757	3220

Note: Test Circuit 600 Vac / 20 kA

# KLKD SERIES 10x38 FUSES

## Current-Limiting Effects

SHORT CIRCUIT CURRENT*	APPARENT RMS SYMMETRICAL CURRENT FOR VARIOUS FUSE RATINGS			
	1 ½ A	12 A	25 A	30 A
5,000	240	292	654	722
10,000	303	367	823	910
15,000	347	420	943	1042
20,000	381	463	1037	1147
25,000	411	498	1117	1235
30,000	437	530	1188	1313
35,000	460	558	1250	1382
40,000	481	583	1307	1445
50,000	518	628	1408	1556
60,000	550	667	1496	1654
80,000	605	735	1647	1820
100,000	652	791	1774	1961

\*Prospective RMS Symmetrical Amperes Short-Circuit Current

## Electrical Specification – Agency Requirements

AMPERAGE RATING	OPENING TIME (MINUTES)				
	100% of Amp Rating per UL	113% of Amp Rating per IEC	135% of Amp Rating per UL	145% of Amp Rating per IEC	200% of Amp Rating per UL
1/10-30	Temperature Stabilization	60 Min	60 Max	60 Max	4 Max

## Temperature Derating Curve (Temperature of Air Immediately Surrounding Fuse)

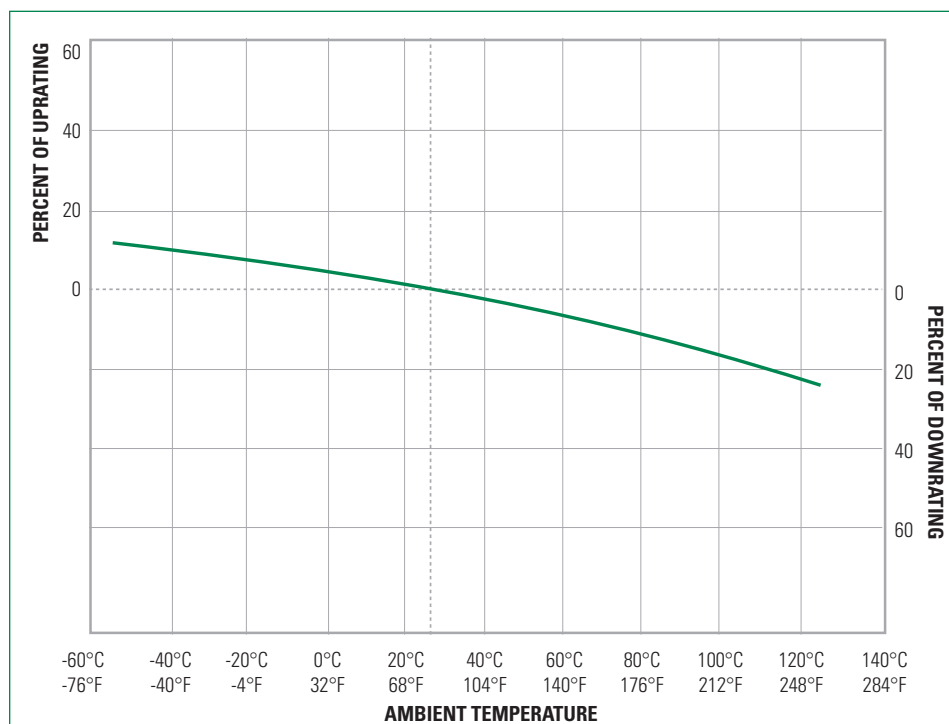

# KLKD SERIES 10x38 FUSES

## Recommended Process and Soldering Parameters

WAVE PARAMETER	LEAD FREE RECOMMENDATION
Preheat:	(Typical Industry Recommendation)
Temperature Minimum:	130° C
Temperature Maximum:	—
Pre-heat time	75 Seconds Maximum
Solder Pot Temperature	280° C Maximum
Solder Dwell Time	270° C for 8 Seconds Maximum
Complete Cycle Time	250 Seconds Maximum

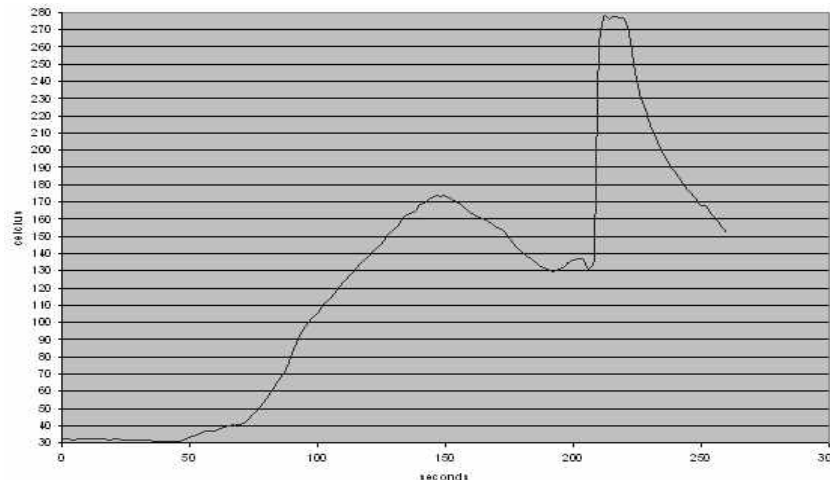

## Peak Let Thru Curve

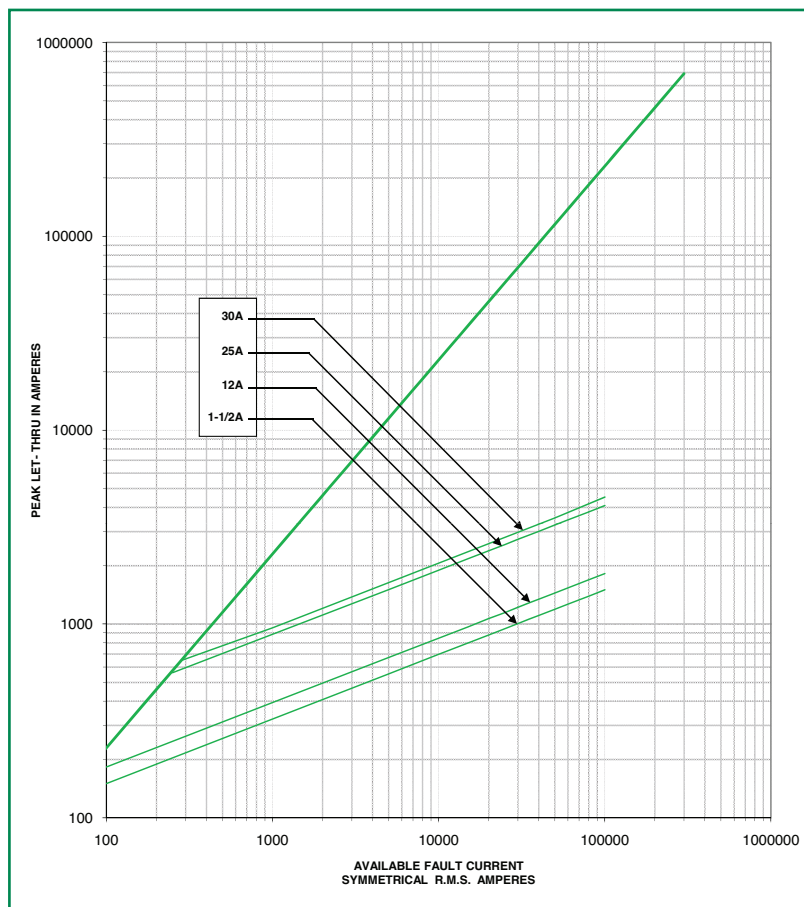

# KLKD SERIES 10x38 FUSES

**Time Current Curve (1/8 - 2 1/2 A)**

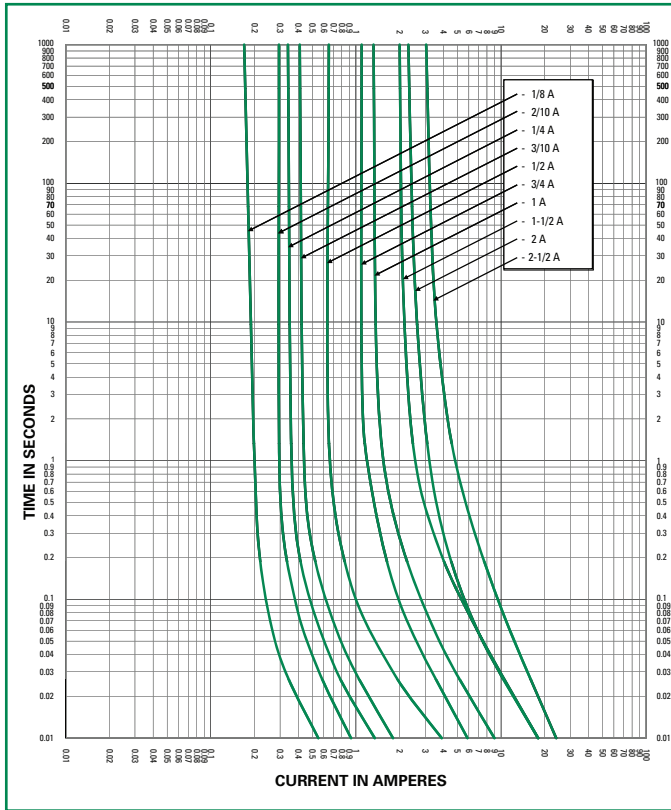

**Time Current Curve (3 - 12 A)**

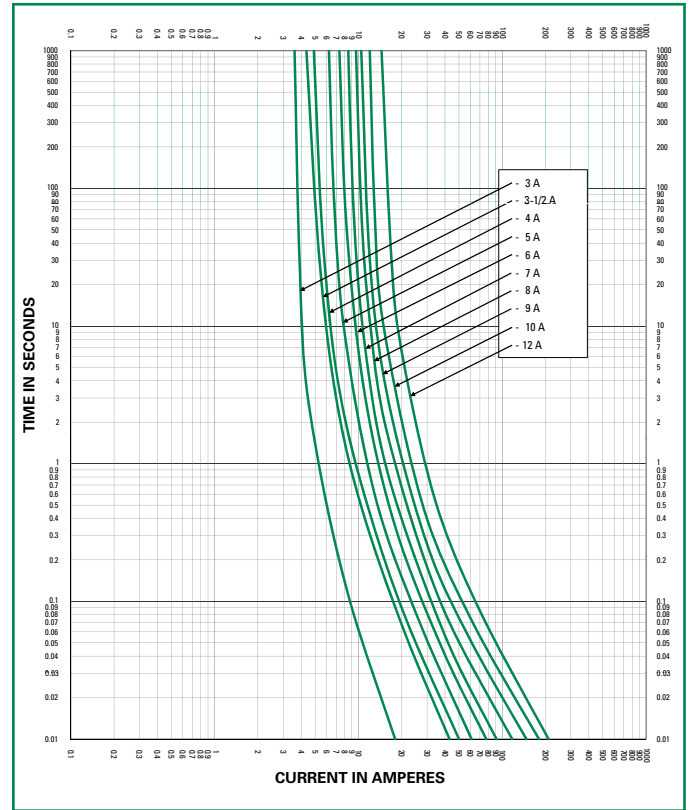

**Time Current Curve (15 - 25 A)**

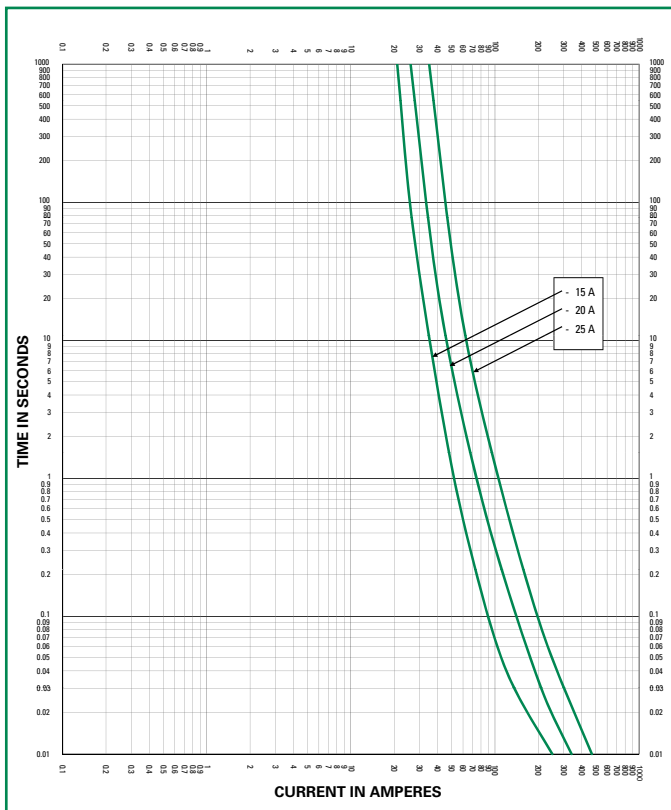

**Time Current Curve (30 A)**

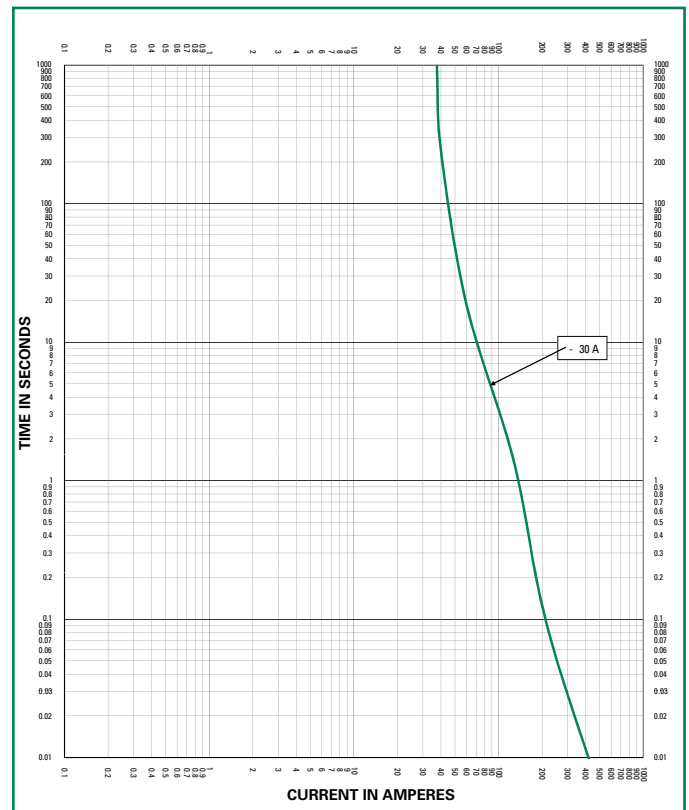

## KLKD SERIES 10x38 FUSES

**Disclaimer Notice** - Littelfuse products are not designed for, and shall not be used for, any purpose (including, without limitation, automotive, military, aerospace, medical, life-saving, life-sustaining or nuclear facility applications, devices intended for surgical implant into the body, or any other application in which the failure or lack of desired operation of the product may result in personal injury, death, or property damage) other than those expressly set forth in applicable Littelfuse product documentation. Warranties granted by Littelfuse shall be deemed void for products used for any purpose not expressly set forth in applicable Littelfuse documentation. Littelfuse shall not be liable for any claims or damages arising out of products used in applications not expressly intended by Littelfuse as set forth in applicable Littelfuse documentation. The sale and use of Littelfuse products is subject to Littelfuse Terms and Conditions of Sale, unless otherwise agreed by Littelfuse.

[Littelfuse.com/Product-Disclaimer](http://Littelfuse.com/Product-Disclaimer)