



Front



Back



■ Features

- Charger for lead-acid batteries (flooded, Gel and AGM) and li-ion batteries (lithium iron and lithium manganese)
- Built-in 3 stage programmable charging curve
- Universal AC input / Full range
- Built-in active PFC function
- Fanless design, cooling by free air convection
- Built-in temperature compensation function
- Protection: Short circuit / Over voltage /Over temperature / Battery under voltage / Battery over voltage / Battery reverse polarity protection
- 3 years warranty

■ Applications

- Radio system backup solution
- Electric scooter charger
- Surveillance system

■ GTIN CODE

MW Search: <https://www.meanwell.com/serviceGTIN.aspx>

■ Description

ENC-120 is a single output 120W AC/DC desktop type charger with 3 stage charging curve. In addition to the embedded pre-defined charging curves, the default curve is programmable and thus able to accommodate different types of batteries, such as lead-acid batteries (gel, flooded and AGM) and li-ion batteries (lithium iron and lithium manganese). With the rugged mechanical design along with the high efficiency circuitry, ENC-120 operates for the ambient temperature range -30~+70°C under free air convection.

■ Model Encoding

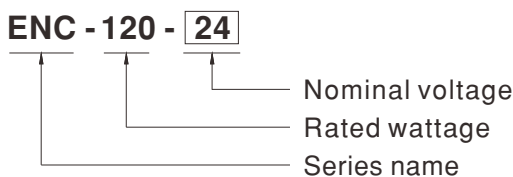



SPECIFICATION

MODEL	ENC-120-12	ENC-120-24	ENC-120-48	
OUTPUT	BOOST CHARGE VOLTAGE(Vboost)(default)	14.4V	28.8V	57.6V
	FLOAT CHARGE VOLTAGE(Vfloat)(default)	13.8V	27.6V	55.2V
	CHARGE VOLTAGE RANGE Note.3	9 ~ 15V	18 ~ 30V	36 ~ 60V
	OUTPUT CURRENT(CC) (default)	8A	4A	2A
	RATED POWER	115.2W	115.2W	115.2W
	RECOMMENDED BATTERY CAPACITY (AMP HOURS) Note.4	30 ~ 80AH	15 ~ 40AH	10 ~ 20AH
	LEAKAGE CURRENT FROM BATTERY (Typ.)	<1mA		
INPUT	VOLTAGE RANGE Note.5	90 ~ 264VAC 127 ~ 370VDC		
	FREQUENCY RANGE	47 ~ 63Hz		
	POWER FACTOR (Typ.)	PF>0.98/115VAC, PF>0.95/230VAC at full load		
	EFFICIENCY (Typ.)	89%	90%	90.5%
	AC CURRENT (Typ.)	1.25A/115VAC 0.63A/230VAC		
	INRUSH CURRENT (Typ.)	COLD START 65A at 230VAC		
	LEAKAGE CURRENT	<3.5mA / 240VAC		
PROTECTION	SHORT CIRCUIT Note.6	Protection type : Shut down O/P voltage, re-power on to recover		
	OVER VOLTAGE Note.7	15.5 ~ 18.2V	31 ~ 36.5V	62.1 ~ 72.9V
	REVERSE POLARITY	By internal fuse		
	OVER TEMPERATURE	Shut down O/P voltage, recovers automatically after temperature goes down		
FUNCTION	TEMPERATURE COMPENSATION	By NTC		
ENVIRONMENT	WORKING TEMP.	-30 ~ +70°C (Refer to "Derating Curve")		
	WORKING HUMIDITY	20 ~ 95% RH non-condensing		
	STORAGE TEMP., HUMIDITY	-40 ~ +85°C, 10 ~ 95% RH non-condensing		
	TEMP. COEFFICIENT	±0.05%/°C (0 ~ 50°C)		
	VIBRATION	10 ~ 500Hz, 2G 10min./1cycle, 60min. each along X, Y, Z axes		
SAFETY & EMC (Note 8)	SAFETY STANDARDS	IEC62368-1, UL62368-1, EAC TP TC 004, BSMI CNS14336-1 approved; Meet BS EN/EN62368-1		
	WITHSTAND VOLTAGE	I/P-O/P:3KVAC I/P-FG:2KVAC O/P-FG:0.5KVAC		
	ISOLATION RESISTANCE	I/P-O/P, I/P-FG, O/P-FG:100M Ohms / 500VDC / 25°C / 70% RH		
	EMC EMISSION	Parameter	Standard	Test Level / Note
		Conducted	BS EN/EN55032 (CISPR32) / FCC PART15 (CISPR22)	Class B
		Radiated	BS EN/EN55032 (CISPR32) / FCC PART15 (CISPR22)	Class B
		Harmonic Current	BS EN/EN61000-3-2	-----
		Voltage Flicker	BS EN/EN61000-3-3	-----
	EMC IMMUNITY	BS EN/EN55024, BSMI CNS13438		
Parameter		Standard	Test Level / Note	
ESD		BS EN/EN61000-4-2	Level 3, 8KV air ; Level 2, 4KV contact	
Radiated		BS EN/EN61000-4-3	Level 2, 3V/m	
EFT / Burst		BS EN/EN61000-4-4	Level 2, 1KV	
Surge		BS EN/EN61000-4-5	Level 2, 1KV/Line-Line, Level 3, 2KV/Line-Earth	
Conducted		BS EN/EN61000-4-6	Level 2, 3Vrms	
Magnetic Field		BS EN/EN61000-4-8	Level 1, 1A/m	
Voltage Dips and Interruptions	BS EN/EN61000-4-11	>95% dip 0.5 periods, 30% dip 25 periods, >95% interruptions 250 periods		
OTHERS	MTBF	1726.4K hrs min. Telcordia SR-332 (Bellcore) ; 206.1K hrs min. MIL-HDBK-217F (25°C)		
	DIMENSION	192*178*45.5mm (L*W*H)		
	PACKING	0.98Kg; 10pcs/10.8Kg /1.38CUFT		
NOTE	<p>1. Modification for charger specification may be required for different battery specification. Please contact battery vendor and MEAN WELL for details.</p> <p>2. All parameters NOT specially mentioned are measured at 230VAC input, rated load and 25°C of ambient temperature.</p> <p>3. This is the range when programming Vboost or Vfloat by using SBP-001, the smart battery charging programmer.</p> <p>4. This is MEAN WELL's suggested range. Please consult your battery manufacturer for their suggestions about maximum charging current limitation.</p> <p>5. Derating may be needed under low input voltages. Please check the derating curve for more details.</p> <p>6. This protection mechanism is specified for the case the short circuit occurs after the charger is turned on.</p> <p>7. Each model incorporates a MCU-controlled dynamic over voltage protection, which is about 115% of Vboost over Constant Current stage and Constant Voltage stage whereas 115% of Vfloat over Float stage.</p> <p>8. The battery charger is considered as an independent unit, but the final equipment still need to re-confirm that the whole system complies with the EMC directives. For guidance on how to perform these EMC tests, please refer to "EMI testing of component power supplies." (as available on http://www.meanwell.com)</p> <p>9. The ambient temperature derating of 3.5°C/1000m with fanless models and of 5°C/1000m with fan models for operating altitude higher than 2000m(6500ft).</p> <p>※ Product Liability Disclaimer : For detailed information, please refer to https://www.meanwell.com/serviceDisclaimer.aspx</p>			

■ Block Diagram

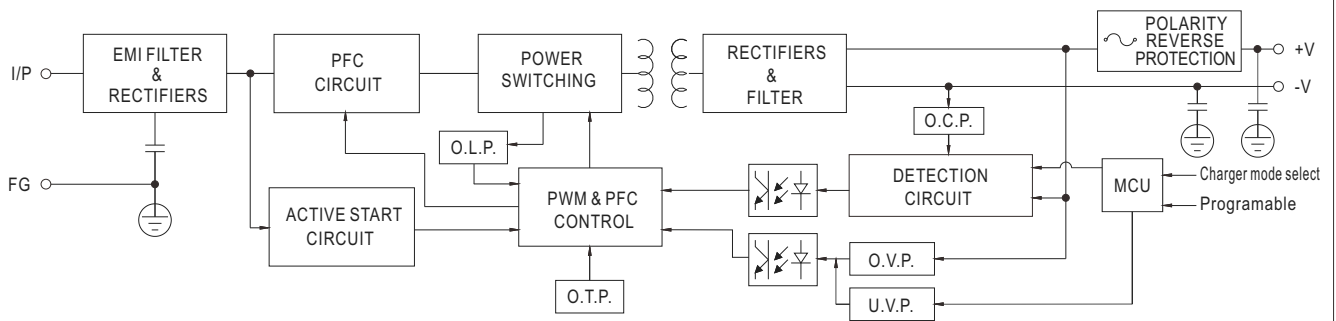

■ Derating Curve

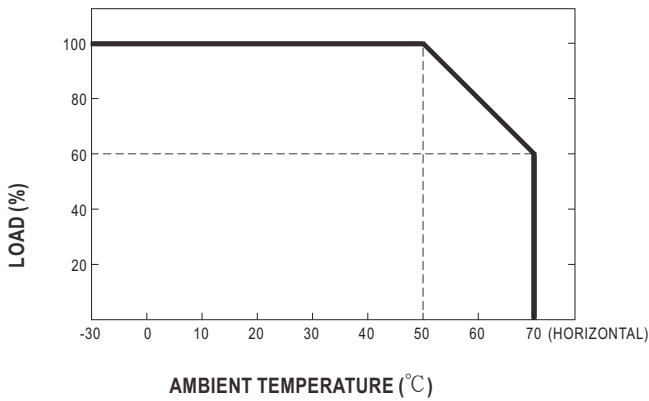

■ Static Characteristics

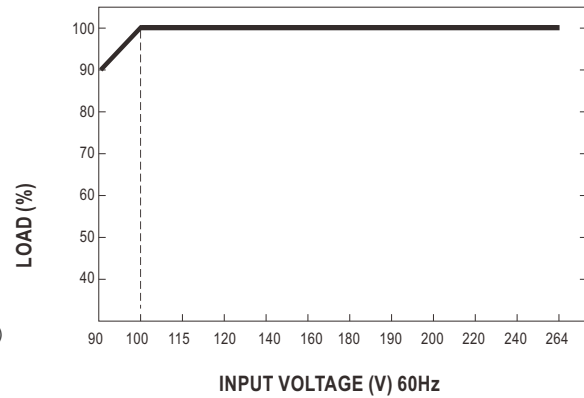

Function Manual

1.Charging Curve

- ※ This series provides a 3 stage charging. The default curve is programmable, whereas other pre-defined curves can be activated by the means of the DIP switch; please refer to the table below and the Mechanical Specification.
- ※ To accommodate the parameters of the charging curve, SBP-001, the smart battery charging programmer designed by MEAN WELL, and a personal computer are needed. Please contact MEAN WELL for details.
- ☉ Default 3 stage charging curve

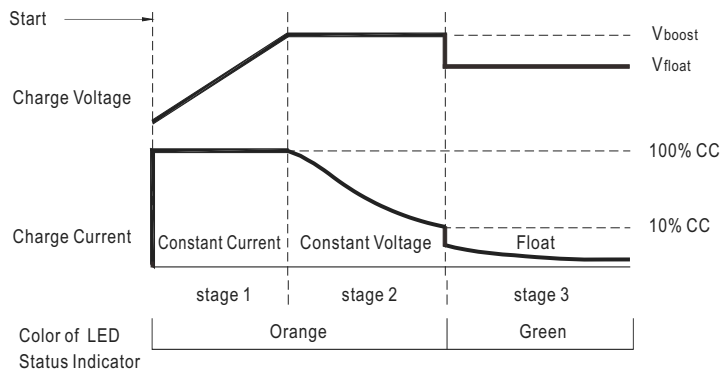

- ☉ Suitable for lead-acid batteries (flooded, Gel and AGM) and Li-ion batteries (lithium iron and lithium manganese).

- ☉ Embedded 3 stage charging curve

MODEL	Description	CC(default)	Vboost	Vfloat
12V	Default, programmable	8A	14.4	13.8
	Pre-defined, gel batter		14	13.6
	Pre-defined, flooded battery		14.2	13.4
	Pre-defined, AGM battery		14.5	13.5
24V	Default, programmable	4A	28.8	27.6
	Pre-defined, gel battery		28	27.2
	Pre-defined, flooded battery		28.4	26.8
	Pre-defined, AGM battery		29	27
48V	Default, programmable	2A	57.6	55.2
	Pre-defined, gel battery		56	54.4
	Pre-defined, flooded battery		56.8	53.6
	Pre-defined, AGM battery		58	54

2. Front Panel LED Indicators & Corresponding Signal at Function Pins

LED	Description
● Green	Float (stage 3)
● Orange	Charging (stage 1 or stage 2)

■ Mechanical Specification

Case No. 252 Unit:mm

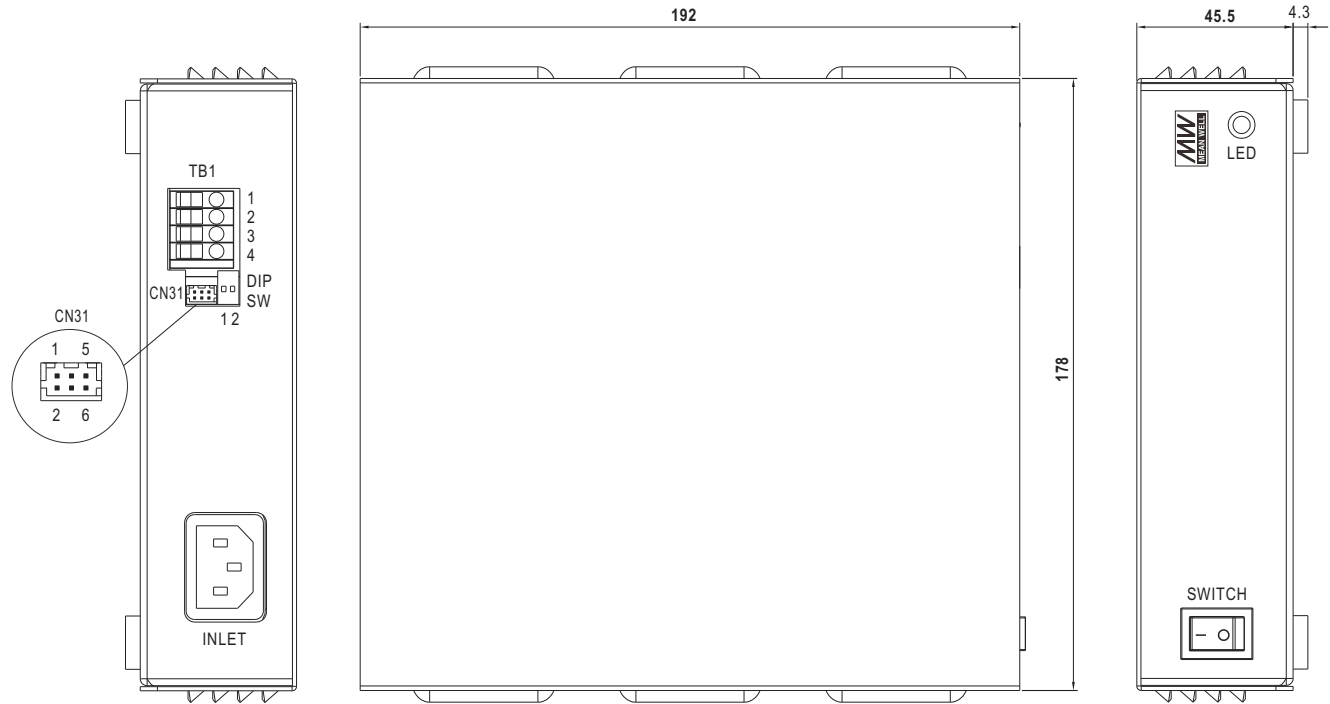

Terminal Pin No. Assignment (TB1):

Pin No.	Assignment
1,2	+V
3,4	-V

Note: Please use wires with a cross section of 0.5 - 4.0 mm² (12~20AWG) for connection.
 Recommended wires strip length is 9 mm and screw torque is 4.0 lb-inch (0.4~0.5Nm).

DIP SW:

1	2	Description
OFF	OFF	Default, programmable
ON	OFF	Pre-defined, Gel battery
OFF	ON	Pre-defined, flooded battery
ON	ON	Pre-defined, AGM battery

Connector Pin No. Assignment (CN31) :
 HRS DF11-6DP-2DS or equivalent

Pin No.	Assignment	Mating Housing	Terminal
1	Prog- +3.3V	HRS DF11-6DS or equivalent	HRS DF11-**SC or equivalent
2	Prog- GND		
3	Prog- RX		
4	Prog- TX		
5	RTH+		
6	RTH-		

■ Accessory List

	Item	Quantity
①	NTC sensor wire	1
②	NTC mating wire	1

NTC sensor wire

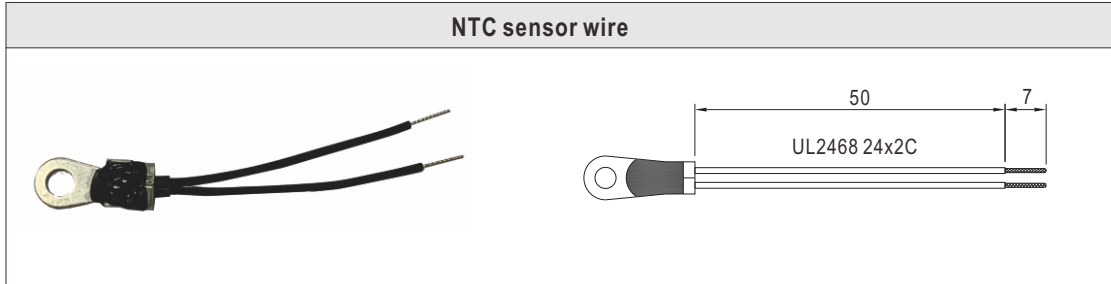

NTC mating wire

