

Sample set - SAMPLE PTSM 0,5/ 3-HHI-2,5-SMD - 1820725

Please be informed that the data shown in this PDF Document is generated from our Online Catalog. Please find the complete data in the user's documentation. Our General Terms of Use for Downloads are valid (<http://phoenixcontact.com/download>)



Header, Nominal current: 6 A, Rated voltage (III/2): 160 V, Number of positions: 3, Pitch: 2.5 mm, Color: black, Contact surface: Tin, Mounting: SMD soldering, Article with anti-rotation pin

The illustration shows a 3-position version

Why buy this product

- Designed for integration into the SMT soldering process
- Supplied in tape-on-reel packing according to IEC 60286-3 for automated mounting
- Inverted header with socket contacts for touch-proof device outputs or PCB/PCB connections
- Additional solder anchors reduce the mechanical strain on the soldering spots



Key Commercial Data

Packing unit	5 STK
Minimum order quantity	5 STK
GTIN	
GTIN	4046356787390
Weight per Piece (excluding packing)	1.620 g
Custom tariff number	85369010
Country of origin	Germany

Technical data

Dimensions

Pitch	2.5 mm
Dimension a	5 mm

General

Range of articles	PTSM 0,5/..-HHI-SMD
Insulating material group	IIIa
Rated surge voltage (III/3)	2.5 kV
Rated surge voltage (III/2)	2.5 kV

Sample set - SAMPLE PTSM 0,5/ 3-HHI-2,5-SMD - 1820725

Technical data

General

Rated surge voltage (II/2)	2.5 kV
Rated voltage (III/3)	63 V
Rated voltage (III/2)	160 V
Rated voltage (II/2)	160 V
Nominal current I_N	6 A
Maximum load current	6 A
Insulating material	LCP
Flammability rating according to UL 94	V0
Color	black
Number of positions	3

Standards and Regulations

Flammability rating according to UL 94	V0
--	----

Environmental Product Compliance

China RoHS	Environmentally friendly use period: unlimited = EFUP-e
	No hazardous substances above threshold values

Drawings

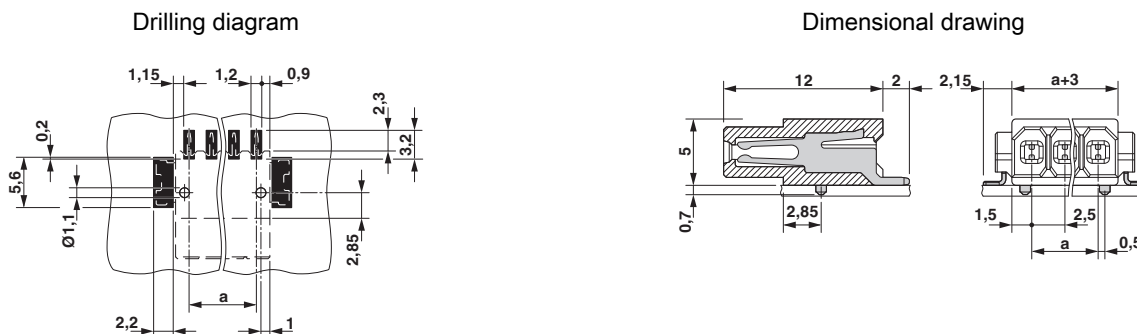

Classifications

eCl@ss

eCl@ss 4.0	272607xx
eCl@ss 4.1	27260701
eCl@ss 5.0	27260701
eCl@ss 5.1	27141190
eCl@ss 6.0	27260704
eCl@ss 7.0	27440402
eCl@ss 8.0	27440402
eCl@ss 9.0	27440402

Sample set - SAMPLE PTSM 0,5/ 3-HHI-2,5-SMD - 1820725

Classifications

ETIM

ETIM 3.0	EC001121
ETIM 4.0	EC002498
ETIM 5.0	EC002637
ETIM 6.0	EC002637

UNSPSC

UNSPSC 6.01	30211810
UNSPSC 7.0901	39121409
UNSPSC 11	39121409
UNSPSC 12.01	39121409
UNSPSC 13.2	39121409

Approvals

Approvals

Approvals

EAC

Ex Approvals

Approval details

EAC		B.01742
-----	--	---------

Accessories

Additional products

Base strip - PTSM 0,5/ 3-HHI-2,5-SMD R44 - 1810722



Header, Nominal current: 6 A, Rated voltage (III/2): 160 V, Number of positions: 3, Pitch: 2.5 mm, Color: black, Contact surface: Tin, Mounting: SMD soldering, Article with anti-rotation pin