

Product information

RKMWV - RKMWV 4-225/2 M

Industrial Connecting Solutions: Circular Connectors: M8 - M12 Connectors: M8 Connectors: Overmolded single ended M8 cord sets: female connector: Standard Types, with threaded joint or snap-in joint: RKMWV

https://e-catalog.hirschmann.com:443/link/57078-24228-256281-256292-256303-250524-250526-250528-251241/en/RKMWV4_225_0200/uistate

Name	RKMWV
	
	Cordsets, single-ended, for actuator/sensors and distribution boxes, M8 female connector, angled, with self-locking threaded joint and molded cable, 4 poles, PUR jacket, halogen free, black, 2 meters.
Delivery informations	
Availability	available
Product description	
Type	RKMWV 4-225/2 M
Order No.	28382
Description	Cordsets, single-ended, for actuator/sensors and distribution boxes, M8 female connector, angled, with self-locking threaded joint and molded cable, 4 poles, PUR jacket, halogen free, black, 2 meters.
Note	The application of these products in harsh environments should always be checked before use.
Number of contacts	4
Color of housing	black translucent
Product characteristics	Vibration resistance, Drag chains, Oil resistance
Classification	
Belden brand	Lumberg-Automation
Mechanical data	
Type of plug-in contact	Female connector
Design of housing	angled
Thread	M8
Design of electrical connection	connector M8
LED display present	✘
Environmental conditions	
Environmental temperature	-40 °C ... 90 °C
Degree of protection (IP), mounted	IP67 / IP69K
Pollution degree	3
Materials	
Housing material / Molded body	TPU
Contact bearer material	PA/TPU
Contact material	CuZn
Contact material - Surface refinement	pre-nickelated and 0.8 microns gold-plated
Knurled screw / nut material	CuZn, nickel-plated
Sealing material	FKM
Electrical data	
Contact resistance	≤ 5 mΩ
Rated current I _n	4 A at 40°C
Nominal voltage	30 V
Rated voltage	36 V
Test voltage	0.8 kV eff./60 s
Insulation resistance	> 1 GΩ
Approvals	
Approvals	UL
Cable	
Cable length	2 m

Industrial Connecting Solutions: Circular Connectors: M8 - M12 Connectors: M8 Connectors: Overmolded single ended M8 cord sets: female connector: Standard Types, with threaded joint or snap-in joint: RKMVV

https://e-catalog.hirschmann.com:443/link/57078-24228-256281-256292-256303-250524-250526-250528-251241/en/RKMVV4_225_0200/uisstate

Cable number	225
Cable description	Cable for sensors and actuators
Color of jacket	black
Material of outer jacket	PUR
Without halogens as in EN 50267-2-3	✓
shielded	✗
welding spark proof	✗
Outer diameter of the cable	4.7 mm
Number of conductors	4
Cable design	4 x 0.34 mm ²
Conductor design	43 x 0.10 mm
Flame resistant according to standard	yes

Picture

Drawing

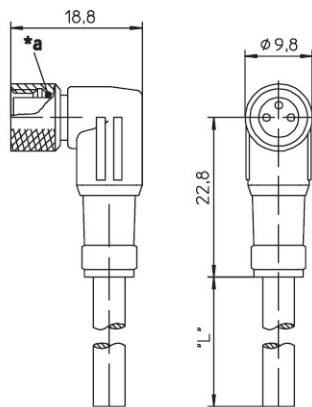

*a O-Ring
O-ring

**4-polig
4 poles**



- 1 = braun / brown
- 2 = weiß / white
- 3 = blau / blue
- 4 = schwarz / black

Belden Deutschland GmbH
 Im Gewerbepark 2
 58579 Schalksmühle
 Germany
 Phone: +49 7127/14-1806
 E-Mail: icos-sales@belden.com

The information published in the websites has been compiled as carefully as possible. It is subject to alteration without notice in technical as well as in price-related/commercial respect. The complete information and data were available on user documentation. Mandatory information can only be obtained by a concrete query.