



## Features

- Single device for two I/O lines
- Low capacitance for high-speed CANbus
- IEC 61000-4-2 30 kV ESD
- IEC 61000-4-5 (Level 1, CWG 1.2/50) 500 V Surge
- RoHS compliant\*

## Applications

- High-speed CANbus
- Industrial control networks
- Smart Distribution Systems (SDS)
- DeviceNet™
- Factory and process automation systems
- Lift control systems

# CDSOT23-T24CAN CANbus Protector

## General Information

The Model CDSOT23-T24CAN device is designed to provide ESD and surge protection for CAN transceivers, meeting IEC 61000-4-2 (ESD) and IEC 61000-4-5 (Surge) requirements. The dual TVS array protects both data lines, offers a Working Reverse Voltage of 24 V and a Minimum Breakdown Voltage of 26.2 V and can be used with transceivers with internal circuitry for 24 V power supply miswiring. The low capacitance and low leakage current of the Model CDSOT23-T24CAN minimizes impact on signal integrity and is compatible with high-speed CAN.

The SOT-23 packaged device conforms to JEDEC standards and will mount directly onto the industry standard SOT-23 footprint. Its compact size eases layout on compact PCB designs while ensuring compliance with stringent EMI requirements.

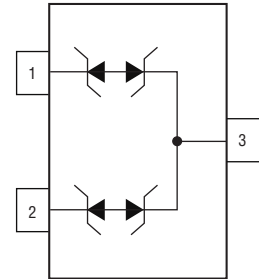

## Absolute Maximum Ratings (@ T<sub>A</sub> = 25 °C Unless Otherwise Noted)

Rating	Symbol	Value	Unit
Repetitive Peak Off-state Voltage	V <sub>DRM</sub>	24	V
Non-Repetitive Peak Impulse Current, 8/20 μs Waveform	I <sub>PPSM</sub>	8	A
Non-Repetitive Peak Impulse Current, 1.2/50 μs Waveform	I <sub>PPSM</sub>	6	A
ESD (IEC 61000-4-2 Contact)		30	kV
Junction Temperature	T <sub>J</sub>	-40 to +150	°C
Storage Temperature	T <sub>stg</sub>	-55 to +150	°C

## Electrical Characteristics (@ T<sub>A</sub> = 25 °C Unless Otherwise Noted)

Parameter		Test Condition	Min.	Typ.	Max.	Unit
I <sub>D</sub>	Leakage Current	V <sub>D</sub> = V <sub>DRM</sub>			100	nA
V <sub>BR</sub>	Breakdown Voltage	I <sub>BR</sub> = 1 mA	26.2		32	V
V <sub>C</sub>	Clamping Voltage	I = 5 A 8/20 μs waveform		36		V
V <sub>C</sub>	Clamping voltage	I = 8 A 8/20 μs waveform		40		V
C	Capacitance	V <sub>D</sub> = 0 V, f = 1 MHz V <sub>osc</sub> = 1 V <sub>rms</sub>	Line to GND (Pin 1-3 or Pin 2-3)	22	30	pF
			Line to Line (Pin 1-2)	11		



**WARNING Cancer and Reproductive Harm - [www.P65Warnings.ca.gov](http://www.P65Warnings.ca.gov)**

DeviceNet™ is a trademark of ODVA.

\*RoHS Directive 2015/863, Mar 31, 2015 and Annex.

Specifications are subject to change without notice.

Users should verify actual device performance in their specific applications.

The products described herein and this document are subject to specific legal disclaimers as set forth on the last page of this document, and at [www.bourns.com/docs/legal/disclaimer.pdf](http://www.bourns.com/docs/legal/disclaimer.pdf).

## Rating & Characteristic Curves

### 8/20 $\mu$ s Pulse Waveform

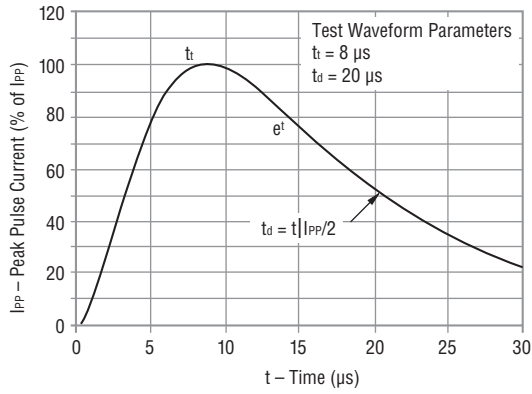

### Clamping Voltage vs. Peak Pulse Current

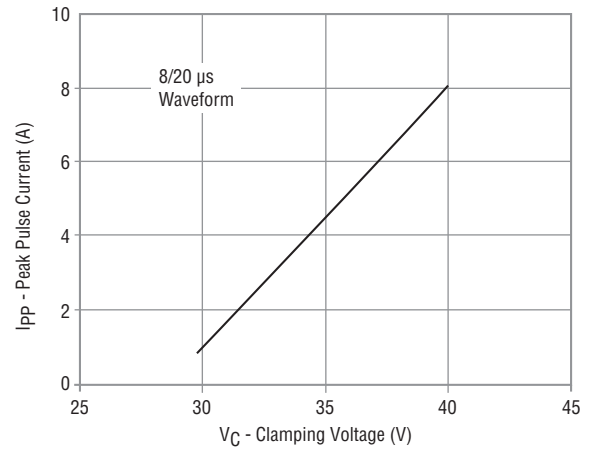

### Leakage Current vs. Temperature

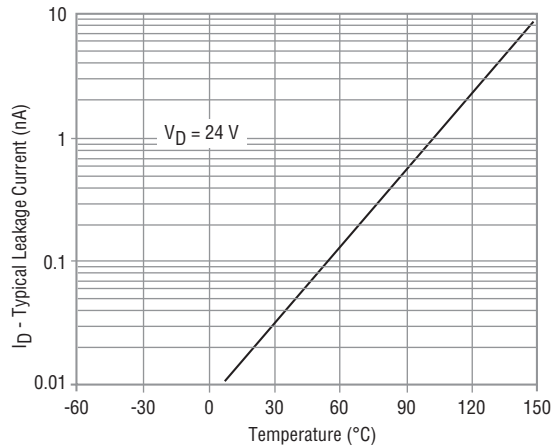

### Breakdown Voltage vs. Temperature

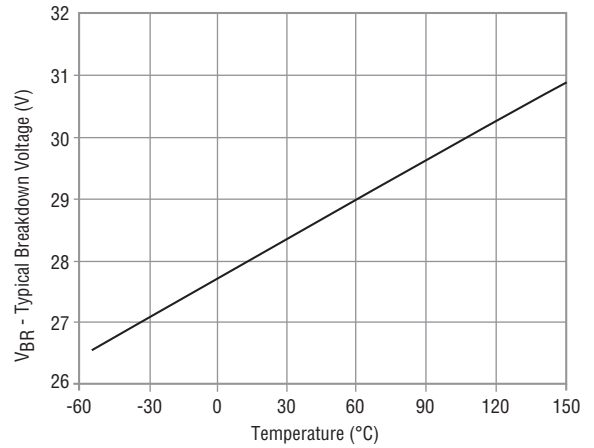

# CDSOT23-T24CAN CANbus Protector

**BOURNS®**

## Application Information

The Model CDSOT23-T24CAN dual TVS diode array is designed to protect a CANbus transceiver against surge events per IEC 61000-4-5 (Level 1), and also increase the resistibility against ESD events beyond IEC 61000-4-2 to as high as 30 kV. It is intended to be used with a transceiver that has internal protection against other faults such as 24 V power supply miswiring. The Model CDSOT23-T24CAN is designed with a minimum breakdown voltage of 26.2 V so that it will not conduct during a 24 VDC power cross event.

The surge test setup below shows the differential input/output (I/O) of a typical transceiver, its termination network, being protected by the CDSOT23-T24CAN device. The 1.2/50  $\mu$ s voltage, 8/20  $\mu$ s current combination wave generator is connected to the circuit through two 80 ohm resistors and a coupling device (CD). This circuit was subjected to a 500 V (1.2/50) longitudinal surge (common mode) in both positive and negative polarities per IEC 61000-4-5 (Level 1). The oscilloscope traces in Figures 1 and 2 show the clamp voltage with respect to ground for the CAN H and CAN L signal lines, as well as the total surge current output from the surge generator into the circuit, for each of these surges. The peak current on each line is ~ 5.5 A (11 A total/2 lines) when subjected to the 500 V (1.2/50) surge. The TVS diode clamps the voltage at the I/O of the transceiver within 37 V during the surge.

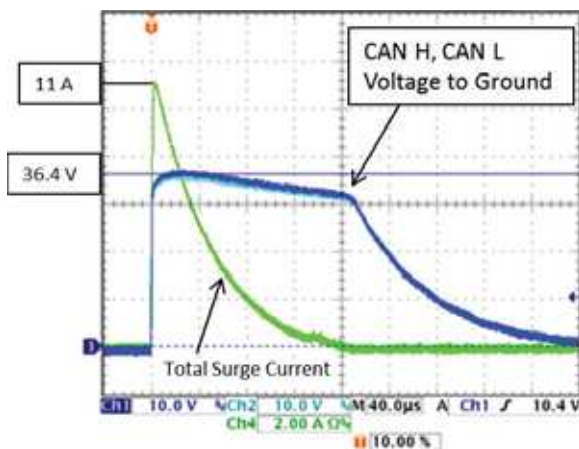
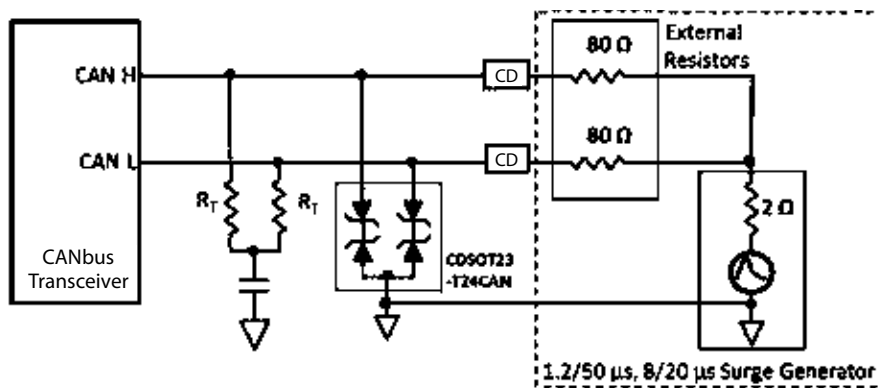

Figure 1 -

CDSOT23-T24CAN Clamp Voltages for a +500 V Surge

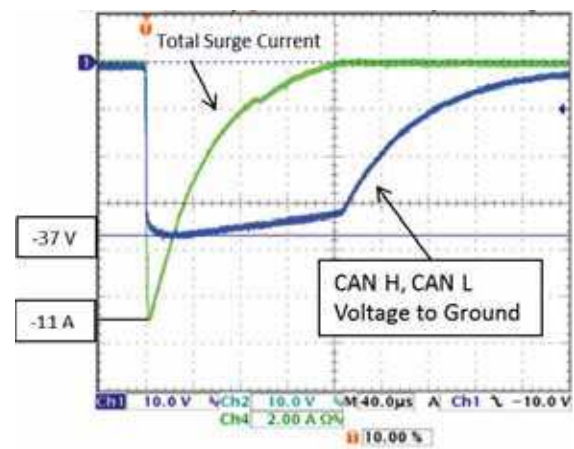

Figure 2 -

CDSOT23-T24CAN Clamp Voltages for a -500 V Surge

Specifications are subject to change without notice.

Users should verify actual device performance in their specific applications.

The products described herein and this document are subject to specific legal disclaimers as set forth on the last page of this document, and at [www.bourns.com/docs/legal/disclaimer.pdf](http://www.bourns.com/docs/legal/disclaimer.pdf).

# CDSOT23-T24CAN CANbus Protector

**BOURNS®**

## Layout Considerations

The figure below shows an example of how the Model CDSOT23-T24CAN can be connected on a two-sided PCB design. The device should be placed as close to the bus connector as possible with short traces to the signal lines. Since the connector pin spacing is generally much larger than the pin spacing of the transceiver, it is relatively easy to do this. A standard 10 mil, 1 ounce copper trace is more than adequate to handle the peak current level from the 500 V surge discussed in the previous section. The ground pin of the device should be connected to the circuit board ground plane using a short trace and a via. If there is a ground plane on the signal side of the circuit board near where the diode array is placed, it should be connected directly to it.

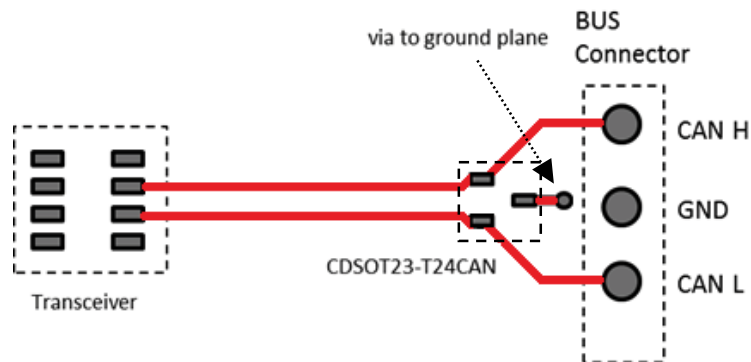

## Typical Part Marking

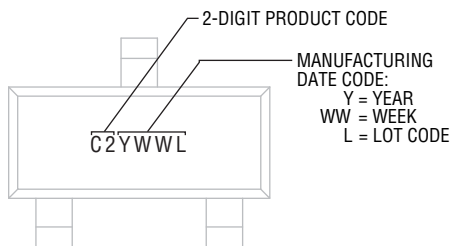

## Environmental Specifications

Moisture Sensitivity Level.....	1
ESD Classification (HBM).....	3B

Specifications are subject to change without notice.

Users should verify actual device performance in their specific applications.

The products described herein and this document are subject to specific legal disclaimers as set forth on the last page of this document, and at [www.bourns.com/docs/legal/disclaimer.pdf](http://www.bourns.com/docs/legal/disclaimer.pdf).

# CDSOT23-T24CAN CANbus Protector

**BOURNS®**

## Product Dimensions

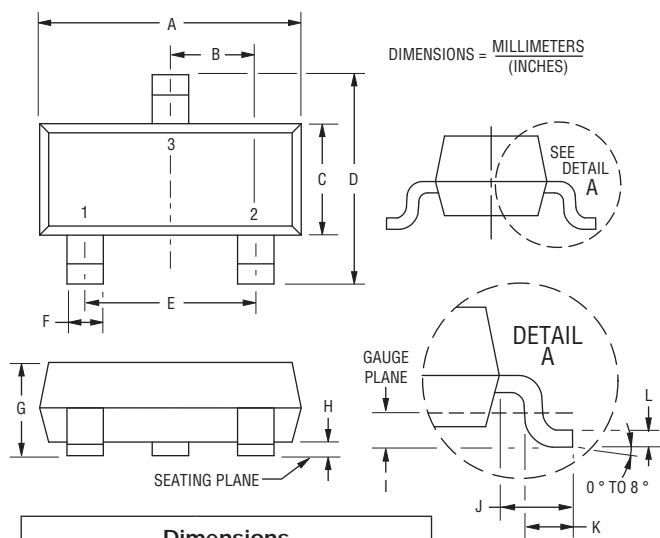

**Dimensions**

A	$\frac{2.80 - 3.00}{(0.110 - 0.118)}$
B	$\frac{0.95}{(0.037)}$ BSC
C	$\frac{1.20 - 1.40}{(0.047 - 0.055)}$
D	$\frac{2.10 - 2.49}{(0.083 - 0.098)}$
E	$\frac{1.90}{(0.075)}$ BSC
F	$\frac{0.30 - 0.50}{(0.012 - 0.019)}$
G	$\frac{0.89 - 1.17}{(0.035 - 0.046)}$
H	$\frac{0.05 - 0.15}{(0.002 - 0.006)}$
I	$\frac{0.25}{(0.010)}$ BSC
J	$\frac{0.46 - 0.64}{(0.018 - 0.025)}$
K	$\frac{0.40 - 0.58}{(0.016 - 0.023)}$
L	$\frac{0.08 - 0.20}{(0.003 - 0.008)}$

## Recommended Footprint

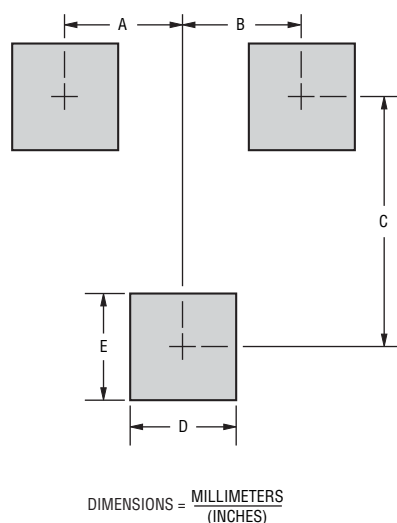

**Dimensions**

A	$\frac{0.95}{(0.037)}$
B	$\frac{0.95}{(0.037)}$
C	$\frac{2.00}{(0.079)}$
D	$\frac{0.85}{(0.033)}$
E	$\frac{0.85}{(0.033)}$

## How to Order

**CD SOT23 - T 24 CAN**

Common Code \_\_\_\_\_  
 Chip Diode

Package \_\_\_\_\_  
 SOT23 = SOT-23-3L Package

Model \_\_\_\_\_  
 T = Transient Voltage Suppressor

Working Reverse Voltage \_\_\_\_\_  
 24 = 24 V

Suffix \_\_\_\_\_  
 CAN = CANbus Protector

Specifications are subject to change without notice.

Users should verify actual device performance in their specific applications.

The products described herein and this document are subject to specific legal disclaimers as set forth on the last page of this document, and at [www.bourns.com/docs/legal/disclaimer.pdf](http://www.bourns.com/docs/legal/disclaimer.pdf).

# CDSOT23-T24CAN CANbus Protector

**BOURNS®**

## Packaging Information

The product is dispensed in tape and reel format (see diagram below).

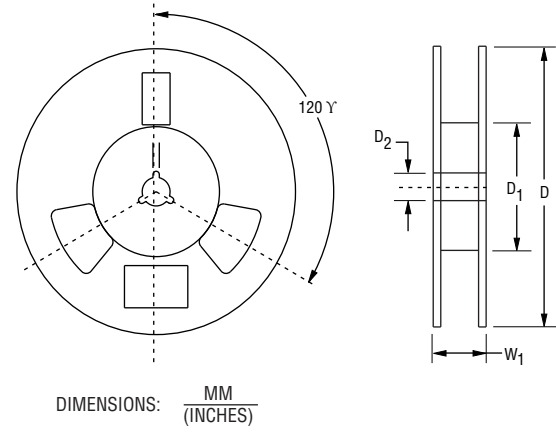
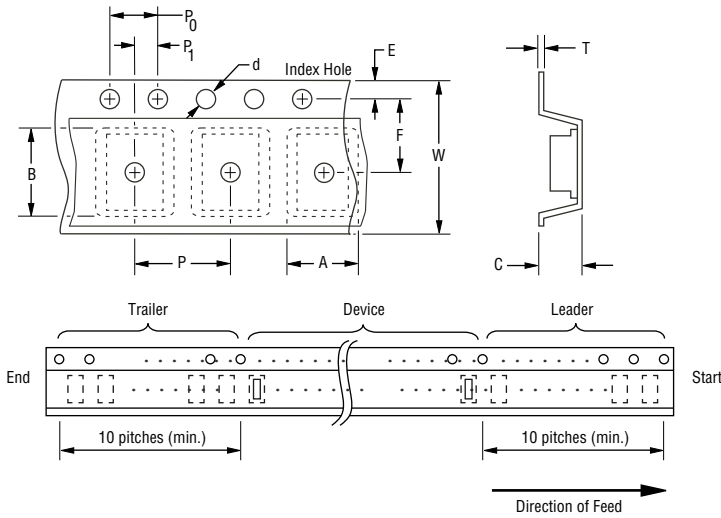

Devices are packed in accordance with EIA standard RS-481-A.

Item	Symbol	SOT-23
Carrier Width	A	$\frac{2.25 \pm 0.10}{(0.088 - 0.004)}$
Carrier Length	B	$\frac{2.34 \pm 0.10}{(0.092 - 0.004)}$
Carrier Depth	C	$\frac{1.22 \pm 0.10}{(0.048 - 0.004)}$
Sprocket Hole	d	$\frac{1.55 \pm 0.05}{(0.061 - 0.002)}$
Reel Outside Diameter	D	$\frac{178}{(7.008)}$
Reel Inner Diameter	D <sub>1</sub>	$\frac{50.0}{(1.969)}$ Min.
Feed Hole Diameter	D <sub>2</sub>	$\frac{13.0 \pm 0.20}{(0.512 \pm 0.008)}$
Sprocket Hole Position	E	$\frac{1.75 \pm 0.10}{(0.069 \pm 0.004)}$
Punch Hole Position	F	$\frac{3.50 \pm 0.05}{(0.138 \pm 0.002)}$
Punch Hole Pitch	P	$\frac{4.00 \pm 0.10}{(0.157 - 0.004)}$
Sprocket Hole Pitch	P <sub>0</sub>	$\frac{4.00 \pm 0.10}{(0.157 \pm 0.004)}$
Embossment Center	P <sub>1</sub>	$\frac{2.00 \pm 0.05}{(0.079 \pm 0.002)}$
Overall Tape Thickness	T	$\frac{0.20 \pm 0.10}{(0.008 \pm 0.004)}$
Tape Width	W	$\frac{8.00 \pm 0.20}{(0.315 - 0.008)}$
Reel Width	W <sub>1</sub>	$\frac{14.4}{(0.567)}$ Max.
Quantity per Reel	--	3,000

**BOURNS®**

**Asia-Pacific:**  
Tel: +886-2 2562-4117  
Email: asiacus@bourns.com

**Europe:**  
Tel: +36 88 885 877  
Email: eurocus@bourns.com

**The Americas:**  
Tel: +1-951 781-5500  
Email: americus@bourns.com  
[www.bourns.com](http://www.bourns.com)

REV. 08/19  
Specifications are subject to change without notice.  
Users should verify actual device performance in their specific applications.  
The products described herein and this document are subject to specific legal disclaimers as set forth on the last page of this document, and at [www.bourns.com/docs/legal/disclaimer.pdf](http://www.bourns.com/docs/legal/disclaimer.pdf).

This legal disclaimer applies to purchasers and users of Bourns® products manufactured by or on behalf of Bourns, Inc. and its affiliates (collectively, “Bourns”).

Unless otherwise expressly indicated in writing, Bourns® products and data sheets relating thereto are subject to change without notice. Users should check for and obtain the latest relevant information and verify that such information is current and complete before placing orders for Bourns® products.

The characteristics and parameters of a Bourns® product set forth in its data sheet are based on laboratory conditions, and statements regarding the suitability of products for certain types of applications are based on Bourns’ knowledge of typical requirements in generic applications. The characteristics and parameters of a Bourns® product in a user application may vary from the data sheet characteristics and parameters due to (i) the combination of the Bourns® product with other components in the user’s application, or (ii) the environment of the user application itself. The characteristics and parameters of a Bourns® product also can and do vary in different applications and actual performance may vary over time. Users should always verify the actual performance of the Bourns® product in their specific devices and applications, and make their own independent judgments regarding the amount of additional test margin to design into their device or application to compensate for differences between laboratory and real world conditions.

Unless Bourns has explicitly designated an individual Bourns® product as meeting the requirements of a particular industry standard (e.g., ISO/TS 16949) or a particular qualification (e.g., UL listed or recognized), Bourns is not responsible for any failure of an individual Bourns® product to meet the requirements of such industry standard or particular qualification. Users of Bourns® products are responsible for ensuring compliance with safety-related requirements and standards applicable to their devices or applications.

Bourns® products are not recommended, authorized or intended for use in nuclear, lifesaving, life-critical or life-sustaining applications, nor in any other applications where failure or malfunction may result in personal injury, death, or severe property or environmental damage. Unless expressly and specifically approved in writing by two authorized Bourns representatives on a case-by-case basis, use of any Bourns® products in such unauthorized applications might not be safe and thus is at the user’s sole risk. Life-critical applications include devices identified by the U.S. Food and Drug Administration as Class III devices and generally equivalent classifications outside of the United States.

Bourns expressly identifies those Bourns® standard products that are suitable for use in automotive applications on such products’ data sheets in the section entitled “Applications.” Unless expressly and specifically approved in writing by two authorized Bourns representatives on a case-by-case basis, use of any other Bourns® standard products in an automotive application might not be safe and thus is not recommended, authorized or intended and is at the user’s sole risk. If Bourns expressly identifies a sub-category of automotive application in the data sheet for its standard products (such as infotainment or lighting), such identification means that Bourns has reviewed its standard product and has determined that if such Bourns® standard product is considered for potential use in automotive applications, it should only be used in such sub-category of automotive applications. Any reference to Bourns® standard product in the data sheet as compliant with the AEC-Q standard or “automotive grade” does not by itself mean that Bourns has approved such product for use in an automotive application.

Bourns® standard products are not tested to comply with United States Federal Aviation Administration standards generally or any other generally equivalent governmental organization standard applicable to products designed or manufactured for use in aircraft or space applications. Bourns expressly identifies Bourns® standard products that are suitable for use in aircraft or space applications on such products’ data sheets in the section entitled “Applications.” Unless expressly and specifically approved in writing by two authorized Bourns representatives on a case-by-case basis, use of any other Bourns® standard product in an aircraft or space application might not be safe and thus is not recommended, authorized or intended and is at the user’s sole risk.

The use and level of testing applicable to Bourns® custom products shall be negotiated on a case-by-case basis by Bourns and the user for which such Bourns® custom products are specially designed. Absent a written agreement between Bourns and the user regarding the use and level of such testing, the above provisions applicable to Bourns® standard products shall also apply to such Bourns® custom products.

Users shall not sell, transfer, export or re-export any Bourns® products or technology for use in activities which involve the design, development, production, use or stockpiling of nuclear, chemical or biological weapons or missiles, nor shall they use Bourns® products or technology in any facility which engages in activities relating to such devices. The foregoing restrictions apply to all uses and applications that violate national or international prohibitions, including embargos or international regulations. Further, Bourns® products and Bourns technology and technical data may not under any circumstance be exported or re-exported to countries subject to international sanctions or embargoes. Bourns® products may not, without prior authorization from Bourns and/or the U.S. Government, be resold, transferred, or re-exported to any party not eligible to receive U.S. commodities, software, and technical data.

To the maximum extent permitted by applicable law, Bourns disclaims (i) any and all liability for special, punitive, consequential, incidental or indirect damages or lost revenues or lost profits, and (ii) any and all implied warranties, including implied warranties of fitness for particular purpose, non-infringement and merchantability.

*For your convenience, copies of this Legal Disclaimer Notice with German, Spanish, Japanese, Traditional Chinese and Simplified Chinese bilingual versions are available at:*

*Web Page:* <http://www.bourns.com/legal/disclaimers-terms-and-policies>

*PDF:* <http://www.bourns.com/docs/Legal/disclaimer.pdf>