

EMI Filter for T-Flash / MicroSD Interfaces

CM1624

Description

The CM1624 is a combination EMI filter and line termination device with integrated TVS diodes for use on Multimedia Card interfaces. This state-of-the-art device utilizes solid-state, silicon-avalanche technology for superior clamping performance and DC electrical characteristics. The CM1624 has been optimized for protection of T-Flash/MicroSD interfaces in cellular phones and other portable electronics.

The CM1624 consists of six circuits that includes series impedance matching resistors and pull-up resistors as required by the SD specification. TVS diodes are included on each line for ESD protection. An additional TVS diode connection is included for protection of the voltage (Vcc) bus. Termination resistor value of 40 Ω is provided on the SDData0, SDData1, SDData2, SDData3, CMD, and CLK lines.

Pull-up resistors of 25 kΩ are included on the SDData0, SDData1, SDData2, SDData3 and CMD lines, as well. These may be configured for devices operating in SD or SPI mode. The TVS diodes provide effective suppression of ESD voltages in excess of ±15 kV (contact discharge) per IEC 61000-4-2, level 4. The CM1624 is in a 16-pin, RoHS/WEEE compliant, UDFN 16-pin package. It measures 3.30 x 1.35 x 0.50 mm. The leads are spaced at a pitch of 0.4 mm and are finished with lead-free NiPd.

Features

- Bidirectional EMI/RFI Filtering and Line Termination with Integrated ESD Protection
- Provides ESD Protection to IEC61000-4-2: ±15 kV Contact Discharge
- TVS Working Voltage: 5 V
- Termination Resistors: 40 Ω
- Pull-up Resistors: 25 kΩ
- Typical Capacitance per Line: 12 pF ($V_{IN} = 2.5$ V)
- Protection and Termination for Six Lines + Vcc
- Solid-state Technology

Applications

- T-Flash / MicroSD Interfaces
- MMC Interfaces
- CDMA, GSM, 3G Cell Phones

Mechanical Characteristics

- 0.40 mm, uDFN 16-pin Package
- Nominal Dimensions: 3.30 x 1.35 x 0.50 mm
- Pitch: 0.4 mm
- Pin-lead Finish: NiPd
- RoHS/WEEE Compliance, Lead-free Finish



ON Semiconductor®

www.onsemi.com

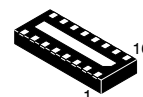

UDFN16
DE SUFFIX
CASE 517BE

MARKING DIAGRAM

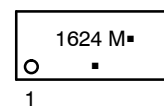

- 1624 = Specific Device Code
- M = Single Character Date Code
- = Pb-Free Package

(Note: Microdot may be in either location)

PINOUT DIAGRAM

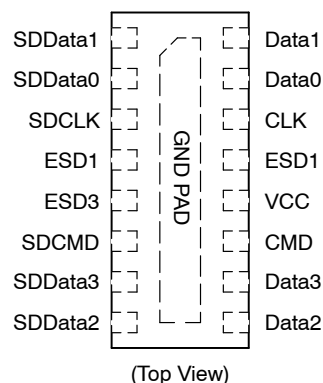

ORDERING INFORMATION

Device	Package	Shipping†
CM1624-08DE	UDFN16 (Pb-Free)	3000/Tape & Reel

†For information on tape and reel specifications, including part orientation and tape sizes, please refer to our Tape and Reel Packaging Specification Brochure, BRD8011/D.

CM1624

ELECTRICAL SCHEMATIC

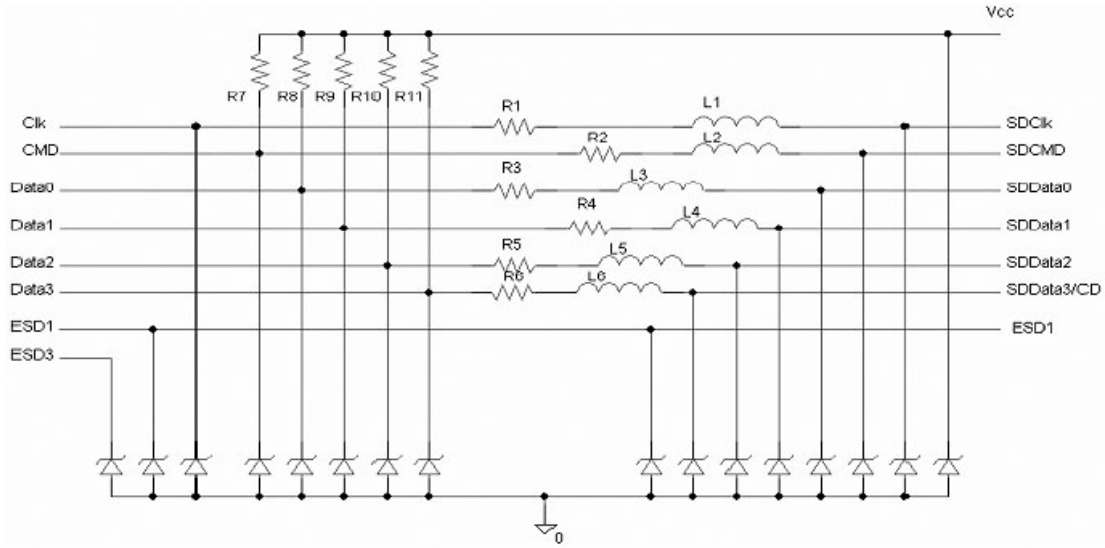

Table 1. PIN DESCRIPTIONS

Pin	Name	Description
1	SDData1	Data line #1 input/output with pull-up resistor
2	SDData0	Data line #0 input/output with pull-up resistor
3	SDCLK	Clock line Input/Output
4	ESD1	Single ESD
5	ESD3	Single ESD
6	SDCMD	Command Line Input/Output
7	SDData3	Data line #3 input/output with pull-up resistor
8	SDData2	Data line #2 input/output with pull-up resistor
9	Data2	Data line #2 input/output with pull-up resistor
10	Data3	Data line #3 input/output with pull-up resistor
11	CMD	Command Line Input/Output
12	VCC	Power Supply ESD Protection
13	ESD1	Single ESD
14	CLK	Clock line Input/Output
15	Data0	Data line #0 input/output with pull-up resistor
16	Data1	Data line #1 input/output with pull-up resistor
GND PAD	GND	Ground return to shield

CM1624

SPECIFICATIONS

Table 2. ABSOLUTE MAXIMUM RATINGS

Parameter	Rating	Units
Operating Temperature Range	-40 to +85	°C
Storage Temperature Range	-55 to +150	°C

Stresses exceeding those listed in the Maximum Ratings table may damage the device. If any of these limits are exceeded, device functionality should not be assumed, damage may occur and reliability may be affected.

Table 3. ELECTRICAL OPERATING CHARACTERISTICS (Note 1)

Symbol	Parameter	Conditions	Min	Typ	Max	Units
R _{CH}	Channel Resistance (R1 to R6)		34	40	46	Ω
L _{CH}	Channel Inductance			20		nH
C	Capacitance per Channel	V _{IN} = 0 V; 1 MHz; 30 mV _{RMS} (Note 2)	16	20	24	pF
		V _{IN} = 2.5 V; 1 MHz; 30 mV _{RMS} (Note 2)		12		pF
R _{UP}	Pull-up Resistance (R7 to R11)		21	25	29	kΩ
I _{LEAK}	Diode Leakage Current per Channel	V _{IN} = 3 V		0.1	0.5	μA
V _{SIG}	Signal Clamp Voltage Positive Clamp Negative Clamp	I _{LOAD} = 10 mA	5.6	6.8	9.0	V
		I _{LOAD} = -10 mA	-1.5	-0.8	-0.4	
V _{ESD}	ESD Protection – Peak Discharge Voltage at any channel input, in system: a) Contact discharge per IEC 61000-4-2 Standard and b) Air discharge per IEC 61000-4-2 Standard	(Note 2)	±15			kV
		(Note 2)	±15			
f _C	Cut-off frequency Z _{SOURCE} = 50 Ω, Z _{LOAD} = 50 Ω			300		MHz

Product parametric performance is indicated in the Electrical Characteristics for the listed test conditions, unless otherwise noted. Product performance may not be indicated by the Electrical Characteristics if operated under different conditions.

1. All parameters specified at T_A = 25°C unless otherwise noted.
2. This parameter is guaranteed by design and verified by device characterization

CM1624

PERFORMANCE INFORMATION

Typical Filter Performance (nominal conditions unless specified otherwise, 50 Ω Environment)

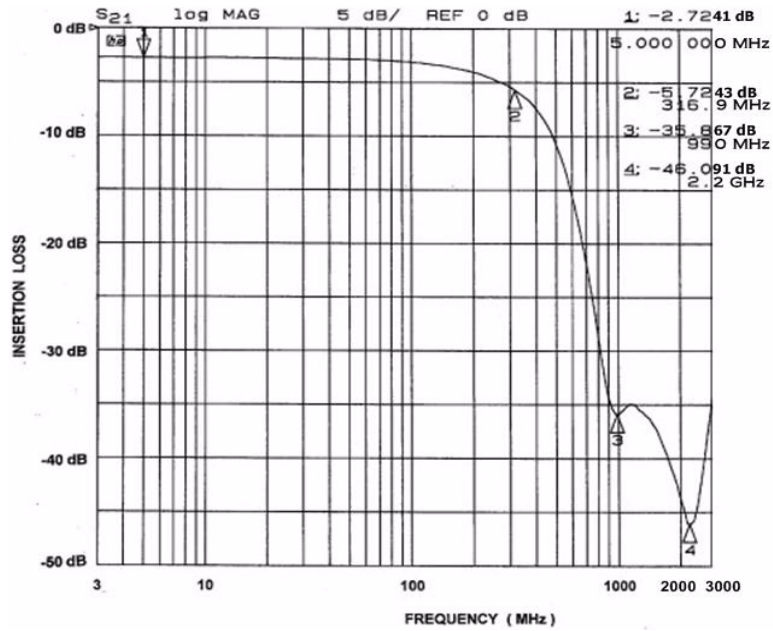

Figure 1. Insertion Loss vs. Frequency (Pins 1 and 16)

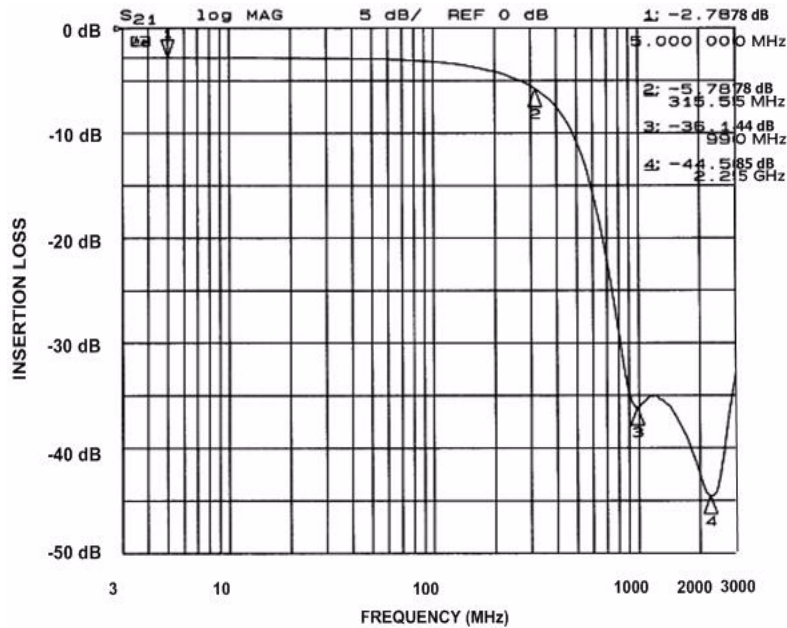

Figure 2. Insertion Loss vs. Frequency (Pins 2 and 15)

CM1624

PERFORMANCE INFORMATION (cont'd)

Typical Filter Performance (nominal conditions unless specified otherwise, 50 Ω Environment)

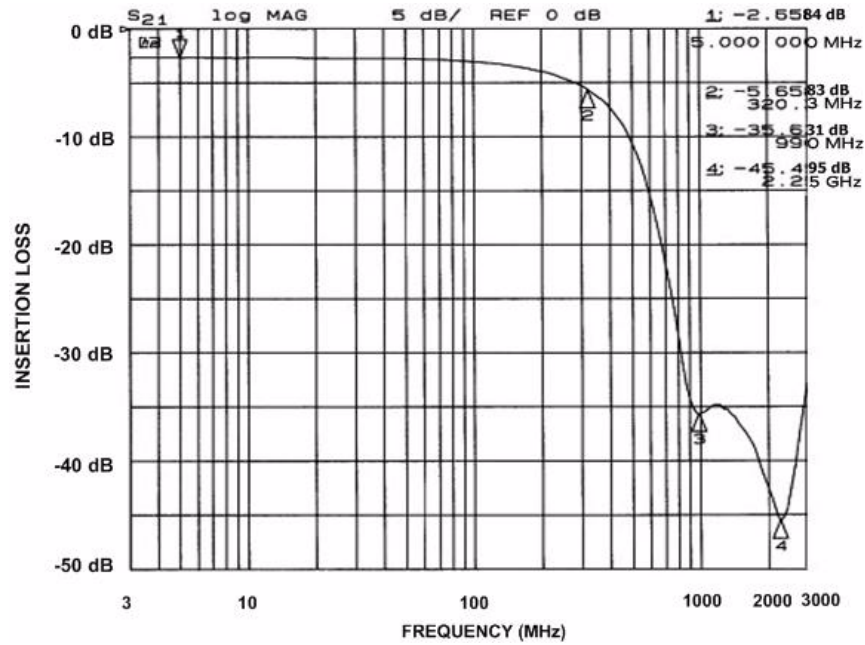

Figure 3. Insertion Loss vs. Frequency (Pins 3 and 14)

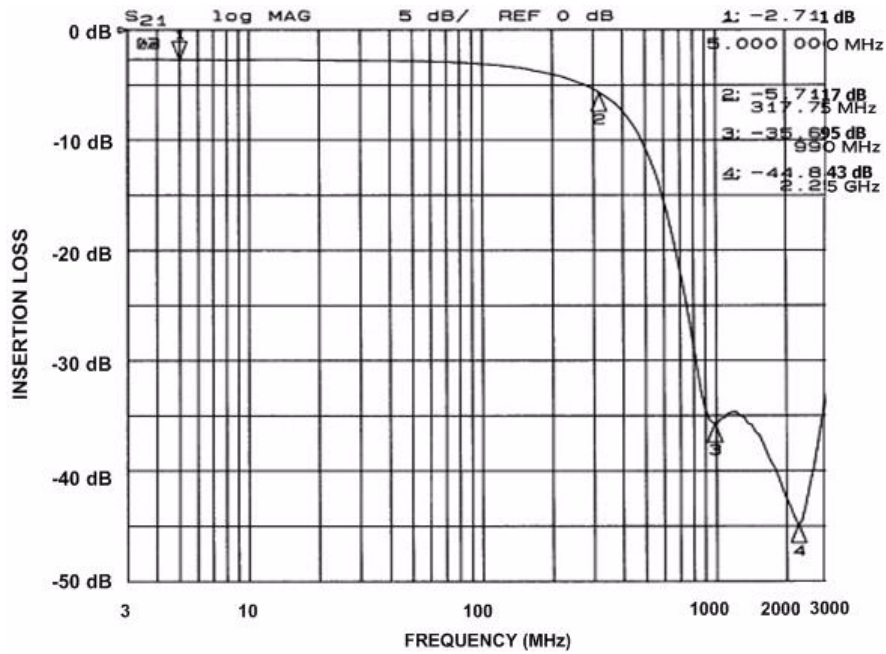

Figure 4. Insertion Loss vs. Frequency (Pins 6 and 11)

CM1624

PERFORMANCE INFORMATION (cont'd)

Typical Filter Performance (nominal conditions unless specified otherwise, 50 Ω Environment)

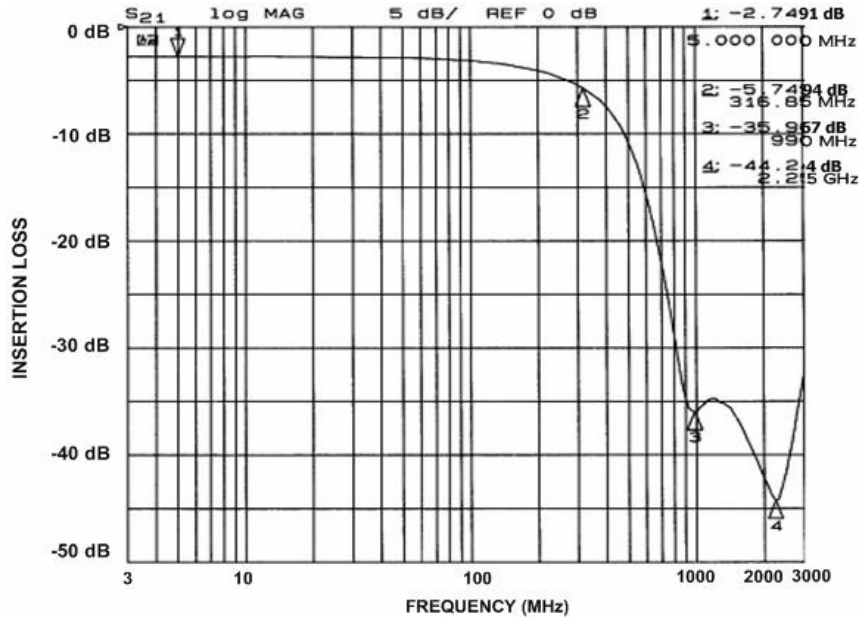

Figure 5. Insertion Loss vs. Frequency (Pins 7 and 10)

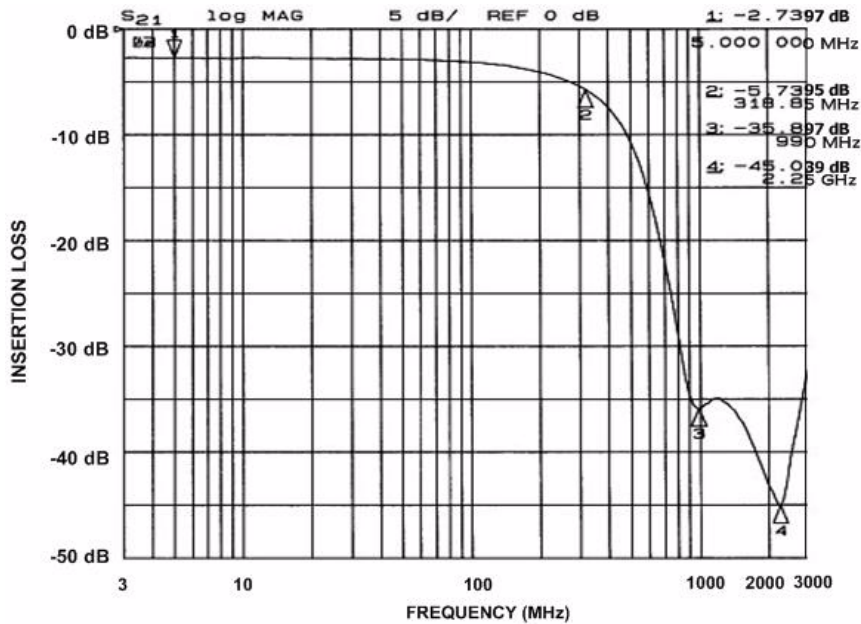
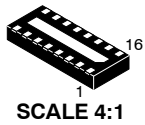

Figure 6. Insertion Loss vs. Frequency (Pins 8 and 9)

MECHANICAL CASE OUTLINE

PACKAGE DIMENSIONS

ON Semiconductor®



UDFN16, 3.3x1.35, 0.4P
CASE 517BE-01
ISSUE O

DATE 18 NOV 2009

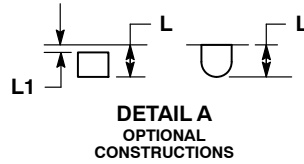

- NOTES:
1. DIMENSIONING AND TOLERANCING PER ASME Y14.5M, 1994.
 2. CONTROLLING DIMENSION: MILLIMETERS.
 3. DIMENSION b APPLIES TO PLATED TERMINAL AND IS MEASURED BETWEEN 0.15 AND 0.25 mm FROM THE TERMINAL TIP.
 4. COPLANARITY APPLIES TO THE EXPOSED PAD AS WELL AS THE TERMINALS.



MILLIMETERS		
DIM	MIN	MAX
A	0.45	0.55
A1	0.00	0.05
A3	0.13	REF
b	0.15	0.25
D	3.30	BSC
D2	2.70	2.90
E	1.35	BSC
E2	0.30	0.50
e	0.40	BSC
K	0.15	---
L	0.20	0.30
L1	---	0.05



GENERIC MARKING DIAGRAM*

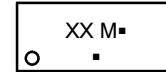

1

- XX = Specific Device Code
- M = Month Code
- = Pb-Free Package

(Note: Microdot may be in either location)

*This information is generic. Please refer to device data sheet for actual part marking.

Pb-Free indicator, "G" or microdot "▪", may or may not be present.

RECOMMENDED SOLDERING FOOTPRINT*

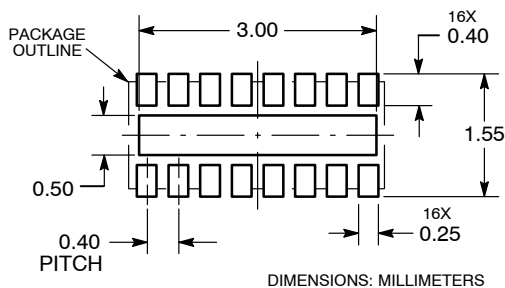

*For additional information on our Pb-Free strategy and soldering details, please download the ON Semiconductor Soldering and Mounting Techniques Reference Manual, SOLDERRM/D.

DOCUMENT NUMBER:	98AON47062E	Electronic versions are uncontrolled except when accessed directly from the Document Repository. Printed versions are uncontrolled except when stamped "CONTROLLED COPY" in red.
DESCRIPTION:	UDFN16, 3.3X1.35, 0.4P	PAGE 1 OF 1

ON Semiconductor and ON are trademarks of Semiconductor Components Industries, LLC dba ON Semiconductor or its subsidiaries in the United States and/or other countries. ON Semiconductor reserves the right to make changes without further notice to any products herein. ON Semiconductor makes no warranty, representation or guarantee regarding the suitability of its products for any particular purpose, nor does ON Semiconductor assume any liability arising out of the application or use of any product or circuit, and specifically disclaims any and all liability, including without limitation special, consequential or incidental damages. ON Semiconductor does not convey any license under its patent rights nor the rights of others.

onsemi, **Onsemi**, and other names, marks, and brands are registered and/or common law trademarks of Semiconductor Components Industries, LLC dba "**onsemi**" or its affiliates and/or subsidiaries in the United States and/or other countries. **onsemi** owns the rights to a number of patents, trademarks, copyrights, trade secrets, and other intellectual property. A listing of **onsemi**'s product/patent coverage may be accessed at www.onsemi.com/site/pdf/Patent-Marking.pdf. **onsemi** reserves the right to make changes at any time to any products or information herein, without notice. The information herein is provided "as-is" and **onsemi** makes no warranty, representation or guarantee regarding the accuracy of the information, product features, availability, functionality, or suitability of its products for any particular purpose, nor does **onsemi** assume any liability arising out of the application or use of any product or circuit, and specifically disclaims any and all liability, including without limitation special, consequential or incidental damages. Buyer is responsible for its products and applications using **onsemi** products, including compliance with all laws, regulations and safety requirements or standards, regardless of any support or applications information provided by **onsemi**. "Typical" parameters which may be provided in **onsemi** data sheets and/or specifications can and do vary in different applications and actual performance may vary over time. All operating parameters, including "Typicals" must be validated for each customer application by customer's technical experts. **onsemi** does not convey any license under any of its intellectual property rights nor the rights of others. **onsemi** products are not designed, intended, or authorized for use as a critical component in life support systems or any FDA Class 3 medical devices or medical devices with a same or similar classification in a foreign jurisdiction or any devices intended for implantation in the human body. Should Buyer purchase or use **onsemi** products for any such unintended or unauthorized application, Buyer shall indemnify and hold **onsemi** and its officers, employees, subsidiaries, affiliates, and distributors harmless against all claims, costs, damages, and expenses, and reasonable attorney fees arising out of, directly or indirectly, any claim of personal injury or death associated with such unintended or unauthorized use, even if such claim alleges that **onsemi** was negligent regarding the design or manufacture of the part. **onsemi** is an Equal Opportunity/Affirmative Action Employer. This literature is subject to all applicable copyright laws and is not for resale in any manner.

PUBLICATION ORDERING INFORMATION

LITERATURE FULFILLMENT:

Email Requests to: orderlit@onsemi.com

onsemi Website: www.onsemi.com

TECHNICAL SUPPORT

North American Technical Support:
Voice Mail: 1 800-282-9855 Toll Free USA/Canada
Phone: 011 421 33 790 2910

Europe, Middle East and Africa Technical Support:

Phone: 00421 33 790 2910

For additional information, please contact your local Sales Representative