

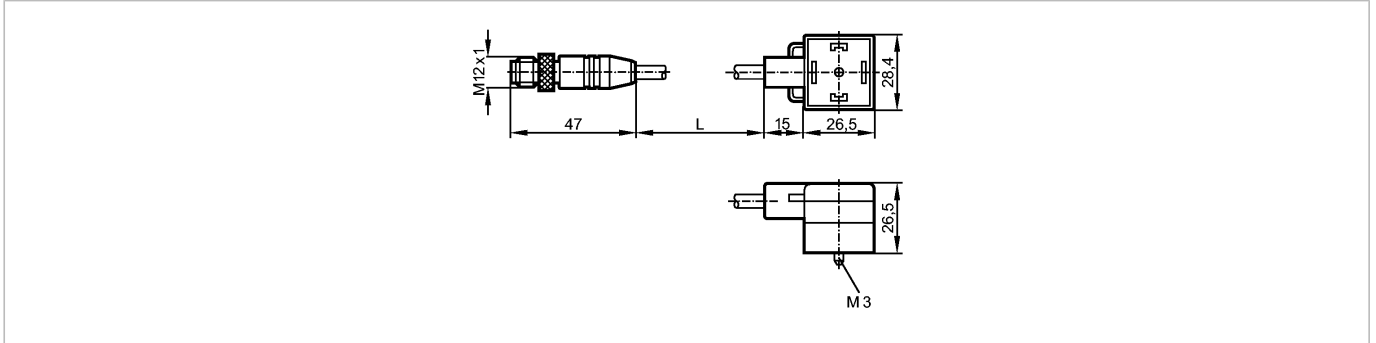

VVDAA040MSS0002H03STGH020MSS

Connection technology



Product characteristics

Jumper

M12 plug / valve plug type A (according to DIN EN 175301-803)

for current measurement

Electrical data

Electrical design

AC/DC

Operating voltage [V]

24 AC/DC

Environment

Ambient temperature [°C]

-40...90

Protection

IP 67 / IP 69K

Mechanical data

Design

straight / angled

Material body

TPU

Material nut

Brass; nickel-plated

Tightening torque for knurled nut [Nm]

0.5

Weight [kg]

0.153

Electrical connection

Connection

PUR cable / 2 m; 2 x 0.75 mm²

Wiring

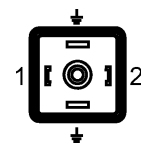
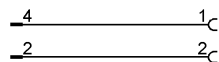

Accessories

Accessories (included)

screw; tag for labelling

Remarks

Pack quantity

[piece]

1