

TL3301 SERIES TACT SWITCH

ANTI-VANDAL SWITCHES
DETECTOR SWITCHES
DIP SWITCHES
KEYLOCK SWITCHES
NAVIGATION SWITCHES
PUSHBUTTON SWITCHES
ROCKER SWITCHES
ROTARY SWITCHES
SLIDE SWITCHES
SNAP ACTION SWITCHES
TACTILE SWITCHES
TOGGLE SWITCHES
CAP OPTIONS

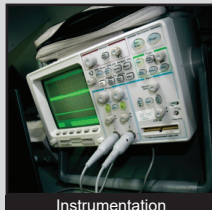

APPLICATIONS / MARKETS

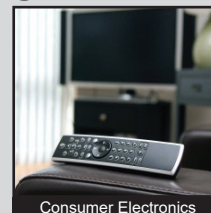
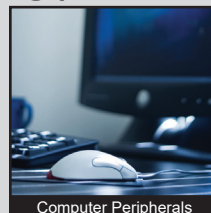
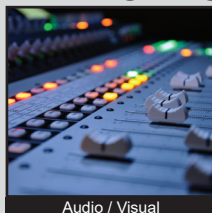

RoHS

SPECIFICATIONS

Contact Rating: 50mA @ 12VDC
Electrical Life: 100,000 gf
Contact Resistance: 100mΩ Max
Insulation Resistance: 100MΩ Min @ 500VDC
Dielectric Strength: 250VAC for 1 Minute
Operating Temperature: -40°C to 85°C
Storage Temperature: -40°C to 85°C
Travel: 0.25mm
Contact Arrangement: SPST
Actuation Force: 100gf; 160gf; 260gf

FEATURES & BENEFITS

- Single pole single throw
- Surface mount
- 6mm x 6mm
- Cap options
- Multiple actuator options

PART NUMBER CONFIGURATOR

Series

TL3301

Actuator Options

A - 5.0mm (no cap)
 B - 9.5mm (no cap)
 C - 8.0mm (no cap)
 D - 13.0mm (no cap)
 E - 7.3mm (no cap)
 F - 7.0mm (no cap)
 N - 4.3mm (no cap)
 P - 8.5mm (no cap)
 SP - 2.8mm square cap
 T - 2.4mm square cap

Actuation Force

F100 - 100 gf
 F160 - 160 gf
 F260 - 260 gf

Contact Material

Q - Silver
 R - Gold

Termination

G - Gullwing
 J - J-lead

Cap Options

Order Caps Separately

Specifications subject to change without notice 1.19.2021



E-SWITCH®

www.e-switch.com

800.867.2717

1

TL3301 SERIES TACT SWITCH

TERMINATION OPTIONS

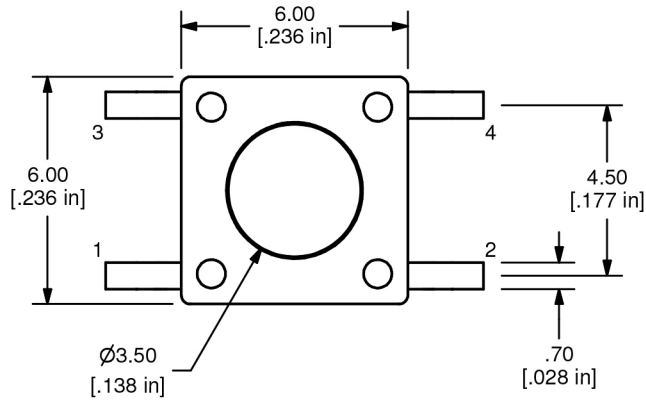

ACTUATOR OPTION	"L" DIMENSION
N	4.3mm
A	5.0mm
E	7.3mm
F	7.0mm
C	8.0mm
P	8.5mm
B	9.5mm
D	13.0mm

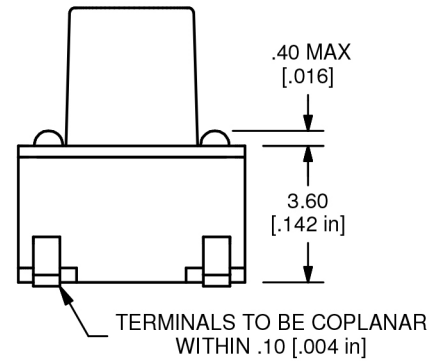
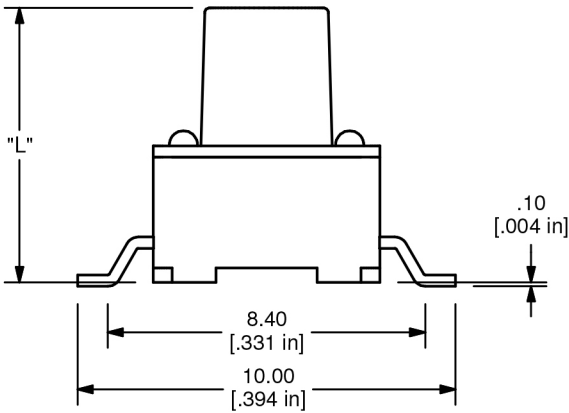

GULLWING TERMINATION

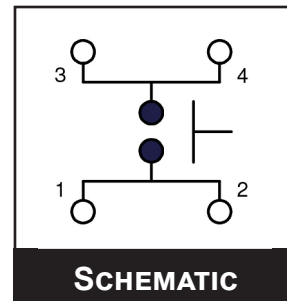
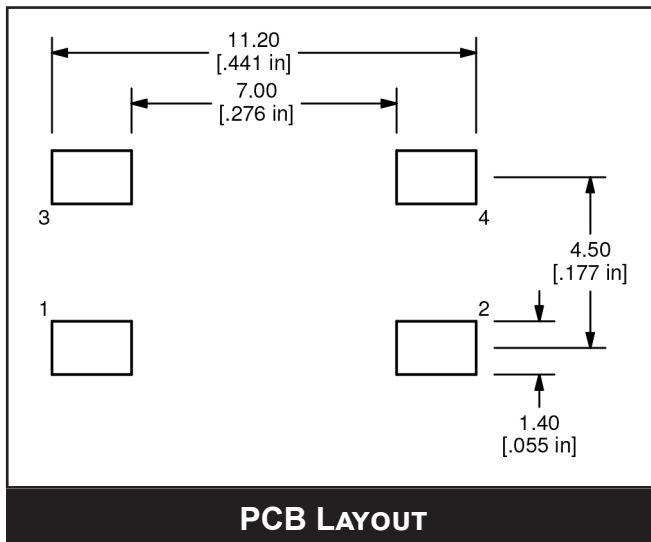

ANTI-VANDAL SWITCHES
 DETECTOR SWITCHES
 DIP SWITCHES
 KEYLOCK SWITCHES
 NAVIGATION SWITCHES
 PUSHBUTTON SWITCHES
 ROCKER SWITCHES
 ROTARY SWITCHES
 SLIDE SWITCHES
 SNAP ACTION SWITCHES
 TACTILE SWITCHES
 TOGGLE SWITCHES
 CAP OPTIONS

TL3301 SERIES TACT SWITCH

TERMINATION OPTIONS

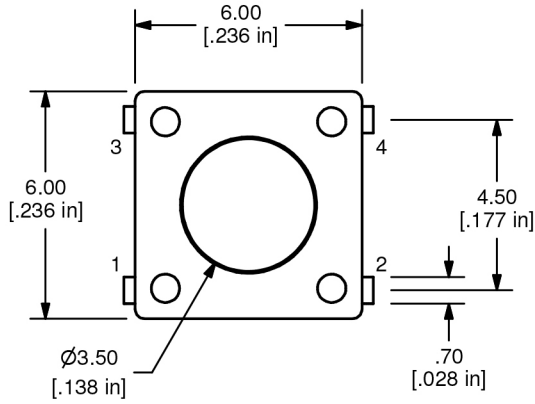

ACTUATOR OPTION	"L" DIMENSION
N	4.3mm
A	5.0mm
E	7.3mm
F	7.0mm
C	8.0mm
P	8.5mm
B	9.5mm
D	13.0mm

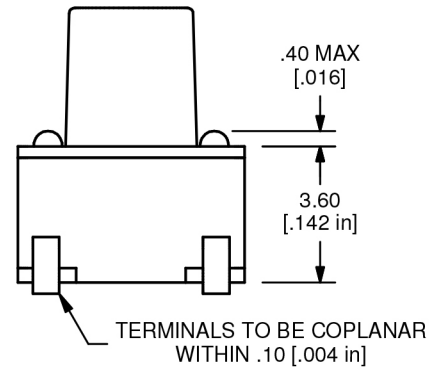
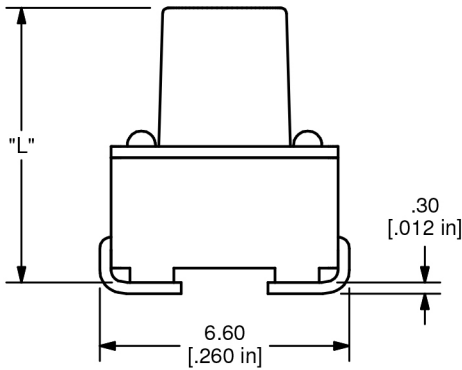

J-LEAD TERMINATION

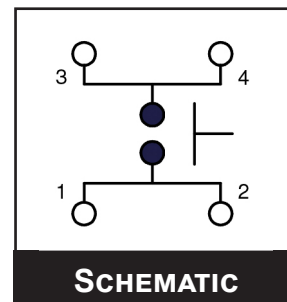
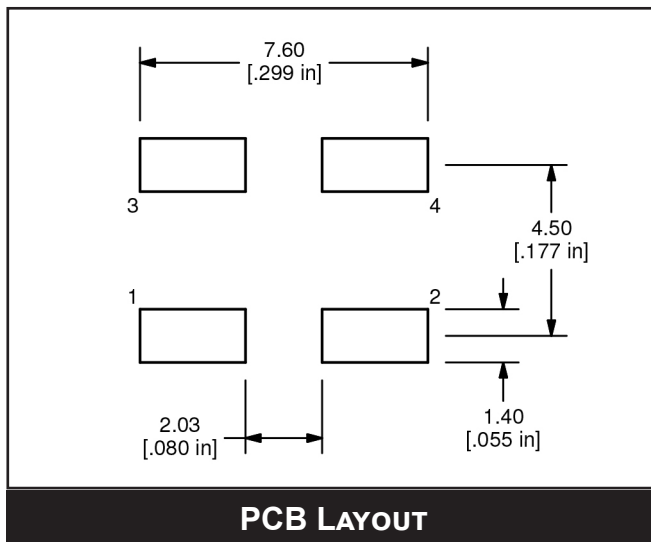

TL3301 SERIES TACT SWITCH

ACTUATOR OPTIONS

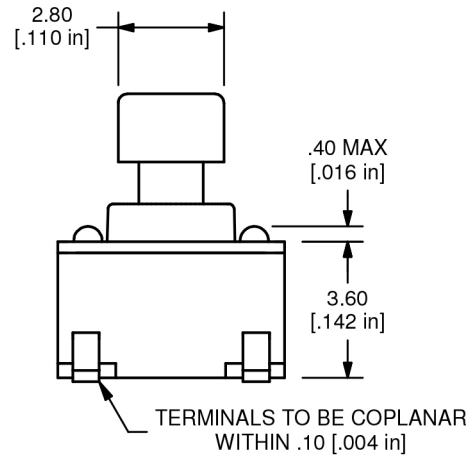
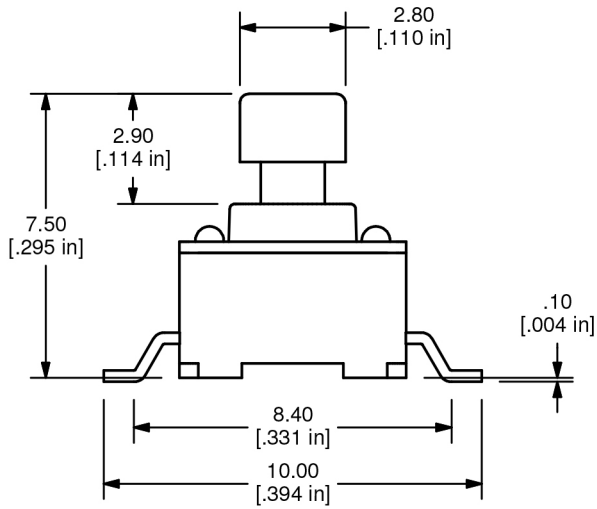
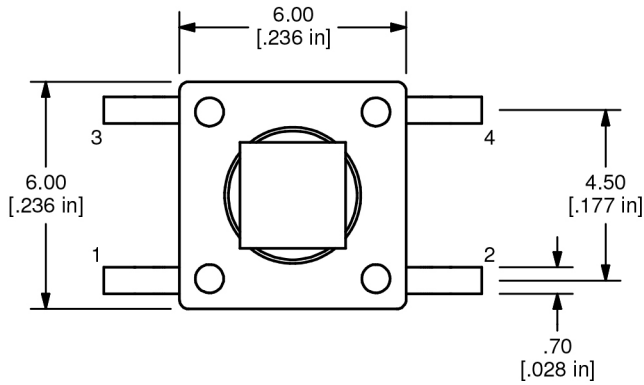

SP ACTUATOR
(GULLWING TERMINATION SHOWN)

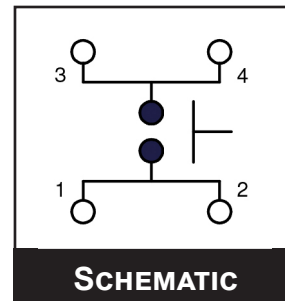
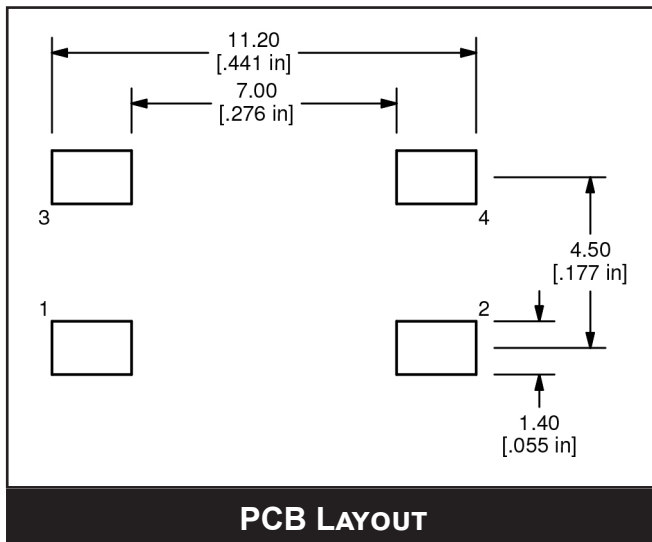

- ANTI-VANDAL SWITCHES
- DETECTOR SWITCHES
- DIP SWITCHES
- KEYLOCK SWITCHES
- NAVIGATION SWITCHES
- PUSHBUTTON SWITCHES
- ROCKER SWITCHES
- ROTARY SWITCHES
- SLIDE SWITCHES
- SNAP ACTION SWITCHES
- TACTILE SWITCHES**
- TOGGLE SWITCHES
- CAP OPTIONS

TL3301 SERIES TACT SWITCH

TERMINATION OPTIONS

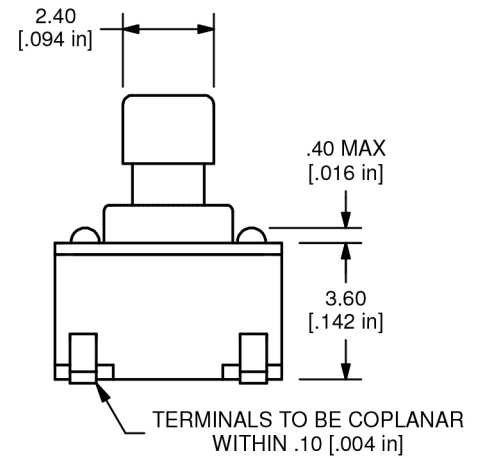
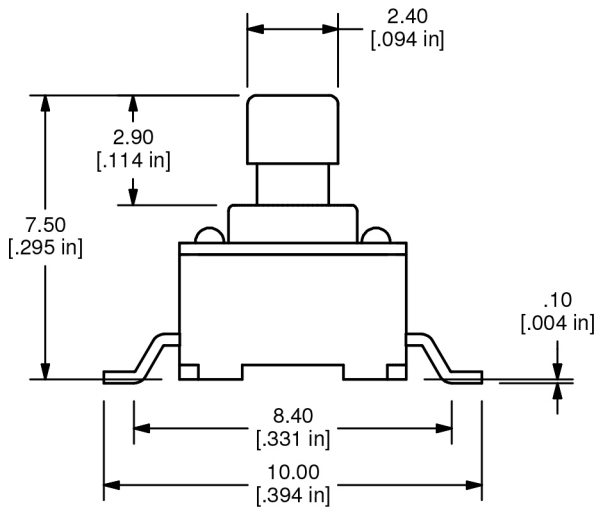
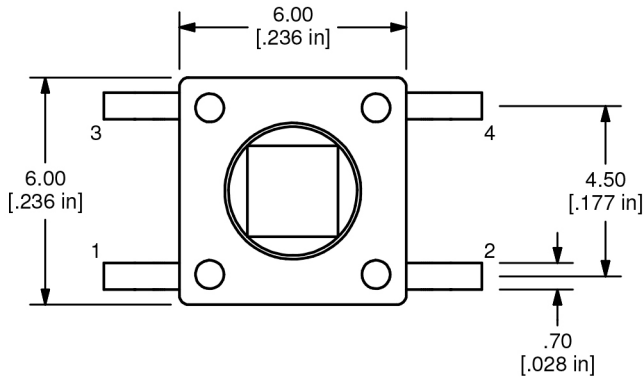

T ACTUATOR (GULLWING TERMINATION SHOWN)

