

## MET 1-PHASE CONTROL AND ISOLATION TRANSFORMER

P: 630VA IN: 230VAC+/- 5% OUT: 230VAC

Single-phase - Control and Isolation Transformers  
 630 VA  
 Spring clamp terminals  
 Isolation class T 60/B

### [Link to Product](#)

#### Illustration

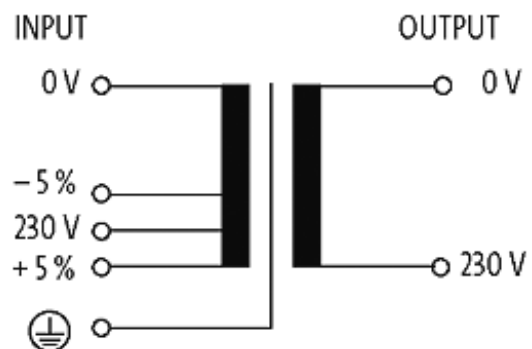

stay connected

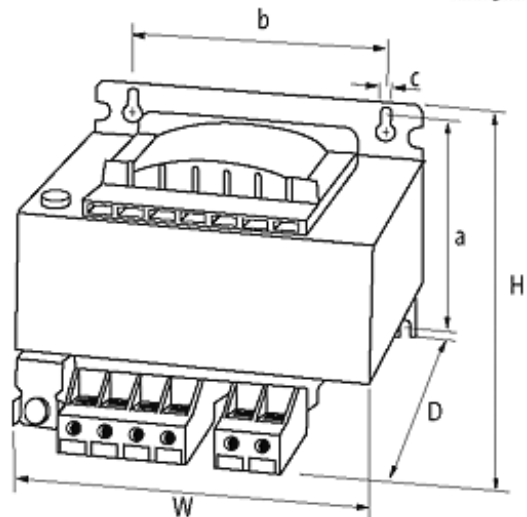

Product may differ from Image

### Approvals



### Input

Input voltage	230 V AC $\pm 5\%$
Frequency	50...60 Hz
Input current	2.98 A (230 V AC)
Short-circuit current	82.3 A (230 V AC)
Inrush current	75.6 A (230 V AC)

### General data

Standards	(EN 61558-1), (EN 61558-2-4), (EN 62041 category 0)
Test isolation voltage	4 kV (prim./sec.)
Dimensions H x W x D	129x150x148 mm
Fixing centers a x b x c	107.5x122x7 mm
Drill hole $\varnothing$	7x11 mm
Mounting method	Key-hole mounting
Temperature range	-20...+60 °C, no condensation

### Output

Output voltage	230 V AC
----------------	----------

### Commercial data

country of origin	CZ
customs tariff number	85043180
minimum order quantity	1