

M12 MALE 0° / MSUD VALVE PLUG FORM BI 11MM

PUR 3X0.75 YELLOW, ROBOT, drag ch 1m

Form BI (11 mm) – M12, male straight
LED and suppression
3-pole

Further cable lengths on request. Plastic housings with good resistance against chemicals and oils. The resistance to aggressive media should be individually tested for your application. Further details on request.

[Link to Product](#)

Illustration

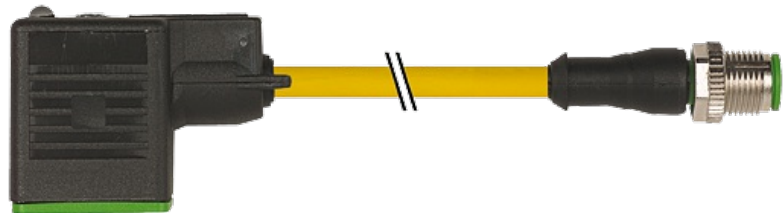

Female

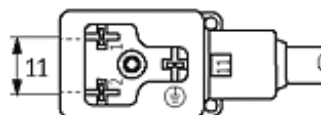

Male



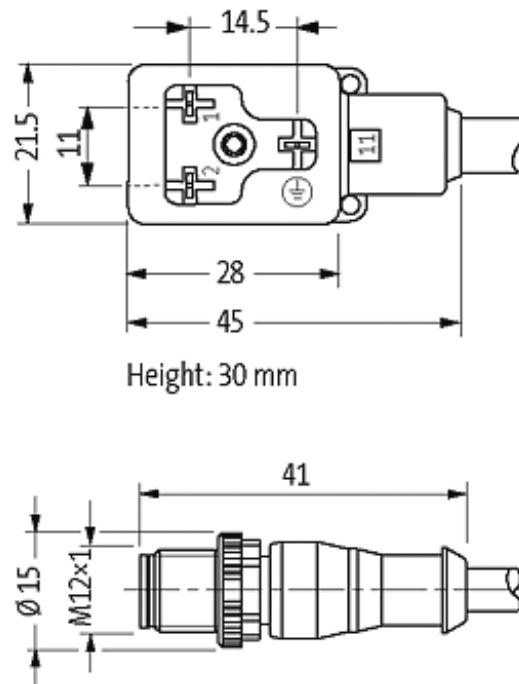

Product may differ from Image

Approvals



Form

40961

Technical Data

Operating voltage	24 V AC $\pm 20\%$ / DC $\pm 25\%$
Operating current per contact	max. 4 A
Switch off peak	max. 55 V
Switch off delay time	max. 20 ms
Locking of ports	M3/M12 \times 1 mm (recommended torque 0.4/0.6 Nm)
Protection	IP67 inserted and tightened (EN 60529)
Housing	Black plastic (gray on request)

Cables

Cable number	056
No./diameter of wires	3 \times 0.75 mm ²
Wire isolation	PP (bk, num, gnye)
C-track properties	10 Mio.
Torsion	1 Mio. \pm 360°/m
Jacket Color	yellow
Shore hardness outer jacket	58 \pm 3D
Material (jacket)	PUR (UL/CSA), welding spark res.

The information in this brochure has been compiled with the utmost care.

Liability for the correctness completeness and topicality of the information is restricted to gross negligence. Version: 05/15

Outer diameter	approx. 5.2 mm
Bend radius (fixed)	5 × outer Ø
Bend radius (moving)	10 × outer Ø
Temperature range (fixed)	-40...+90 °C
Temperature range (mobile)	-25...+90 °C

General data

Temperature range	-25...+85 °C, depending on cable quality
-------------------	--

Commercial data

country of origin	DE
customs tariff number	85444290
minimum order quantity	1