

M12 male 0° / M12 male 0° shielded Y-cod. hybrid

PUR 4xAWG20+1x4xAWG26 shielded bk 3m

Ethernet CAT 5

Male straight to male straight

M12 - M12

8-pole, shielded

Further cable lengths on request. Plastic housings with good resistance against chemicals and oils. The resistance to aggressive media should be individually tested for your application. Further details on request.

[Link to Product](#)

Illustration

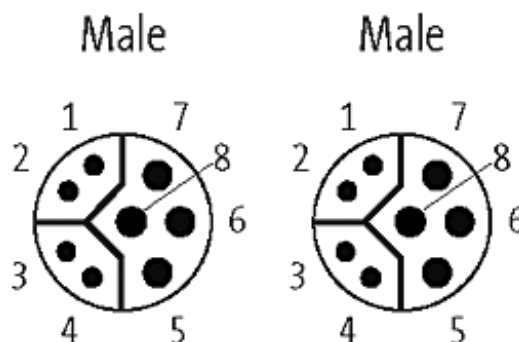
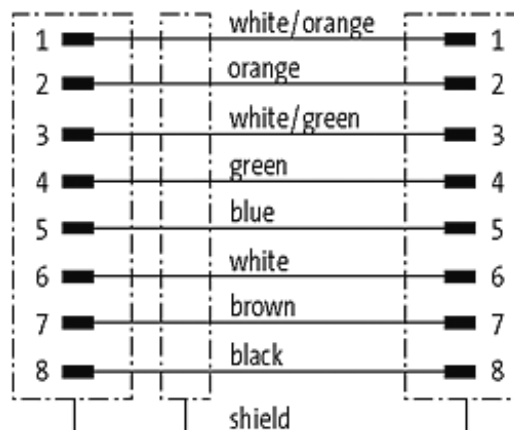

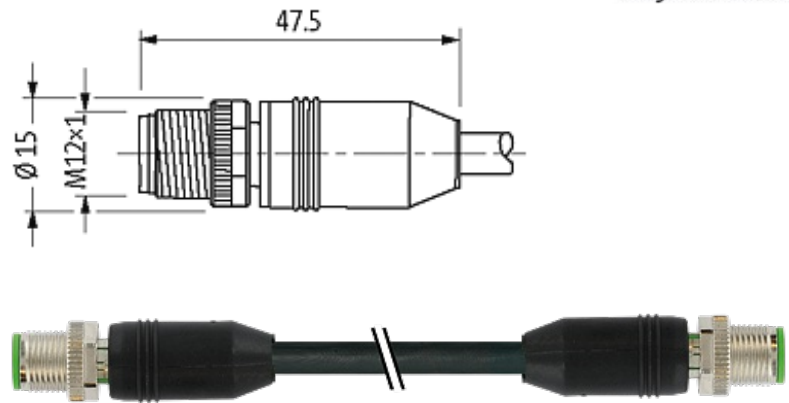

Product may differ from Image

More Info



Form

47001

Technical Data

Operating voltage	30 V DC
Operating current per contact	0.5 A (Data), 6 A (Power)
Locking of ports	Screw thread M12 × 1 mm (recommended torque 0.6 Nm) self-securing
Protection	IP67 inserted and tightened (EN 60529)

Cables

Cable number	805
No./diameter of wires	4×0.6 mm ² + 1×(4×0.15 mm ²)
Wire isolation	PP (whor, or, whgn, gn, bk, br, wh, bl)
C-track properties	5 Mio.
Torsion	2 Mio. ± 30°/m
Jacket Color	black
Shore hardness outer jacket	90 ± 5A
Material (jacket)	PUR (UL/CSA)
Outer diameter	approx. 8.1 mm
Bend radius (fixed)	5 × outer Ø
Bend radius (moving)	10 × outer Ø
Temperature range (fixed)	-50...+80 °C
Temperature range (mobile)	-40...+80 °C
Shielded	yes

General data

Temperature range	-25...+85 °C, depending on cable quality
-------------------	--

Commercial data

country of origin	DE
customs tariff number	85444290
minimum order quantity	1