

# San Ace 120

## 9RA type

### DC Fan

#### Features

##### Low Noise and Energy Saving

Compared to our current model,<sup>(1)</sup> noise level has been more than halved<sup>(2)</sup> and power consumption has been reduced by 39%.<sup>(3)</sup>

Moreover, the models with PWM control, which enables the control of fan speed, provide further optimized noise level and efficiency.

##### Long Life

This fan lasts 1.5 times longer than the current model,<sup>(1)</sup> and is capable of continuous operation for 60,000 hours (approximately 7 years), improving the maintainability.

##### Rich Lineup

The product lineup is available in a wide variety in 12/24/48 voltage, cooling performance, noise level, and PWM control. This allows users to choose the most suitable one for their applications.

(1) Current model: 120 x 120 x 25 mm San Ace 120 9G type DC Fan (model: 9G1212G401).

(2) A 4 dB(A) decrease in noise level.

(3) For models 9RA1212P4G001 and 9RA1212G4001



## 120 x 120 x 25 mm

#### Specifications

The models listed below **have ribs and pulse sensors with PWM control function**. For models without ribs, append "1" to the end of model numbers.

Model no.	Rated voltage [V]	Operating voltage range [V]	PWM duty cycle* [%]	Rated current [A]	Rated input [W]	Rated speed [min <sup>-1</sup> ]	Max. airflow [m <sup>3</sup> /min] [CFM]	Max. static pressure [Pa] [inchH <sub>2</sub> O]	Noise level [dB(A)]	Operating temperature [°C]	Expected life [h]
9RA1212P4G001	12	10.8 to 13.2	100	0.55	6.6	4500	3.68 130	120 0.48	47	-20 to +70	60000/60°C (90000/40°C)
			20	0.06	0.72	1250	1.02 36	9.2 0.037	15		
9RA1224P4G001	24	21.6 to 26.4	100	0.28	6.72	4500	3.68 130	120 0.48	47		
			20	0.05	1.2	1750	1.43 50.5	18.1 0.073	22		
9RA1248P4G001	48	43.2 to 52.8	100	0.15	7.2	4500	3.68 130	120 0.48	47		
			20	0.03	1.44	1650	1.34 47.3	16.1 0.065	21		

\* PWM input frequency is 25 kHz; models without specifications at 0% PWM duty cycle have zero fan speed at 0%.

The models listed below **have ribs and pulse sensors**. For models without ribs, append "1" to the end of model numbers.

Model no.	Rated voltage [V]	Operating voltage range [V]	Rated current [A]	Rated input [W]	Rated speed [min <sup>-1</sup> ]	Max. airflow [m <sup>3</sup> /min] [CFM]	Max. static pressure [Pa] [inchH <sub>2</sub> O]	Noise level [dB(A)]	Operating temperature [°C]	Expected life [h]
9RA1212G4001	12	7 to 13.8	0.55	6.6	4500	3.68 130	120 0.48	47	-20 to +70	60000/60°C (90000/40°C)
9RA1212E4001			0.41	4.92	4000	3.3 116.5	96 0.386	45		
9RA1212A4001			0.3	3.6	3500	2.86 101.1	73 0.293	42		
9RA1212H4001			0.26	3.12	3200	2.62 92.4	61 0.245	39		
9RA1212M4001			0.12	1.44	2200	1.8 63.5	29 0.116	28		
9RA1224G4001	24	14 to 27.6	0.28	6.72	4500	3.68 130	120 0.48	47		
9RA1224E4001			0.22	5.28	4000	3.3 116.5	96 0.386	45		
9RA1224A4001			0.16	3.84	3500	2.86 101.1	73 0.293	42		
9RA1224H4001			0.13	3.12	3200	2.62 92.4	61 0.245	39		
9RA1224M4001			0.07	1.68	2200	1.8 63.5	29 0.116	28		
9RA1248G4001	48	36 to 55.2	0.15	7.2	4500	3.68 130	120 0.48	47		
9RA1248E4001			0.11	5.28	4000	3.3 116.5	96 0.386	45		
9RA1248A4001			0.09	4.32	3500	2.86 101.1	73 0.293	42		

Models with the following sensor specifications are also available as options: **Without sensor** **Lock sensor**

#### Common Specifications

- Material ..... Frame: Plastic (Flammability: UL 94V-0), Impeller: Plastic (Flammability: UL 94V-1)
- Expected life ..... Refer to specifications  
(L10 life: 90% survival rate for continuous operation in free air at 60°C, rated voltage)  
Expected life at 40°C is for reference only.
- Motor protection function ..... Locked rotor burnout protection, Reverse polarity protection
- Dielectric strength ..... 50/60 Hz, 500 VAC, for 1 minute (between lead wire conductors and frame)
- Insulation resistance ..... 10 MΩ or more with a 500 VDC megger (between lead wire conductors and frame)
- Noise level ..... At 1 m away from the air inlet
- Operating temperature ..... Refer to specifications (Non-condensing)
- Storage temperature ..... -30 to +70°C (Non-condensing)
- Lead wire ..... ⊕ Red ⊖ Black (Sensor) Yellow (Control) Brown
- Mass ..... 210 g

## Airflow - Static Pressure Characteristics

PWM duty cycle

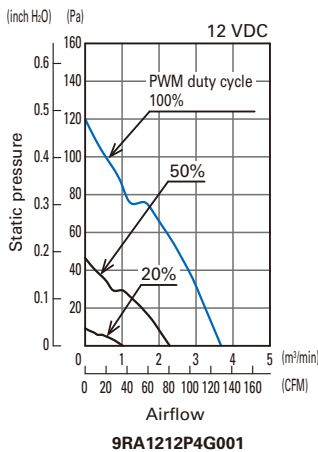

9RA1212P4G001

Operating voltage range

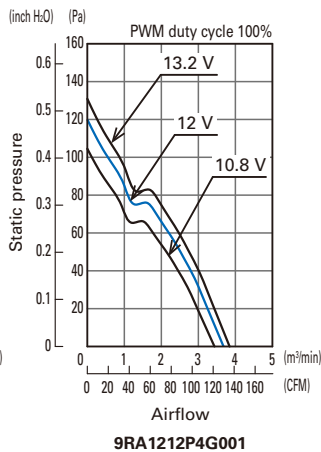

9RA1212P4G001

PWM duty cycle

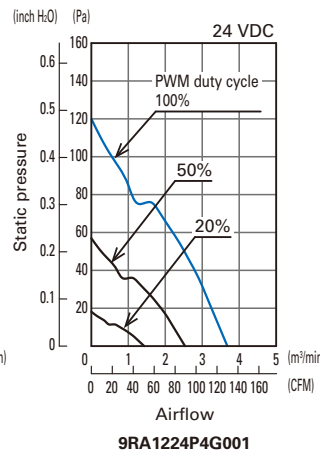

9RA1224P4G001

Operating voltage range

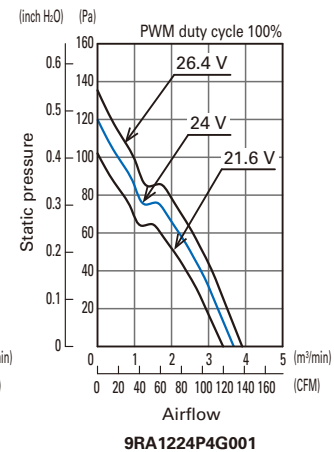

9RA1224P4G001

PWM duty cycle

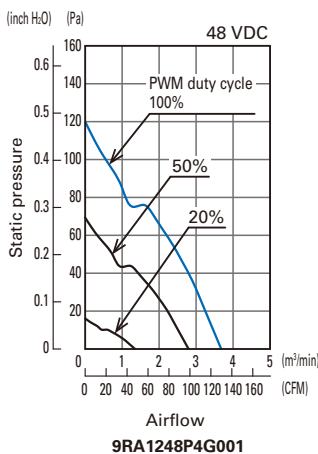

9RA1248P4G001

Operating voltage range

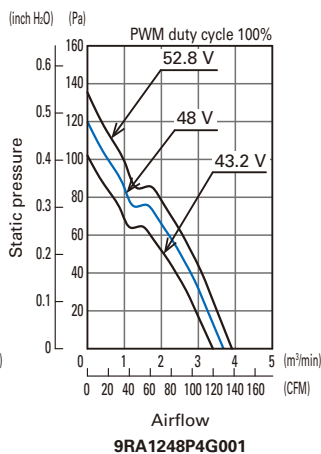

9RA1248P4G001

PWM duty cycle

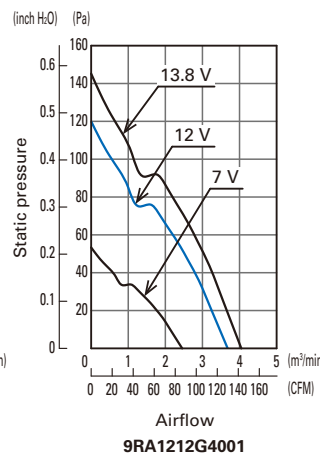

9RA1212G4001

Operating voltage range

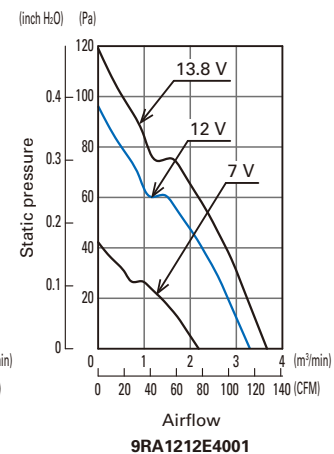

9RA1212E4001

Operating voltage range

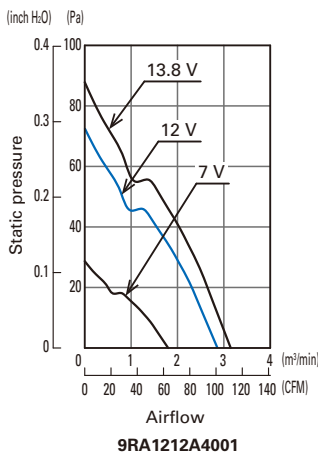

9RA1212A4001

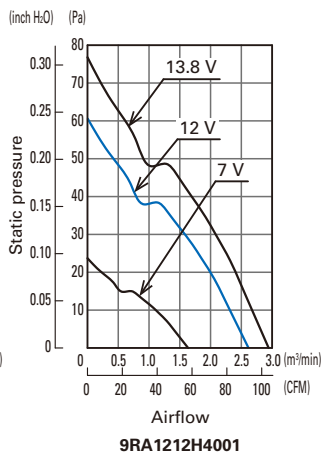

9RA1212H4001

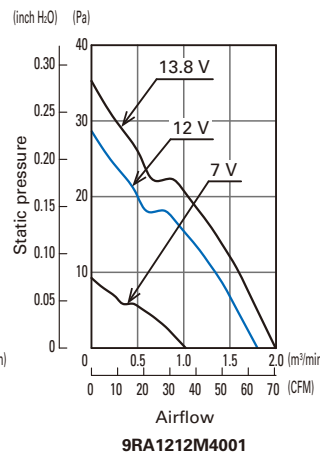

9RA1212M4001

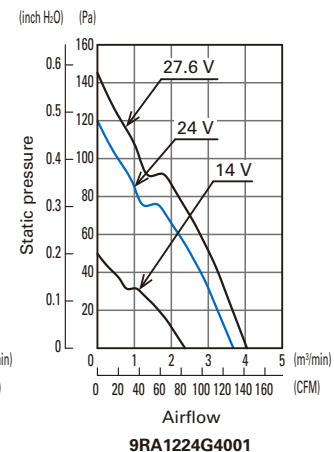

9RA1224G4001

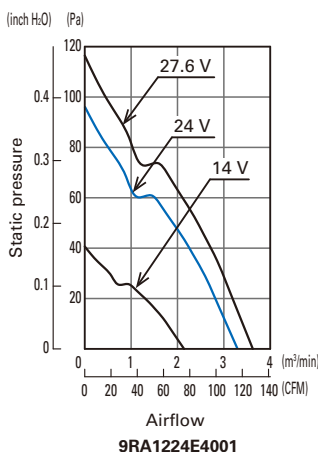

9RA1224E4001

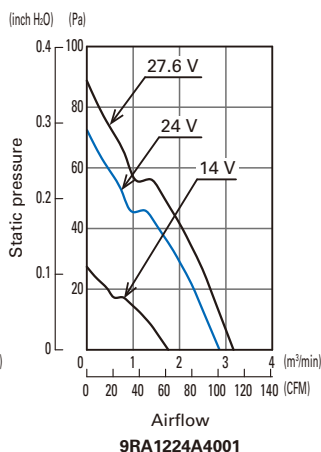

9RA1224A4001

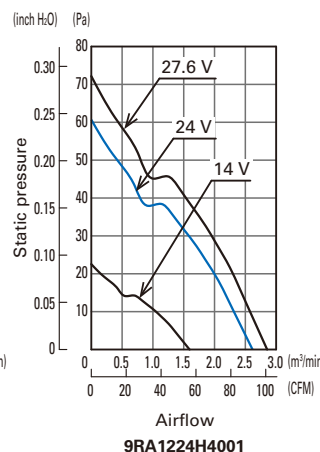

9RA1224H4001

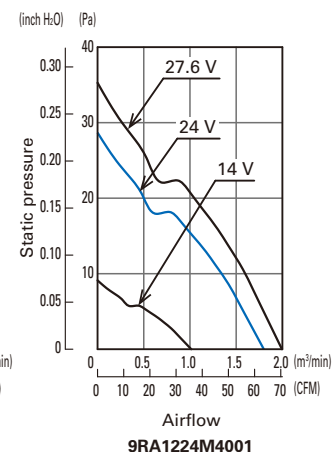

9RA1224M4001

## Airflow - Static Pressure Characteristics

Operating voltage range

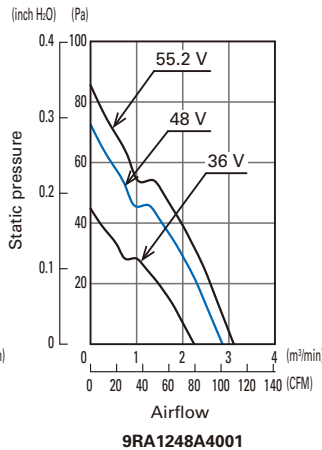
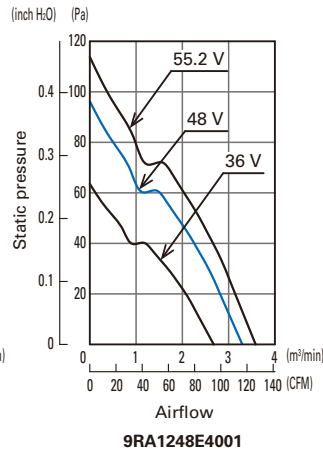
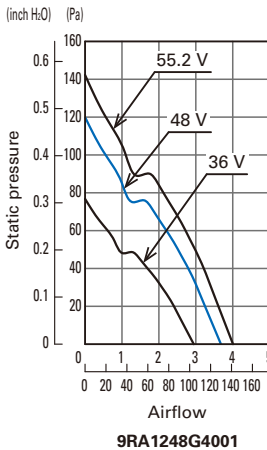

## PWM Duty - Speed Characteristics Example

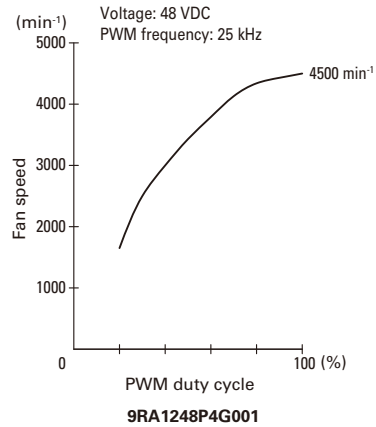
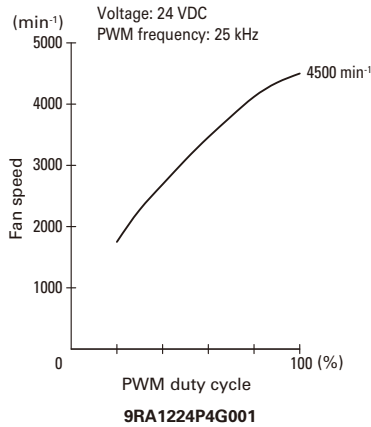
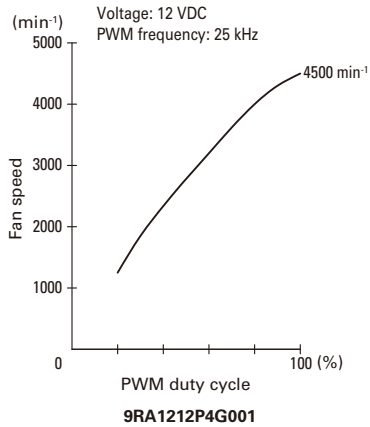

## PWM Input Signal Example

Input signal waveform

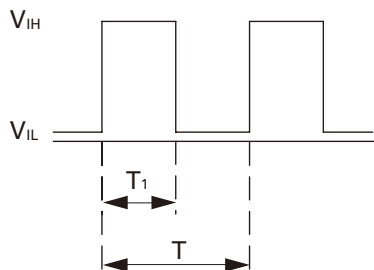

$$V_{IH} = 4.75 \text{ to } 5.25 \text{ V} \quad V_{IL} = 0 \text{ to } 0.4 \text{ V}$$

$$\text{PWM duty cycle (\%)} = \frac{T_1}{T} \times 100 \quad \text{PWM frequency } 25 \text{ (kHz)} = \frac{1}{T}$$

Current source ( $I_{source}$ ) = 1.0 mA max. (when control voltage is 0 V)

Current sink ( $I_{sink}$ ) = 1.0 mA max. (when control voltage is 5.25 V)

When the PWM control terminal is open,

the fan speed is the same as the speed at 100% PWM duty cycle.

Either a TTL input or open collector/drain input can be used for the PWM input signal.

## Example of Connection Schematic

Rated voltage 12/24 V fan

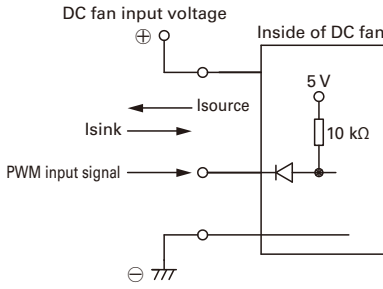

Rated voltage 48 V fan

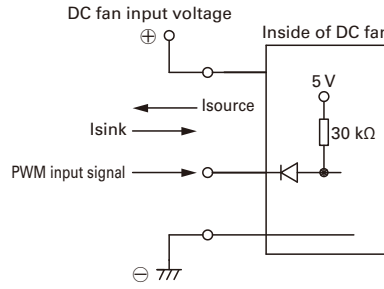

## Specifications for Pulse Sensors

Output circuit: Open collector

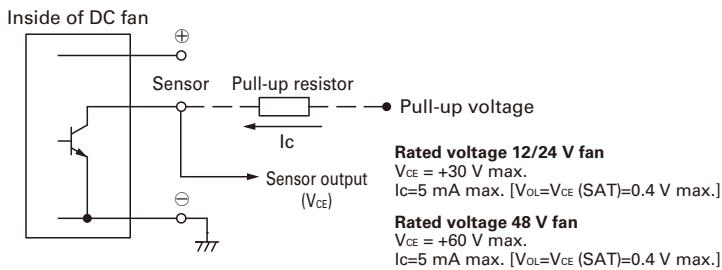

Output waveform (Need pull-up resistor)

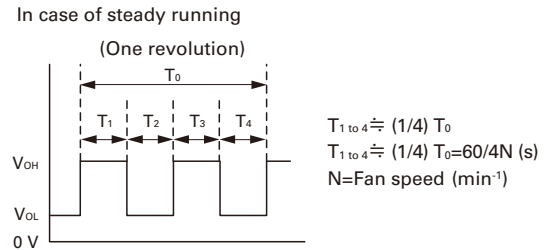

## Dimensions (unit: mm) (With pulse sensor with PWM control function)

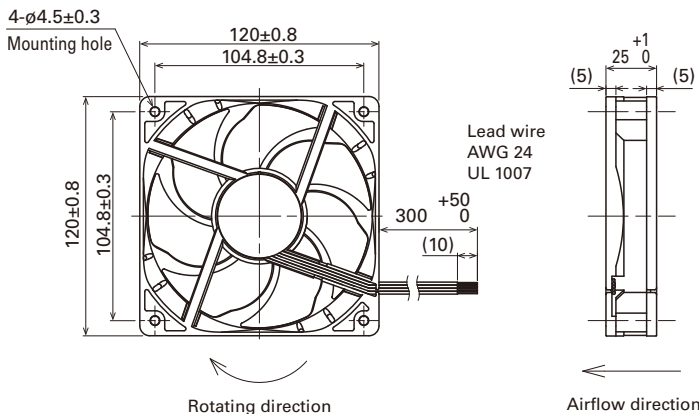

## Reference Dimensions of Mounting Holes and Vent Opening (unit: mm)

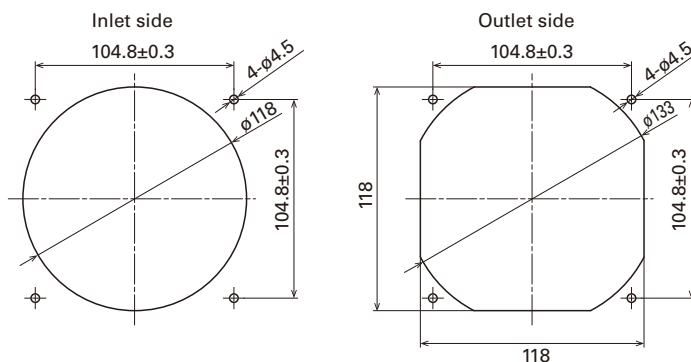

## Notice

- Please read the "Safety Precautions" on our website before using the product.
- The products shown in this catalog are subject to Japanese Export Control Law. Diversion contrary to the law of exporting country is prohibited.
- For protecting fan bearings against electrolytic corrosion near strong electromagnetic noise sources, we provide effective countermeasures such as Electrolytic Corrosion Proof Fans and EMC guards. Contact us for details.

**SANYO DENKI CO., LTD.** 3-33-1 Minami-Otsuka, Toshima-ku, Tokyo 170-8451, Japan TEL: +81 3 5927 1020

<https://www.sanyodenki.com/>

The names of companies and/or their products specified in this catalog are the trade names, and/or trademarks and/or registered trademarks of such respective companies.

"San Ace" is a trademark of SANYO DENKI CO., LTD.  
 Specifications are subject to change without notice.

CATALOG No. C1123B003 '21.10