

EVW182

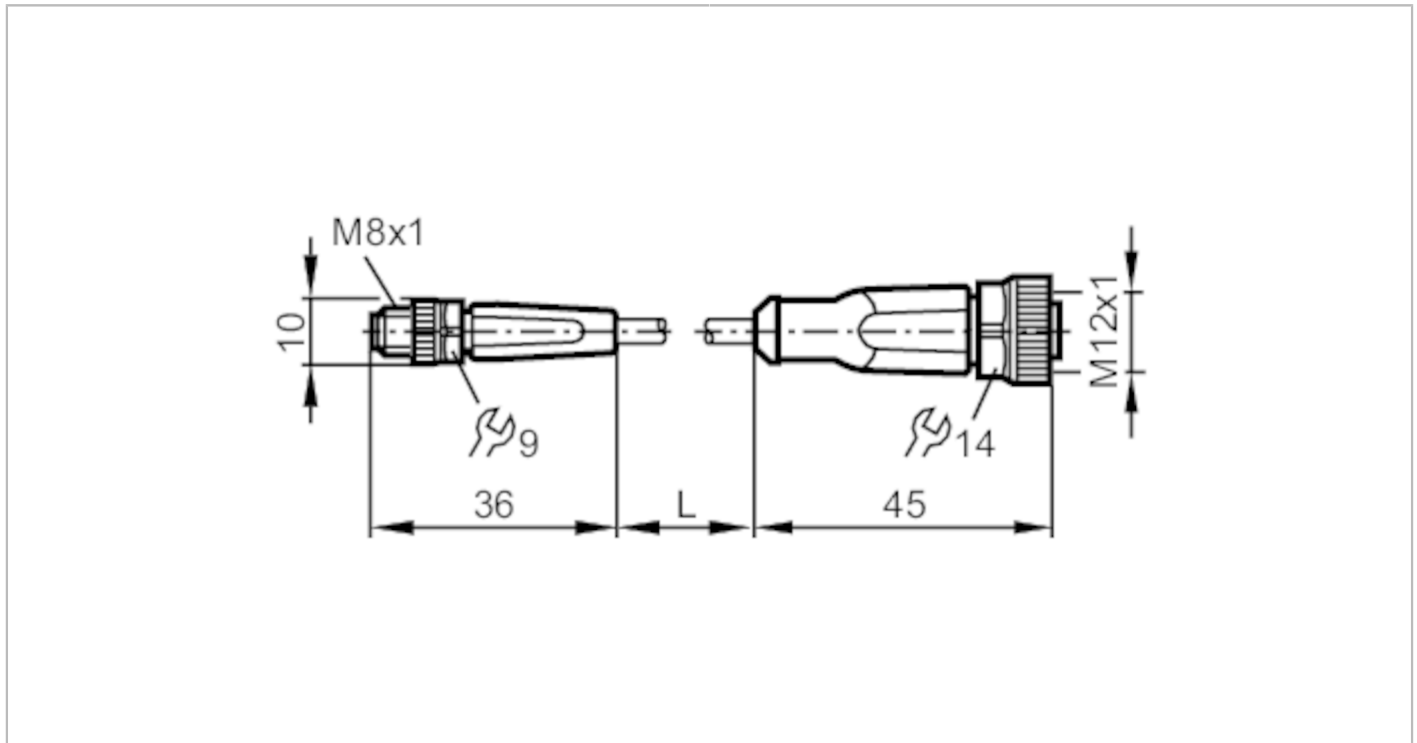

Connection cable

VDOGH030SCS00,6T03STGF030SCS



Application		
Special feature	Free from silicone; Halogen-free; Gold-plated contacts; Drag chain suitability	
Application	welding applications	
Free from silicone	yes	
Electrical data		
Operating voltage [V]	< 50 AC / < 60 DC	
Protection class	III	
Max. current load total [A]	3	
Operating conditions		
Ambient temperature [°C]	-25...90	
Ambient temperature (moving) [°C]	-25...90	
Protection	IP 65; IP 67; IP 68; IP 69K	
Mechanical data		
Weight [g]	42.7	
Materials	housing: TPU orange; Sealing: FKM	
Material nut	brass, anti-spatter / brass, anti-spatter	
Drag chain suitability	yes	
Drag chain suitability	bending radius for flexible use	min. 10 x cable diameter
	travel speed	max. 3.3 m/s for a horizontal travel length of 5 m and max. acceleration of 5 m/s ²
	bending cycles	> 2 Mio.
	torsional strain	± 180 °/m
Remarks		
Remarks	without label holders	
Pack quantity	1 pcs.	

EVW182



Connection cable

VDOGH030SCS00,6T03STGF030SCS

Electrical connection - plug

Connector: 1 x M8, straight; Locking: brass, anti-spatter; Contacts: gold-plated; Tightening torque: 0.3...0.5 Nm



Electrical connection

Cable: 0.6 m, PUR, Halogen-free, grey, Ø 4.5 mm; not irradiated (can be recycled); resistant to welding sparks; 3 x 0.25 mm² (32 x Ø 0.1 mm)

Connection

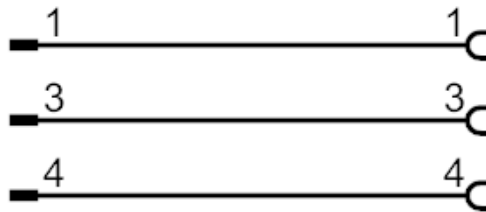

Electrical connection - socket

Connector: 1 x M12, straight; Locking: brass, anti-spatter; Contacts: gold-plated; Tightening torque: 0.6...1.5 Nm

