



NEUTRIK PROFESSIONAL XLR-TYPE AUDIO CONNECTORS

These remarkable *Swiss-made* audio connectors are manufactured to exacting standards. They feature a number of unique innovations, such as a chuck-type cable clamp and no loose parts for single, time-saving assembly. Helicon phosphor bronze contacts for easier mating and better, longer-lived contact integrity. Vented solder cups for improved solderability. Fiberglass-reinforced fracture proof inserts. Compliant ribs on female insert to prevent mic-to-connector rattle. Make-first/break-last feature of pin 1 to ensure equipment-protecting shield connection. Ground contacts to maintain ground continuity between mating shells. Superior spring-steel latching mechanism. Right-angle connectors with 45° indexing. Stock connectors have silver-plated or gold-plated contacts and high-density, scratchproof satin nickel, stainless steel or black chrome finish.



NC3MX

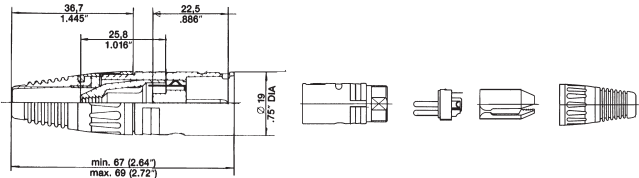

NEUTRIK MX SERIES MALE CABLE CONNECTORS

MX Series: 3 pin male cable connector, rear mountable insert, no tool required.
MX-HD Series: Heavy-duty all metal, stainless steel shell (18/8), dust and water proof according to IP65.

Cat. No.	Contacts	Net Price Each	
		1-49	50-Up
SATIN-NICKEL FINISH, SILVER CONTACTS, ONE PIECE PLASTIC BOOT			
NC3MX-1	3	\$4.23	\$2.12
SATIN-NICKEL FINISH, SILVER CONTACTS			
NC3MX	3	4.58	2.29
NC4MX	4	7.56	3.78
NC5MX	5	10.69	5.35
NC6MX	6	11.88	5.94
NC7MX	7	13.07	6.53
BLACK CHROME FINISH, GOLD CONTACTS			
NC3MX-B	3	6.52	3.26
NC4MX-B	4	9.07	4.54
NC5MX-B	5	13.31	6.65
NC6MX-B	6	15.44	7.72
NC7MX-B	7	19.57	9.78
BLACK CHROME FINISH, SILVER CONTACTS			
NC3MX-BAG	3	6.11	3.06
STAINLESS STEEL FINISH, GOLD CONTACTS			
NC3MX-HD	3	17.65	8.82

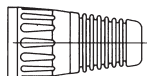

NEUTRIK COLOUR CODED BOOTS

Fits all "X" series connectors.

Cat. No.	Colour	Net Price Each	
		1-49	50-Up
BSX-1	Brown	\$1.21	\$0.60
BSX-2	Red	1.21	.60
BSX-4	Yellow	1.21	.60
BSX-5	Green	1.21	.60
BSX-7	Purple	1.21	.60
BSX-8	Gray	1.21	.60



NC3FX



NC3FX-S



NC3FX-HD

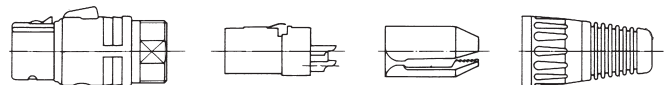
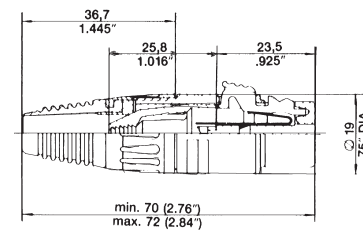

NEUTRIK FX SERIES FEMALE CABLE CONNECTORS

FX Series: 3-pole female cable connector, one piece unbreakable die-cast housing, damping ring for tight and noiseless fit, steel latch lock with ground contacts. **FX-HD Series:** Heavy-duty metal strain relief bushing, rubber jacket, dust and water protected according to IP65 when mated with MX-HD, minimum IP54 with most other mating connectors or microphones. **FX-S Series:** All metal cable connector with integrated ON-OFF rotary switch (OFF: short circuit between contacts 2 and 3). Noiseless, easy to operate and to assemble.

Cat. No.	Socket Contacts	Net Price Each	
		1-49	50-Up
SATIN-NICKEL FINISH, SILVER CONTACTS, ONE PIECE PLASTIC BOOT			
NC3FX-1	3	\$4.73	\$2.37
SATIN-NICKEL FINISH, SILVER CONTACTS			
NC3FX	3	5.10	2.55
NC4FX	4	9.74	4.87
NC5FX	5	13.61	6.80
NC6FX	6	14.95	7.47
NC7FX	7	18.81	9.41
BLACK CHROME FINISH, GOLD CONTACTS			
NC3FX-B	3	7.43	3.72
NC4FX-B	4	12.01	6.00
NC5FX-B	5	16.70	8.35
NC6FX-B	6	21.36	10.68
NC7FX-B	7	24.95	12.47
BLACK CHROME FINISH, SILVER CONTACTS			
NC3FX-BAG	3	6.74	3.37
STAINLESS STEEL FINISH, SILVER CONTACTS			
NC3FX-HD	3	17.65	8.82
SATIN-NICKEL FINISH, SILVER CONTACTS			
NC3FX-S	3	20.26	10.13

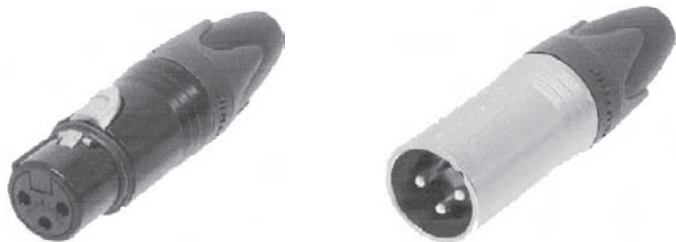

NEUTRIK MXX SERIES MALE AND FEMALE CONNECTORS

The new improved chuck type strain relief with higher pull out force. Improved ratchet lock to prevent accidental opening of the strain relief during handling the cable assembly even in harsh environment. Unique cage type female contact with 7 independent contact springs for a low contact resistance and high integrity. New latch lock design easier to handle.

Cat. No.	Contacts	Net Price
MALE, NICKEL SHELL, SILVER CONTACTS		
MC3MXX	3	\$2.90
MALE, BLACK SHELL, GOLD CONTACTS		
MC3MXX-B	3	4.14
MALE, BLACK SHELL, SILVER CONTACTS		
MC3MXX-BAG	3	3.88
FEMALE, NICKEL SHELL, SILVER CONTACTS		
NC3FXX	3	3.24
FEMALE, BLACK SHELL, GOLD CONTACTS		
NC3FXX-B	3	4.70
FEMALE, BLACK SHELL, SILVER CONTACTS		
NC3FXX-BAG	3	4.26

NEUTRIK COLOUR CODED BOOTS

Fit all "XX" series connectors.

Cat. No.	Colour	Net Price Each	
		1-49	50-Up
BXX-0	Black	\$.83	\$.73
BXX-1	Brown	.83	.73
BXX-2	Red	.83	.73
BXX-3	Orange	.83	.73
BXX-4	Yellow	.83	.73
BXX-5	Green	.83	.73
BXX-6	Blue	.83	.73
BXX-7	Purple	.83	.73
BXX-8	Grey	.83	.73
BXX-9	White	.83	.73

NEUTRIK COLOUR CODED RINGS

Fit all "XX" series connectors.

Cat. No.	Colour	Net Price Each	
		1-49	50-Up
XXR-0	Black	\$.22	\$.18
XXR-1	Brown	.22	.18
XXR-2	Red	.22	.18
XXR-3	Orange	.22	.18
XXR-4	Yellow	.22	.18
XXR-5	Green	.22	.18
XXR-6	Blue	.22	.18
XXR-7	Purple	.22	.18
XXR-8	Grey	.22	.18
XXR-9	White	.22	.18

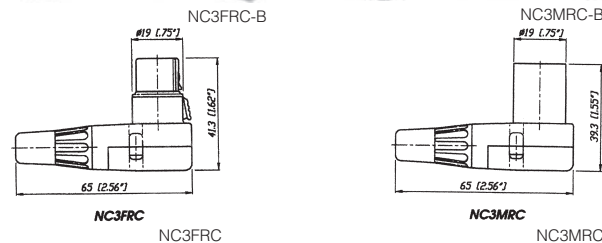

NEUTRIK RIGHT-ANGLE CORD PLUGS

Compact very low profile right-angle connectors. 7 x 45° indexing of main body allows highest packing density. Neutrik Chuck Type cable clamp for cables from 3.8 to 7.5mm dia.

RIGHT-ANGLE FEMALE CORD PLUGS

Cat. No.	Socket Contacts	Net Price Each	
		1-49	50-Up
SATIN-NICKEL FINISH, SILVER CONTACTS			
NC3FRC	3	\$14.08	\$7.04
NC4FRC	4	17.04	8.52
NC5FRC	5	23.05	11.52
NC6FRC	6	26.40	13.20
NC7FRC	7	30.33	20.22
BLACK CHROME FINISH, GOLD CONTACTS			
NC3FRC-B	3	18.47	9.23
BLACK CHROME FINISH, SILVER CONTACTS			
NC3FRC-BAG	3	14.99	7.50

RIGHT-ANGLE MALE CORD PLUGS

Cat. No.	Pin Contacts	Net Price Each	
		1-49	50-Up
SATIN-NICKEL FINISH, SILVER CONTACTS			
NC3MRC	3	\$12.25	\$6.12
NC4MRC	4	13.54	6.77
NC5MRC	5	19.40	9.70
NC6MRC	6	29.29	14.64
NC7MRC	7	34.04	22.69
BLACK CHROME FINISH, GOLD CONTACTS			
NC3MRC-B	3	15.34	7.67
BLACK CHROME FINISH, SILVER CONTACTS			
NC3MRC-BAG	3	13.35	8.90



NEUTRIK PROFI PROFESSIONAL PHONE-PLUG

The first professional phone-plug. It makes ground contact before signal contact, it breaks the signal before the ground. Spring loaded ground contacts: retracting element with separate spring contacts, gold-plated. All metal design machined brass, black finish shell. Easy to solder. High-grade plastic insulator.

Cat. No.	Description	Net Price
NF2CB-2	Pair of 2 (Black and Red) Phone Plugs, Black Finish Housing.	\$19.13



NC3MP



NC3FP-1

NEUTRIK RECEPTACLES MALE RECEPTACLES

Male panel-mounting receptacle. Satin-nickel housing, silver contacts.

FEMALE RECEPTACLES

Female panel-mounting receptacle. Spring steel latch. Satin-nickel housing, silver contacts.

MALE RECEPTACLES

Cat. No.	Pin Contacts	Net Price Each	
		1-49	50-Up
NC3MP	3	\$5.21	\$2.60
NC4MP	4	6.80	3.40
NC5MP	5	11.77	5.89
NC6MP	6	16.63	8.32

BLACK CHROME FINISH, GOLD CONTACTS

NC3MP-B	3	6.13	3.07
NC4MP-B	4	9.03	4.51
NC5MP-B	5	14.82	7.41
NC6MP-B	6	21.88	10.94

FEMALE RECEPTACLES

Cat. No.	Socket Contacts	Net Price Each	
		1-49	50-Up
NC3FP-1	3	\$6.33	\$3.16
NC4FP-1	4	11.47	5.73
NC5FP-1	5	17.52	8.76
NC6FP-1	6	23.44	11.72
NC7FP-1	7	28.45	14.22

BLACK CHROME FINISH, GOLD CONTACTS

NC3FP-B-1	3	8.45	4.22
NC4FP-B-1	4	13.61	6.80
NC5FP-B-1	5	21.64	10.82

BLACK CHROME FINISH, SILVER CONTACTS

NC3FP-BAG-1	3	8.01	4.01
-------------	---	------	------

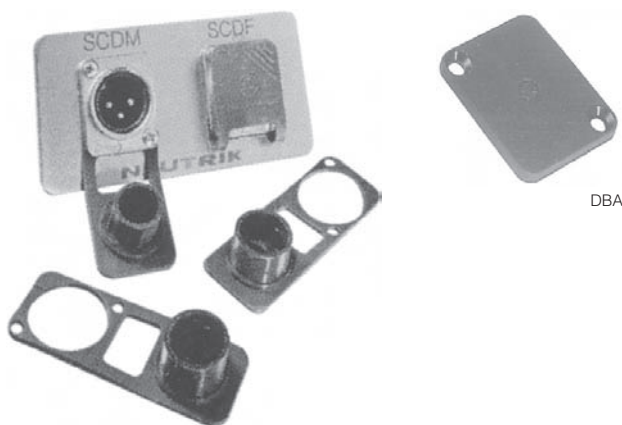

DUST COVERS FOR D SERIES-XLR TYPE CONNECTORS

Cat. No.	Description	Net Price Each		
		1-9	10-99	100-Up
SCDF	Female	\$1.32	\$0.88	\$0.66
SCDM	Male	1.32	.88	.66
DBA	Black plastic coverplate for D-size holes	1.45	.96	.72

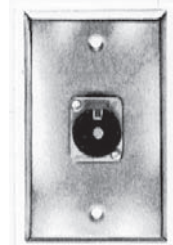
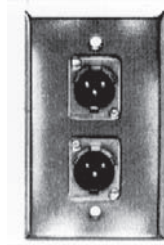

NEUTRIK WALL MOUNTING PLATES

Available as a single gang plate with single or dual receptacles. Wall mounting plates use "D" series XLR-type receptacles or lockable phone jacks. All metal, stainless steel plate.

Cat. No.	Uses Connector	Net Price Each	
		1-49	50-Up
SINGLE RECEPTACLE			
WP-101-BNC	NBB75DFI	\$20.56	\$10.28
WPP-103-F	NC3FPP	10.89	5.44
WP-103-F	NC3FD-L-1	14.00	7.00
WPP-103-M	NC3MPP	10.22	5.11
WP-103-M	NC3MD-L-1	13.59	6.79
WP-103-P	NCNJ3FP6C	18.92	9.46
WPP-103-P	NC3FP6P	16.83	8.41
DUAL RECEPTACLES			
WP-201-BNC	2XNBB75DFI	37.80	18.90
WPP-203-F	2xNC3FPP	14.82	7.41
WP-203-F	2xNC3FP-L-1	19.16	9.58
WPP-203-M	2xNC3MPP	14.19	7.10
WP-203-M	2xNC3MD-1	20.26	10.13
WP-203-P	2xNJ3FP6C	30.84	15.42
WPP-203-P	2xNJ3FP6P	26.68	13.34



NC3MPP

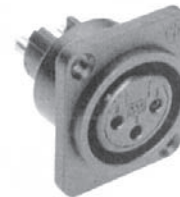

NC3FPP

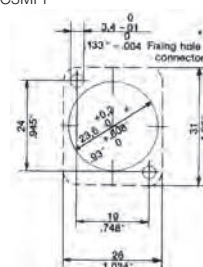

NEUTRIK PROFESSIONAL PLASTIC XLR-TYPE PANEL RECEPTACLES

These male and female receptacles are a low cost alternative to the all metal versions. They are recommended when a complete RF-protection, demanding mechanical stability and a latching possibility are of minor consideration. The female receptacle is furnished with a retention spring which also provides electrical grounding of the mating shell. Housing made of fiberglass reinforced polyester, silver contacts.

Cat. No.	Contacts	Net Price Each	
		1-49	50-Up
MALE RECEPTACLE			
NC3MPP	3	\$2.38	\$1.19
FEMALE RECEPTACLE			
NC3FPP	3	3.05	1.52

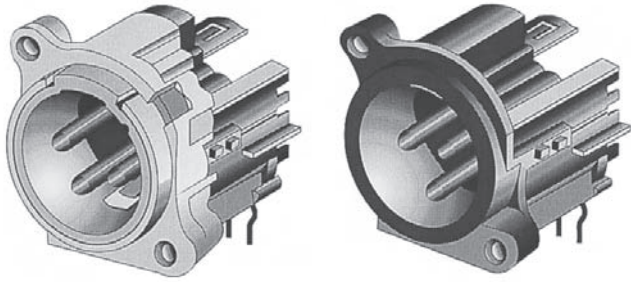

B-SERIES

A-SERIES

XLR COMPACT PANEL MOUNT RECEPTACLES

The new Neutrik A and B Series represent the ultimate in XLR-chassis connectors, they have the smallest size and highest packing density available. New to the Series is a revolutionary female contact design furnished with hard gold plating for long lasting wearability. The A-Series is made from high-impact glass reinforced UL94V-O proof plastic and the B-Series has a metal housing with mating shell contacts at the entrance to provide a complete RF-protection. The new connectors are not compatible with any existing model. Two basic grounding versions are available: (1) Pin #1, shell- and chassis ground directly connected. (2) Pin #1, shell- and chassis ground separated.

Cat. No.	Contacts	Net Price Each	
		1-49	50-Up
A-SERIES			
∅ NC3FAH-1	3	\$2.18	\$1.09
∅ NC3FAH1-0	3	1.99	1.32
∅ NC3FAH2	3	2.22	1.48
∅ NC3FAV-1	3	2.18	1.09
∅ NC3MAH	3	1.79	.90
∅ NC3MAV	3	1.73	.86
B-SERIES			
∅ NC3FBH-1	3	4.06	2.03
∅ NC3FBV-1	3	4.06	2.03
∅ NC3FBV1-0	3	3.82	2.55
∅ NC3MBH	3	3.67	1.84
∅ NC3MBV	3	3.63	1.81

Note: (-0) suffix indicates non locking type.



NEUTRIK PROFESSIONAL DIGITAL XLR-TYPE CONNECTOR

To transmit digital audio signals most efficient and reliable the necessity of perfect and continued ground connection between the cable shield and the connector shell is essential. Therefore, Neutrik has incorporated a better shield (ground) connection to the existing connectors by means of: A coaxial ground spring which gives proper connection to the male shell. A coaxial hex crimp ferrule at the cable entrance ensures proper and reliable transition of the shield to the shell.

Cat. No.	Contacts	Net Price Each	
		1-49	50-Up
∅ NC3FXCC	3	\$12.72	\$6.36
∅ NC3MXCC	3	7.95	3.97



NJ3FP6C-BAG



NJ3FC6

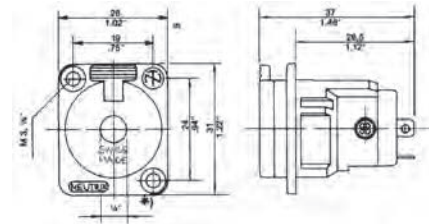

PROFESSIONAL LOCKING PHONE JACK

Automatically and securely locks standard phone plug into jack, for commercial applications where unwanted withdrawal must be prevented. Fast easy to release latch. Compatible with D-series XLR connectors. Mates and connects with all 1/4-inch 2 and 3 circuit phone plugs. All 3 contacts spring-loaded and insulated. Solder termination. Contacts: Silver-plated beryllium bronze.

Cat. No.	Finish	Version	Net Price Each	
			1-49	50-Up
∅ NJ3FP6C	Satin-Nickel	Panel	\$10.76	\$5.38
∅ NJ3FP6C-BAG	Black Chrome	Panel	11.58	5.79
∅ NJ3FP6-P-BAG	Polyester	Panel	8.81	4.41
∅ NJ3FC6	Satin-Nickel	Cable	13.56	6.78
∅ NJ3FC6-BAG	Black Chrome	Cable	14.08	7.04

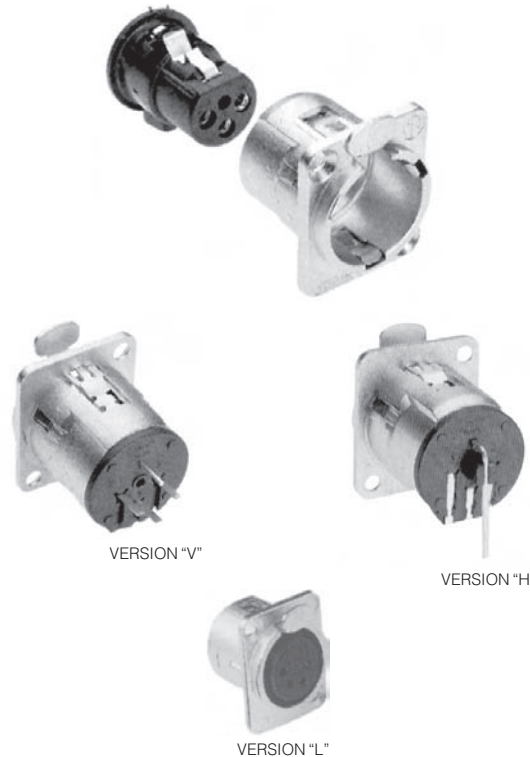

VERSION "V"

VERSION "H"

VERSION "L"

Continued on next page....



NEUTRIK D-SERIES RECEPTACLES FOR DIRECT PC BOARD MOUNTING

The Neutrik D-Series, with its new concepts for modern assembly technology has become an internationally accepted and patented standard. FEATURES: Insert mounts on printed circuit board, shell mounts on panel. Insert mates with shell from rear, locked from front without any screws. Requires less panel space (26 x 31mm). Shell can be mounted from front or rear of panel. No screws or fasteners to take out in order to remove PCB. Makes servicing faster, easier and cheaper. Connectors may be used to retain the PCB in the chassis without strain to the solder pads. Complete RF shielding via 3-point coaxial ground contact to shell of mated connector. Latch locking. New improved metal latch.

PCB HORIZONTAL MOUNT "H"

Cat. No.	Contacts	Net Price
SATIN-NICKEL FINISH, SILVER CONTACTS, MALE RECEPTACLE		
NC3MD-H	3	\$6.74
BLACK CHROME FINISH, SILVER CONTACTS, MALE RECEPTACLE		
NC3MD-H-BAG	3	7.13
SATIN-NICKEL FINISH, SILVER CONTACTS, FEMALE RECEPTACLE		
NC3FD-H	3	7.39
BLACK CHROME FINISH, SILVER CONTACTS, FEMALE RECEPTACLE		
NC3FD-H-BAG	3	8.19

PCB VERTICAL MOUNT "V"

Cat. No.	Contacts	Net Price
SATIN-NICKEL FINISH, SILVER CONTACTS, MALE RECEPTACLE		
NC3MD-V	3	\$6.74
BLACK CHROME FINISH, SILVER CONTACTS, MALE RECEPTACLE		
NC3MD-V-BAG	3	8.79
SATIN-NICKEL FINISH, SILVER CONTACTS, FEMALE RECEPTACLE		
NC3FD-V	3	7.39
BLACK CHROME FINISH, SILVER CONTACTS, FEMALE RECEPTACLE		
NC3FD-V-BAG	3	8.19

SOLDERING TERMINALS "L"

Cat. No.	Contacts	Net Price
SATIN-NICKEL FINISH, SILVER CONTACTS, MALE RECEPTACLE		
NC3MD-L-1	3	\$5.55
NC4MD-L-1	4	8.10
NC5MD-L-1	5	12.98
NC6MD-L-1	6	16.44
NC7MD-L-1	7	22.29
BLACK CHROME FINISH, SILVER CONTACTS, MALE RECEPTACLE		
NC3MD-L-BAG-1	3	7.24
BLACK CHROME FINISH, GOLD CONTACTS, MALE RECEPTACLE		
NC3MD-L-B-1	3	7.04
SATIN-NICKEL FINISH, SILVER CONTACTS, FEMALE RECEPTACLE		
NC3FD-L-1	3	5.98
NC4FD-L-1	4	10.84
NC5FD-L-1	5	16.50
NC6FD-L-1	6	22.10
NC7FD-L-1	7	26.83
BLACK CHROME FINISH, SILVER CONTACTS, FEMALE RECEPTACLE		
NC3FD-L-BAG-1	3	7.56
BLACK CHROME FINISH, GOLD CONTACTS, FEMALE RECEPTACLE		
NC3FD-L-B-1	3	7.43

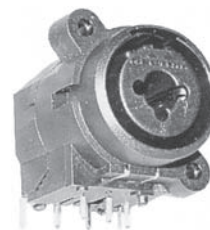

NEUTRIK PCB "COMBO CONNECTORS"

This PC Board receptacle will revolutionize Audio Equipment design. The product consists of a new 3 pole XLR-PCB receptacle with a 1/4" mono or stereo jack built into its center. The jack can be fitted with 2 or 3 gold plated contacts (R, T, S) and up to 3 normalling. The "Combo Connector" is dimensionally compatible with Neutrik K-series, the Cannon XLB and Switchcraft PQG. Substantial space and labour savings result as only one piece is inserted. The unique side brackets guarantee a strong mechanical connection to the board and the connector can be used as a means of fastening the PCB to the chassis/enclosure. Available in versions for vertical or horizontal mounting, with or without locking latch. Shell: Polyamid, PA 6.6 30% gr. Brackets: Nickel plated. Contact Area: Gold plated. Operating temperature: -20 to +65°C.

Cat. No.	Mounting	Net Price Each	
		1-49	50-Up
WITH LOCKING LATCH			
NCJ5FI-H	Horizontal	\$4.88	\$2.44
NCJ5FI-V	Vertical	4.73	2.37
NCJ6FI-H	Horizontal	4.97	2.48
NCJ6FI-V	Vertical	5.05	2.53
NCJ9FI-H	Horizontal	6.65	3.33
NCJ9FI-V	Vertical	6.65	3.33
WITHOUT LOCKING LATCH			
NCJ5FI-S	Same as NCJ* FI-V/-H but with solder cups for wire termination	4.86	2.43
NCJ6FI-S		5.25	2.62
NCJ9FI-S		6.76	3.38
NCJ10FI-S		6.93	4.62

NOTE: Available Without Locking Latch.

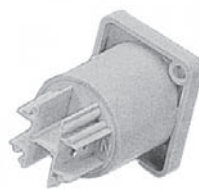

NAC3MPA
NAC3MPB



NAC3FCA
NAC3FCB

POWERCON® LOCKING 3-POLE AC CONNECTOR

Fast and easy locking system. High current capacity (20A rated/250 Volts). Extremely rugged and reliable. Meets all prevailing safety standards (cUL, UL, SEV). Colour coded A and B versions for power in or power out with different polarizing guides. Cable connectors have solid contacts with screw-type terminals. 3-pole connector system easy to assemble.

Cat. No.	Description	Net Price
NC3FCA	3 pole PowerCon twist lock AC cable connector for Power IN system. Colour: Blue	\$10.97
NC3FCB	3 pole PowerCon twist lock AC cable connector for Power OUT system. Colour: Blue and Gray	10.97
NC3MM	PowerCon inline coupler.	30.09
NC3MPA	3 pole PowerCon chassis connector, air tight, Neutrik D-, G-Series and Speakon NL4MP size compatible, for Power IN system. Colour: Blue	5.38
NC3MPB	3 pole PowerCon chassis connector, air tight, Neutrik D-, G-Series and Speakon ML4MP size compatible, for Power OUT system. Colour: Blue.	5.38



NE8MC



NE8FAH

NEUTRIK ETHERCON RJ45 DATA CONNECTORS FOR ROUGH ENVIRONMENTS

Neutrik unveils the EtherCon series a new generation of ruggedized RJ45 connectors. The first products out of the Ethercon series are a male cable connector carrier with class D channel performance and are designated for Category 5 and also a female chassis connector. EtherCon series is available shielded or unshielded and is compatible for use with 10 Base-T and 100 Base-TX systems. Ethernet has made its arrival into the entertainment industry. The EtherCon series is especially developed for audio and stage applications including DMX systems. It is also suited for harsh commercial and industrial applications and allows even outdoor internet access. The EtherCon male cable connector carrier comes along in a robust diecast shell and the unique Neutrik chuck-type strain relief for optimal cable and plug protection. The proven Neutrik quality and design makes it easy field attachable. The female chassis connector is based on the proven standard XLR A series with the secure latching system. For easy identification both male and female EtherCon are available with 9 different colour coding bushings and colour coding rings respectively.

Cat. No.	Description	Net Price
MALE CABLE CONNECTORS*		
♣ NE8MC	"D" series cable housing with chuck and bushing.	\$5.01
♣ NE8MC-1	Same as NE8MC above, but equipped with X series boot.	4.38
♣ NE8MC-B	"D" series black chromium housing with chuck and bushing.	5.90
♣ NE8MC-B-1	Same as NE8MC-B above, but equipped with X series boot.	5.01
FEMALE RECEPTACLE		
♣ NE8FAH	"A" series female receptacle for horizontal PCB mounting.	7.62
♣ NE8FBH	"B" series female receptacle for horizontal PCB mounting.	8.58
♣ NE8FAV	"A" series female receptacle for vertical PCB mounting.	7.73
♣ NE8FAV-YK	"A" series female receptacle with vertical PCB attached. IDC Krone terminals included.	15.06
♣ NE8FAV-Y110	"A" series female receptacle for vertical PCB attached. IDC 110 punch down included.	15.06
♣ NE8FBV	"B" series female receptacle for vertical PCB mounting.	8.68
♣ NE8FDP	"D" series female feed-through receptacle with metal flange. Mounting screws included.	17.80
♣ NE8FDV	"D" series female receptacle with secure latching system for vertical PCB mounting.	9.05
♣ NE8FDV-B	Black version of NE8FDV above.	9.66
♣ NE8FDV-YK	"D" series female receptacle with secure latching system for vertical PCB mounting. IDC Krone terminals included.	14.97
♣ NE8FDV-Y110	"D" series female receptacle with secure latching system for vertical PCB mounting. IDC 110 punch down included.	16.52
♣ NE8FF	CAT5 Ethercon D-size coupler; uses NE8MC connectors or standard RJ45 plugs.	30.13
♣ BSE-0	Black boot for Ethercon cable connectors. For other colours replace -0 with -2 = red, -3 = orange, -4 = yellow, -5 = green, -6 = blue, -7 = purple, -8 = grey, -9 = white.	.54
E-SCREW-1-10	Self-tapping PT-screw for Ethercon receptacles (NE8FDV-YK, NE8FDV, NE8FDV-Y110), 2.9 x 12 countersunk—black.	23.74

*Cable connector comes without RJ-45 plug, plug has to be provided by end user.



NA1394-6



NAUSB

NEUTRIK USB SERIES GENDERCHANGER TYPE CONNECTOR

The USB is a genderchanger type (USB A - USB B) which is reversible to offer both connector possibilities at the front and rear end. The Firewire is equipped with the most common IEEE1394 6-pol (Firewire 6) connector on both ends. These connectors are required to integrate computer-based equipment into sound and video systems, but also for audio networking like M-LAN, etc.

Cat. No.	No. of Contacts	Description	Net Price
NAUSB	4	USB bulk head reversible.	\$6.44
NAUSB-B	4	USB bulk head reversible, black.	7.08
NA1394-6	6	Firewire connector bulk head.	9.74
NA1394-6-B	6	Firewire connector bulk head, black.	10.22



NP2C



NP3C



NP3C-BAG



NP3TB



NP2RCS



NTP3RC



NP3TT-1

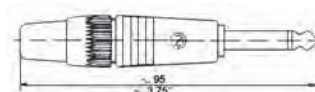
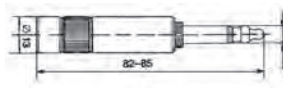

Continued on next page...

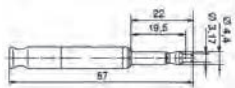

PROFESSIONAL PHONE PLUGS

The Neutrik 1/4" phone plug features a shell from die-cast zinc, a one piece, completely machined, sleeve as well as the patented Neutrik chuck-type strain relief with maximal cable protection. It accepts cables with 2.8-7mm dia. They are available in 2- or 3-pole versions, in heavy duty right-angle version and also in a "B-gauge" (BP0316 "Longframe") configuration. The new 4.4mm "Bantam" miniature plug features a simple and fast assembling technique without the use of screws, and offers an excellent cable strain relief for cables from 3-5mm dia. The design of the "Longframe" as well as the "Bantam" allows durable hard plating of the contact surfaces and guarantees a drastic increase in durability and corrosion resistance.

Cat. No.	Finish	Net Price Each	
		1-49	50-Up
1/4" 2-POLES			
NP2C	Nickel	\$5.36	\$2.68
NP2C-BAG	Black	5.98	2.99
NP2C-SP	Nickel	5.31	2.66
1/4" 2-POLES, INTERNAL LOW TO HIGH IMPEDANCE TRANSFORMER			
NP2C-T10AA	Nickel	52.19	26.09
1/4" 2-POLES, RIGHT ANGLE			
NP2RCS	Nickel	6.61	3.30
1/4" 3-POLES STEREO			
NP3C	Nickel	8.38	4.19
NP3C-BAG	Black	8.68	4.34
1/4" 3-POLES, RIGHT ANGLE STEREO			
NP3RCS	Nickel	10.95	5.48
1/4" 3-POLES, LONG FRAME			
NP3TB-B	Black	10.22	5.11
NP3TB-R	Red	10.17	5.09
4.4MM 3-POLES, BANTAM			
NP3TT-1-B	Black	10.86	5.43
NP3TT-1-R	Red	10.84	5.42
4.4MM 3-POLES, BANTAM, STANDARD RG-58 CRIMP TOOL REQUIRED			
NP3TT-P-B	Black	8.73	4.36
NP3TT-P-R	Red	8.73	4.36
NP3TT-2	Dual Bantam Plug	17.41	8.70
3.5MM 3-POLES, TINY PLUG			
NTP3RC	Nickel	3.86	3.86
NTP3RC-B	Black	5.02	5.02

CRIMPING TOOL

Hexagonal crimping tool for NP3TT-1 connectors.

Cat. No.	Net Price
HX-TT	\$879.03

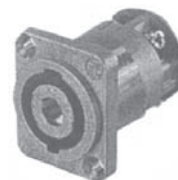
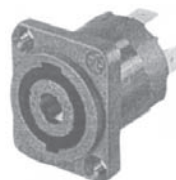
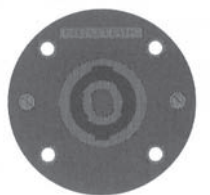

NEUTRIK "SPEAKON®" LOUDSPEAKER/AMPLIFIER CONNECTORS

Solderless, with easy assembly. Field serviceable. 4 contacts to accept wires up to 6mm (AWG 10). Current rating 30 amps RMS each contact. Voltage rating 250 Volts AC.

Cat. No.	Description	Net Price Each	
		1-49	50-Up
NL2FC	Twist Lock Speaker Cable Connector, 2 Pole	\$6.11	\$3.06
NL4FX	Twist Lock Speaker Cable Connector, 4 Pole	8.88	4.44
NL8FC	Twist Lock Speaker Cable Connector, 8 Pole	21.75	10.88
NL2MP	Chassis Connector, 2 Pole	4.10	2.74
NL4MP	Chassis Connector, 4 Pole	3.56	1.78
NL4MP-UC	40 Amp Version, Now Can Operate High Power Loudspeakers and Amplifiers Carrying More Than 1000 Watts	6.57	3.28
NL4MP-ST	Receptacle With Screw Termination. Does Not Need Special Tools For Assembly Thus it is Dedicated For Field Applications	7.24	3.62
NL4MPR	Speaker Cabinet Connector With Large Round Flange, Air Tight, 4 Pole	5.31	2.66
NL8MPR	Same as NL4MPR, Only 8 Pole	15.06	7.53
NL4MMX	In-line Coupler For Linking Cable 4 Pole	9.22	4.61
NL8MM	In-line Coupler For Linking Cable 8 Pole	32.79	16.39
NA4LJ	Speakon to 1/4" Adapter	14.04	7.02
BSL-WR	Water Resistant Gland Particularly Utilized For Outdoor Applications or Wet Environment. In Addition The Gland is Also Suitable For The Powercon Series	2.81	1.40

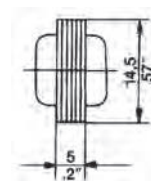
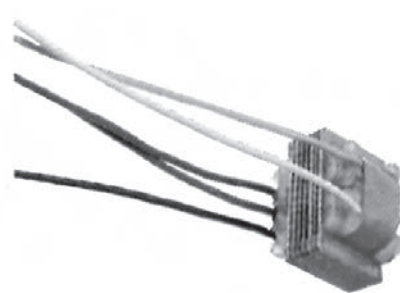

NEUTRIK TRANSFORMERS

Top quality audio transformers for multiple applications.

Cat. No.	Colour Code	Turns Ratio	Frequency Response at 200 Ohms Source	Max. Input Level 1% THD/50 Hz.	Net Price
NTE-1	Red	1:1	30-20K ±0,5 dB	600 mV	\$14.75
NTE-4	Yellow	1:4	30-20K ±1,0 dB	500 mV	17.30
NTE-10/3	Orange	1:3:10	30-20K ±1,0 dB	450 mV	13.36
NTM-1		1:1	15-25K ±0,5 dB	1,5V	81.78
NTM-4		1:4	15-25K ±0,5 dB	1,5V	84.67
NTL-1		1:1	Depending on Circuit	to + 24 dBu (Line)	94.63

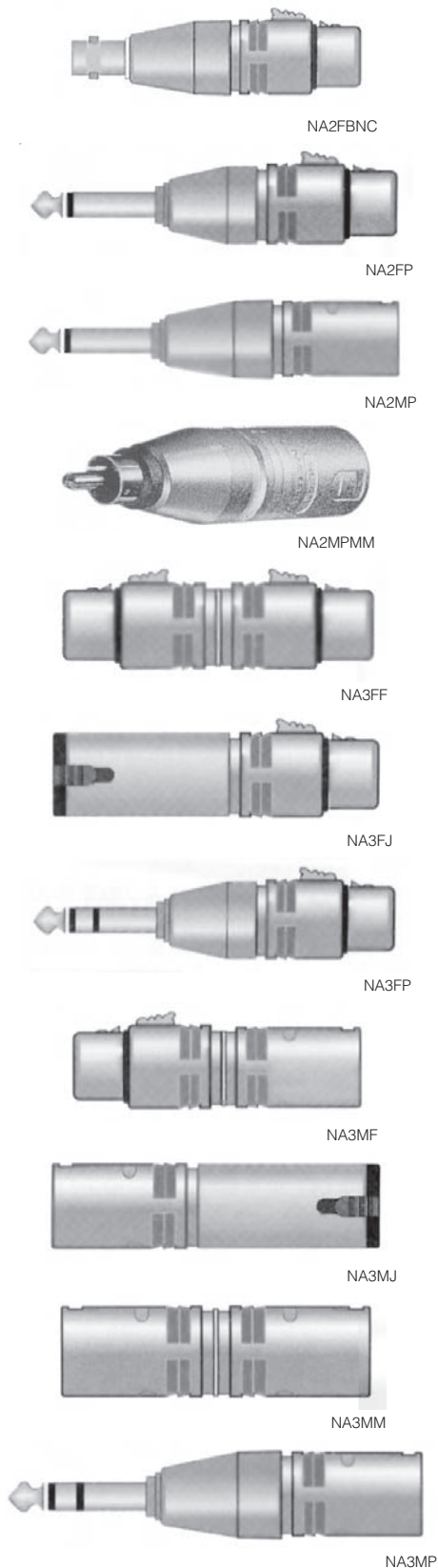

ADAPTERS AND ACCESSORIES

Neutrik adapters are versatile, pre-assembled problem solvers to interlock various connector systems or thread standards. Pin 2 is positive.

PIN 2 IN POSITIVE

Cat. No.	Function		Net Price Each	
	Input	Output	1-49	50-Up
NA2FP	XLR Female	1/4" Mono, Pin 2 Hot, Only	\$17.19	\$8.60
NA2FPMM	XLR Female	RCA Male, Pin 2 Hot, Only	18.58	9.29
NA2MP	XLR Male	1/4" Mono, Pin 2 Hot, Only	17.19	8.60
NA2MPMM	XLR Male	RCA Male, Pin 2 Hot, Only	18.58	9.29
NA3FF	XLR Female	XLR Female	15.68	7.84
NA3FJ	XLR Female	1/4" Stereo Locking Jack	22.33	11.17
NA3FP	XLR Female	1/4" Stereo, Pin 2 Hot, Only	19.38	9.69
NA3FM	XLR Male	XLR Female	15.31	10.21
NA3MJ	XLR Male	1/4" Stereo Locking Jack	22.10	11.05
NA3MM	XLR Male	XLR Male	15.40	7.70
NA3MP	XLR Male	1/4" Stereo, Pin 2 Hot, Only	19.38	9.69



NYS224
NYS224L
NYS228



NYS203
NYS204



NYS225B

NEUTRIK REAN 1/4" PROFESSIONAL PHONE PLUGS

"The lifetime plug"—designed to meet exacting industrial requirements. All plugs have a turned, very robust shell with nickel plated finish, except NYS203 and NYS204 which are plastic. No rivets. A crimp type tin plated flex relief spring for best cable protection on NYS203 and NYS204. Contact resistance: ≤ 10 m Ω . Insulation resistance: $\geq 2 \cdot 10$ m Ω . Dielectric strength: 500VDC. Temperature range: -10°C to $+70^{\circ}\text{C}$.

Cat. No.	Pole	Description	Net Price Each	
			1-9	10-Up
NYS201	2	1/4" Mono Plug Short Barrel, All Metal, No Rivets	\$1.32	\$.88
NYS202	3	1/4" Stereo Plug, All Metal, No Rivets	1.73	1.15
NYS203	2	1/4" Mono Plug, Plastic Handle and Flex Relief Spring	.86	.58
NYS204	3	1/4" Stereo Plug, Plastic Handle, Flex Relief Spring	1.22	.82
NYS224	2	1/4" Mono Plug, All Metal, No Rivets	1.82	1.22
NYS224L	2	1/4" Mono Plug For Large Cables (9.5mm dia.)	1.82	1.22
NYS225	2	1/4" Mono Plug For Large Cable (19mm dia.), Nickel Finish	3.07	2.05
NYS225B	2	1/4" Mono Plug For Large Cable (19mm dia.), Black Finish	3.07	2.05
NYS226	2	3.5mm Mono Plug with Crimp Strain Relief	1.13	.75
NYS227	3	3.5mm Mono Plug to 1/4" Jack Stereo, All Metal	3.07	2.05
NYS228	3	1/4" Stereo Plug, All Metal, No rivets	2.64	1.76
NYS231	3	Stereo Mini Plug	1.27	.85
NYS231B	3	Stereo Mini Plug, Black Finish	1.85	1.23

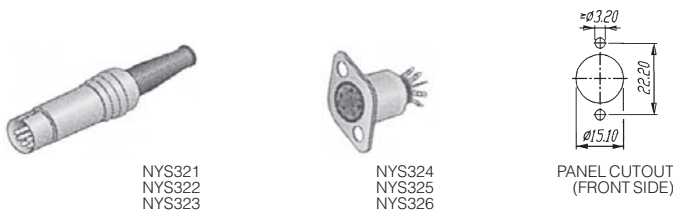

NEUTRIK REAN DIN CONNECTORS

Contact resistance: ≤ 10 m Ω . Insulation resistance: ≥ 5 -10 m Ω . Dielectric strength: 500V rms. Temperature range: -25°C to $+70^{\circ}\text{C}$.

Cat. No.	Pole	Description	Net Price Each	
			1-49	50-Up
NYS321*	3	Male DIN plug, shell turned brass, nickel finish, flexible strain relief, contacts silver plated.	\$2.02	\$1.01
NYS322*	5	Same as NYS321 above only 180°	2.06	1.03
NYS323*	7	Same as NYS321 above	2.21	1.10
NYS324	3	Female receptacles, stamped housing with nickel plated finish. Silver plated contacts. Complete shielding by ground contacts.	.79	.40
NYS325	5	Same as NYS324 above only 180°	.94	.47
NYS326	7	Same as NYS324 above	1.13	.56

*NOTE: Add "G" to Cat. No. for gold plated contacts.



NEUTRIK REAN RCA PHONO TYPES

Perfect phono plug. All metal. Phono receptacle, for PCB mounting. Phono to phono female adapter.

Cat. No.	Pole	Description	Net Price Each	
			1-49	50-Up
NYS352	2	Metal RCA plug	\$1.15	\$58
NYS352AG	2	Metal RCA plug—gold plated contact and handle	3.07	1.54
NYS352BG	2	Metal RCA plug—gold plated contacts, black plated handle	2.06	1.03
NYS352G	2	Metal RCA plug—gold plated contacts	2.06	1.03
NYS355	2	Metal RCA jack to jack adapter	1.32	.66
NYS354	2	Metal RCA PCB type	.50	.25
NYS367-0	2	RCA chassis jack, gold plated, black	2.76	1.38
NYS367-2	2	RCA chassis jack, gold plated, red	2.76	1.38
NYS367-4	2	RCA chassis jack, gold plated, yellow	2.76	1.38
NYS367-5	2	RCA chassis jack, gold plated, green	2.76	1.38
NYS367-6	2	RCA chassis jack, gold plated, blue	2.76	1.38
NYS367-9	2	RCA chassis jack, gold plated, white	2.76	1.38
NYS373-0	2	Metal RCA plug—gold plated contacts, black connector with black ring	2.66	1.33
NYS373-2	2	Metal RCA plug—gold plated contacts, black connector with red ring	2.67	1.34
NYS373-4	2	Metal RCA plug—gold plated contacts, black connector with yellow ring	2.67	1.34
NYS373-5	2	Metal RCA plug—gold plated contacts, black connector with green ring	2.67	1.34
NYS373-6	2	Metal RCA plug—gold plated contacts, black connector with blue ring	2.67	1.34
NYS373-9	2	Metal RCA plug—gold plated contacts, black connector with white ring	2.67	1.34
NYS374	2	Metal high quality RCA plug—machined, gold plated	3.08	2.46

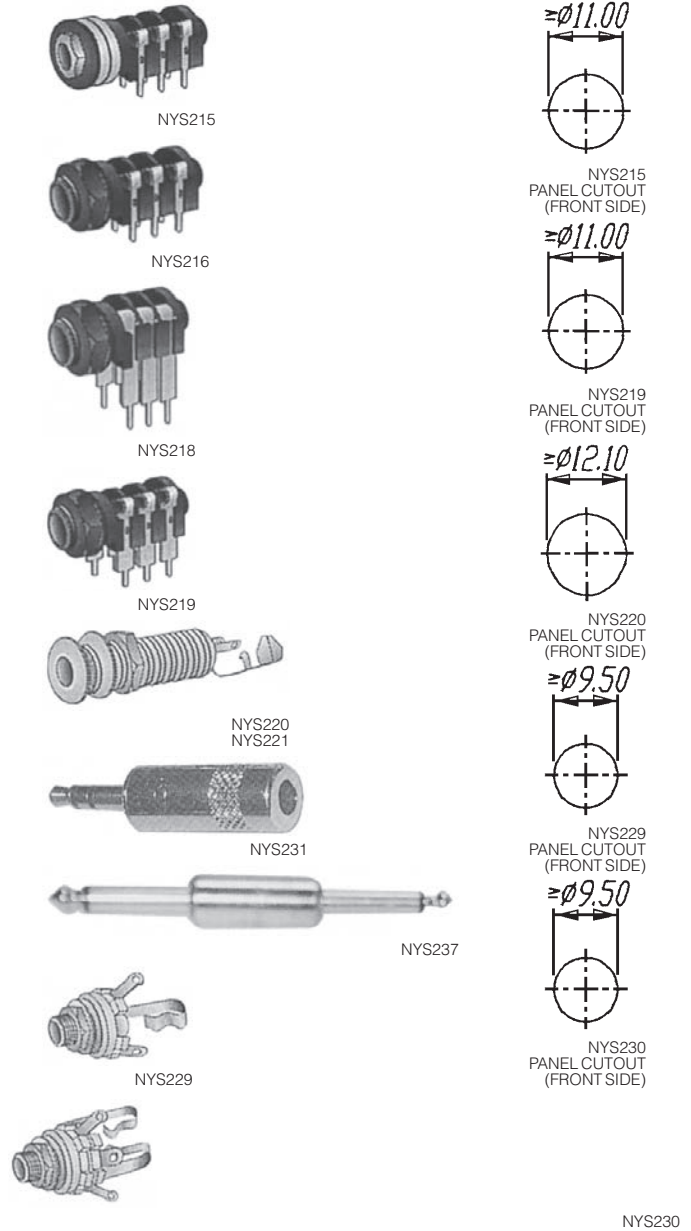

NEUTRIK CHINA 1/4" JACKS

Contact resistance: ≤ 10 m Ω . Insulation resistance: ≥ 2 -10 m Ω . Dielectric strength: 500VDC. Temperature range: -10°C to $+70^{\circ}\text{C}$.

Cat. No.	Pole	Description	Net Price Each	
			1-49	50-Up
NYS215	3	ABS 1/4" stereo jack socket, all contacts switched, metal ferrule, plastic decorative washer, PC mount, 8.2mm	\$0.98	\$0.49
NYS216	3	ABS 1/4" stereo jack socket, all contacts switched, plastic nut and washers, PC-mount, 8.2mm	.77	.38
NYS218	3	Same as NYS215 above, but 15mm	.79	.40
NYS219	3	Same as NYS215 above, but 12.5mm	.79	.40

Continued on next page....

Cat. No.	Pole	Description	Net Price Each	
			1-49	50-Up
NYS220	2	Metal 1/4" mono phone jack for thick panels, long threaded bushing with washer and nut	2.06	1.03
NYS221	3	Same as NYS220, but stereo	2.11	1.06
NYS229	2	Metal mono chassis jack, for max. panel thickness of 5.5mm, with washer and nut	1.13	.56
NYS230	3	Same as NYS229, but stereo	1.42	.71
NYS231	3	1/8" Mini Stereo Plug	1.27	.85
NYS231B	3	1/8" Mini Stereo Plug, Black Finish	1.85	.92
NYS237	3	1/4" Plug to Plug Mono.	2.57	1.28



NEUTRIK REAR BANANA PLUGS

Cat. No.	Colour	Net Price
NYS511-B	Black	\$2.16
NYS511-R	Red	2.16



NEUTRIK REAR TWIST BNC 75 OHM

Cat. No.	Description	Net Price Each	
		1-49	50-Up
NBNC75BIJ9	Rear twist type, pin with 0.9mm, bagged with black bushing. Suitable for: Belden 1506A, CommScope 2065V.	\$4.62	\$2.31
NBNC75BLP7	Rear twist type, pin with 0.7mm, bagged with black bushing. Suitable for: Belden 8241, CommScope 5563, Canare LV-61S, RG59B/U, Nokia 0.6/3.7.	4.62	2.31
NBNC75BXY9	Rear twist type, pin with 0.9mm, bagged with black bushing. Suitable for: Belden 8281.	4.62	2.31

CRIMP TOOLS AND DIES FOR BOTH REAR TWIST AND PUSH-PULL BNC CONNECTORS ARE AVAILABLE UPON REQUEST



NEUTRIK PUSH-PULL BNC 75 OHM

Cat. No.	Description	Net Price Each	
		1-49	50-Up
NBNC75PIE9	The pin has a hole for the center conductor of 0.9mm. Suitable for: Belden 1506A, CommScope 2065V.	\$8.21	\$4.10
NBNC75PNS7	The pin has a hole for the center conductor of 0.7mm. Suitable for: Belden 8241, Suhner GO4233D, Canare LV61S, RG59B/U.	8.21	4.10
NBNC75PTS11	The pin has a hole for the center conductor of 1.1mm. Suitable for: Belden 1694A, CommScope 5765, Suhner S05133-07, Gepco USD2001.	8.21	4.10

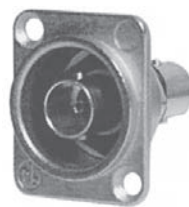

NBB75DFI



NBB75FI

75 OHM BNC BULKHEAD JACKS

Cat. No.	Description	Net Price Each	
		1-49	50-Up
BNC BULKHEAD JACKS CHASSIS MOUNT			
NBB75DFI	D-size housing, feed through, isolated	\$13.54	\$6.77
NBB75DFIB	Same as NBB75DFI, but black D-size housing	14.17	7.08
NBB75DFG	D-size housing, feed through, grounded	13.28	6.94
NBB75DFGB	Same as NBB75DFG, but black D-size housing	14.56	7.28
BNC BULKHEAD JACKS			
NBB75FI	Feed through, isolated	10.91	5.45
NBB75FG	Feed through, grounded	11.34	5.67

electro sonic

Electro Sonic
appreciates your business

1-800-56-SONIC

www.e-sonic.com

info@e-sonic.com



NEUTRIK MONO MALE 1/4" BOTH ENDS, WITH DIGIFLEX NK 1/6 CABLE

Cat. No.	Length ft.	Net Price Each		
		1-9	10-99	100-Up
NPP-1	1	\$12.80	\$9.85	\$9.14
NPP-3	3	13.70	10.54	9.79
NPP-6	6	15.48	11.91	11.06
NPP-10	10	14.78	11.37	10.56
NPP-15	15	19.52	15.02	13.94
NPP-20	20	21.76	16.74	15.54
NPP-25	25	24.00	18.46	17.14
NPP-50	50	35.24	27.11	25.17



NEUTRIK STEREO 1/4" BOTH ENDS, WITH DIGIFLEX NK 2/6 CABLE

Cat. No.	Length ft.	Net Price Each		
		1-9	10-99	100-Up
NSS-1	1	\$18.48	\$14.22	\$13.20
NSS-3	3	19.28	14.83	13.17
NSS-6	6	20.48	15.75	14.63
NSS-10	10	22.46	17.28	16.04
NSS-15	15	24.86	19.12	17.76
NSS-20	20	27.14	20.88	19.39
NPP-25	25	30.12	23.17	21.31
NSS-50	50	40.82	31.40	29.16



NEUTRIK 0.173" BANTAM BOTH ENDS, WITH CANARE L-4E5C CABLE

Cat. No.	Length ft.	Net Price Each		
		1-9	10-99	100-Up
TT-1-P-BLACK	1	\$27.06	\$20.82	\$19.33
TT-1.5-P-BLACK	1.5	27.52	21.17	19.86
TT-2-P-BLACK	2	27.92	21.92	19.94
TT-3-P-BLACK	3	28.84	22.18	20.60
TT-4-P-BLACK	4	29.72	22.86	21.23
TT-6-P-BLACK	6	31.44	24.18	22.46



NEUTRIK 1/4" LONGFRAME BOTH ENDS, WITH CANARE L-4E6S CABLE

Cat. No.	Length ft.	Net Price Each		
		1-9	10-99	100-Up
LF-1-BLACK	1	\$26.32	\$20.25	\$18.80
LF-1.5-BLACK	1.5	26.82	20.63	19.16
LF-2-BLACK	2	27.30	21.00	19.50
LF-3-BLACK	3	28.28	21.75	20.20
LF-4-BLACK	4	29.48	22.68	21.06
LF-4-BLACK	4	29.48	22.68	21.06



STUDIO QUALITY CANARE F10 RCA CONNECTOR BOTH ENDS, WITH CANARE GS-6 CABLE

Cat. No.	Length ft.	Net Price Each		
		1-9	10-99	100-Up
CFF-1-BLACK	1	\$25.30	\$19.46	\$18.07
CFF-3-BLACK	3	28.10	21.62	20.07
CFF-6-BLACK	6	32.30	24.85	23.07
CFF-10-BLACK	10	36.86	28.35	26.33
CFF-15-BLACK	15	47.56	36.58	33.97
CFF-20-BLACK	20	55.24	42.49	39.46



AUDIOPHILE GRADE NEUTRIK NF2CB MALE RCA BOTH ENDS, WITH GS-6 CABLE

Cat. No.	Length ft.	Net Price Each		
		1-9	10-99	100-Up
CNN-1-BLACK	1	\$35.96	\$27.66	\$25.69
CNN-3-BLACK	3	39.04	30.03	27.89
CNN-6-BLACK	6	43.64	33.57	31.17
CNN-10-BLACK	10	33.28	25.60	23.77
CNN-15-BLACK	15	40.60	31.23	29.00
CNN-20-BLACK	20	47.40	36.85	34.21



NEUTRIK FEMALE TO MALE XLR CONNECTOR, WITH DIGIFLEX NK 2/6 CABLE

Cat. No.	Length ft.	Net Price Each		
		1-9	10-99	100-Up
N3-XX	3	\$16.54	\$12.72	\$11.81
N6-XX	6	17.04	13.11	12.17
N10-XX	10	12.26	13.28	12.33
N15-XX	15	21.46	16.52	15.34
N25-XX	25	23.16	17.82	16.54
N35-XX	35	30.00	23.08	21.43
N50-XX	50	39.52	30.40	28.23
N75-XX	75	52.42	40.32	37.44
N100-XX	100	62.32	56.25	46.66



NEUTRIK SPEAKON CONNECTOR, WITH DIGIFLEX SPEAKER CABLE

Cat. No.	Length ft.	Net Price Each		
		1-9	10-99	100-Up
D-14/2+NL4				
L5-2-14-N4	5	\$29.48	\$22.68	\$21.06
L10-2-14-N4	10	33.50	25.77	23.93
L25-2-14-N4	25	37.00	28.46	26.43
L35-2-14-N4	35	43.54	33.49	31.10
L50-2-14-N4	50	54.66	42.05	39.04
L75-2-14-N4	75	65.20	50.15	46.67
L100-2-14-N4	100	80.56	61.97	57.54
D-14/4+NL4				
L5-4-14-N4	5	32.46	24.97	23.19
L10-4-14-N4	10	39.20	30.15	28.00
L25-4-14-N4	25	54.66	42.05	39.04
L35-4-14-N4	35	63.92	49.17	45.66
L50-4-14-N4	50	80.18	61.68	57.27
L75-4-14-N4	75	99.84	76.80	71.31
L100-4-14-N4	100	123.94	95.34	88.53



MAXI UNIVERSAL ADAPTER KIT

The Maxi Adapter Kit contains 2 pcs. each: BNC Male, BNC Female, TNC Male, TNC Female, SMA Male, SMA Female, "N" Male, "N" Female, UHF Male, UHF Female, Mini UHF Male, Mini UHF Female, "F" Male, "F" Female, RCA Male, RCA Female, six intermediate Couplers, one Double Banana Plug, one Double Banana Jack and one Sampler.

Cat. No.	Net Price
5748	\$316.04

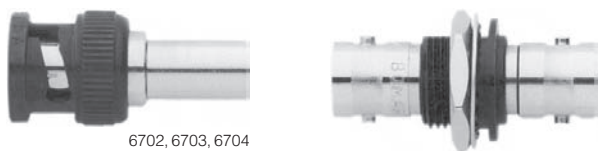

6702, 6703, 6704

6705

HIGH DEFINITION 75Ω BNC CONNECTORS

Designed for minimum return loss. Optimized for performance at HDTV and broadband frequencies. **MATERIALS:** BNC: Shell: tarnish resistant black nickel plated brass; Centre Contact: male: gold plated brass; female: gold plated beryllium copper.

Cat. No.	Type	For Cable	Net Price
6702	BNC (m)	RG59B/U, 20 AWG	\$1.52
6703	BNC (m)	RG6B/U, 18 AWG	1.52
6704	BNC (m)	RG59B/U, 23 AWG	1.47
6705	BNC (f/f)	Panel Connector	15.23



MODEL 5109 FEMALE AUDIO CONNECTOR

FEATURES: Straight cord, 3 conductor. Mates to Model #5117 wall mount male receptacle. Will accept standard 3 pin XLR male jacks. Withstands up to 45.35 Kg (100 lbs.) of pull. Durable Zinc alloy housing. Accepts up to 14 AWG wire. **MATERIALS:** Housing: Zinc or Aluminum Alloy with a nickel finish. Contacts: Copper Alloy with a silver plate finish. Barrel: Steel with nickel plating. Insulator & Bushing: Grey Elastomer. **RATINGS:** Operating Voltage: 133 VRMS/DC. Current: 15 Amps.

Cat. No.	Net Price
5109	\$3.73

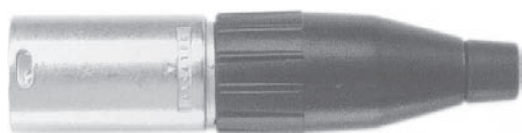

MODEL 5110 MALE AUDIO CONNECTOR

FEATURES: Straight cord, 3 conductor. Withstands up to 45.35 Kg (100 lbs.) of pull. Mates to Model #5113 wall mount female receptacle. Will accept standard 3 pin XLR female jacks. Durable Zinc alloy housing. Accepts up to 14 AWG wire. **MATERIALS:** Housing: Zinc Alloy with a nickel finish. Contacts: Bronze with a tin plate finish. Cable Relief: Elastomer. Insulator: Polyester. **RATINGS:** Operating Voltage: 133 VRMS/DC. Current: 15 Amps.

Cat. No.	Net Price
5110	\$3.73



POMONA THREE XLR AUDIO CONNECTORS FOR ACCESS VIA 5-WAY BINDING POSTS

This adapter makes it easy to spit out the signals from the three XLR audio conductors for access via 5-way binding posts. RJ11 jack also simplifies connection to phone for ring down tests of audio lines for phone communications across audio cables. Includes three colour-coded 5-way binding posts for high, low, and ground terminals. Cables can be connected to rugged binding posts via banana plug, spade lugs, alligator clip, or simply fed into the through-hole or wrapped around the post.

Cat. No.	Description	Net Price
7288	XLR (M) triple binding posts to RJ11	\$63.00
7286	XLR (M) triple binding post	52.00
7289	XLR (F) triple binding post to RJ11	63.00
7287	XLR (F) triple binding post	52.00

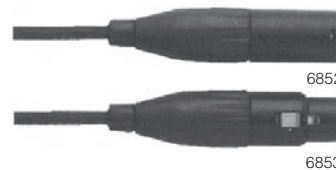

6852

6853

AUDIO CABLE ASSEMBLIES

The Pomona 6902 Series Audio Cables provide reliable, durable audio connections with cable assemblies tested to over 100 pounds pull and up to 50,000 bends under stress. Pomona assemblies are constructed for durability, using our best XLR connectors and Belden 1172A Starquad Audio Cable for low-noise service.

Cat. No.	Description	Net Price
6902-120	XLR Plug to XLR Jack 10 ft.	\$36.01
6902-180	XLR Plug to XLR Jack 15 ft.	40.64
6902-240	XLR Plug to XLR Jack 20 ft.	45.25
6902-300	XLR Plug to XLR Jack 25 ft.	49.88

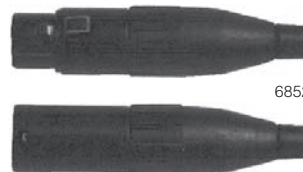

6852

6853

MODEL 6852 & 6853 XLR CONNECTORS

Pomona's rugged XLR connectors deliver dependable cable retention. The 6852 and 6853 are specially designed for strenuous use where cable separation cannot be tolerated. **FEATURES:** 3 conductor. Designed with an internal cable clamp for superior cable retention. **MATERIALS:** Body: Diecast Zinc Alloy with tarnish resistant nickel plating. Black Nickel plating for low reflection. **RATINGS:** Operating Voltage: 133 VRMS/DC. Current: 15 Amps.

Cat. No.	Description	Net Price
6852	Female Connector, 3 gold plated contacts	\$4.35
6853	Male Connector, 3 gold plated contacts	4.35

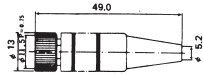

MINIATURE CONNECTOR

Precision miniature inline plug with gold plated contacts.

MINIATURE INLINE PLUG

Cat. No.	Description	Net Price
25-746-0	6 pos.	\$6.95

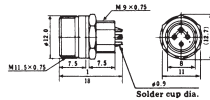

Precision chassis jack with gold plated contacts.

MINIATURE CHASSIS JACK

Cat. No.	Description	Net Price
25-756-0	6 pos.	\$8.33



AUDIO ADAPTERS RCA JACK—RCA JACK

Cat. No.	Net Price
27-116-0	\$3.37



RCA JACK—RCA JACK (GOLD PLATED)

Cat. No.	Net Price
27-117-0	\$5.50



RCA JACK—1/4" PHONE PLUG

Cat. No.	Net Price
27-162-0	\$6.68



3.5MM JACK—RCA PLUG

Cat. No.	Net Price
27-312-0	\$8.83



3.5MM JACK—1/4" PHONE PLUG

Cat. No.	Net Price
27-362-0	\$1.00



3.5MM STEREO JACK—1/4" STEREO PLUG

Cat. No.	Net Price
27-455-0	\$7.75



3.5MM STEREO JACK—1/4" MONO PLUG

Cat. No.	Net Price
27-464-0	\$6.67



1/4" STEREO JACK—3.5MM STEREO PLUG

Cat. No.	Net Price
27-533-0	\$8.80



RCA COAXIAL CABLES

RCA plug to RCA plug with RG59/U cable.

Cat. No.	Length	Net Price
28-106G-0	6' Length Gold	\$1.85
28-112-0	12' Length	2.60
28-125-0	25' Length	5.08



AUDIO CABLES

RCA 'Y' CABLES

Cat. No.	Description	Net Price
27-912-0	1 RCA Plug to 2 RCA Jacks 6" long.	\$8.88
27-921-0	1 RCA Jack to 2 RCA Plugs 6" long.	.87



MISC. 'Y' CABLES

2 RCA plugs and 3.5mm stereo plug 6" long.

Cat. No.	Net Price
27-974-0	\$1.50



RCA PLUG—RCA PLUG

6' long RCA plug to RCA plug Audio Cable.

Cat. No.	Net Price
28-211-0	\$9.95



3.5MM PLUG—3.5MM PLUG

3.5mm plug to 3.5mm plug Audio Cable.

Cat. No.	Description	Length (ft)	Net Price
28-233-0	Mono	6	\$1.30
28-234-0	Stereo	6	1.30
28-235-0	Stereo	12	1.91



3.5MM CABLE

3.5mm stereo plug to 3.5mm stereo jack.

Cat. No.	Length	Net Price
28-244-0	6' Length	\$1.45
28-245-0	12' Length	1.63
28-246-0	25' Length	3.75



S-VHS CABLES

Gold plated.

Cat. No.	Length	Net Price
28-306-0	6' Length	\$3.67
28-312-0	12' Length	4.33
28-325-0	25' Length	7.00



S-VHS PATCH CABLES

S-VHS + Stereo Audio extension cables, gold plated.

Cat. No.	Length	Net Price
28-320-0	6' Length	\$7.00
28-321-0	12' Length	8.67



S-VHS JOINER

Gold plated.

Cat. No.	Net Price
28-366-0	\$3.00



RCA 'Y' ADAPTER

One RCA plug to 2 RCA jacks.

Cat. No.	Net Price
27-913-0	\$1.12



STEREO AUDIO ADAPTERS

3.5mm stereo plug to 2 3.5mm stereo jacks.

Cat. No.	Net Price
27-933-0	\$1.45



STEREO AUDIO CABLES

Two RCA plugs to two RCA plugs.

Cat. No.	Description	Net Price
28-511-0	3' Long	\$1.17
28-611-0	6' Long	1.40
28-711-0	12' Long	2.08
28-811-0	20' Long	3.13

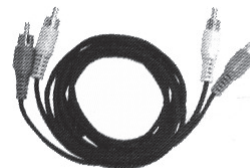

STEREO AUDIO CABLES (GOLD PLATED)

Two RCA plugs to two RCA plugs (gold plated).

Cat. No.	Description	Net Price
28-512-0	3' Long	\$1.50
28-612-0	6' Long	1.97
28-712-0	12' Long	2.42
28-812-0	20' Long	4.83



GOLD PLATED VIDEO CABLES

Gold plated video cables—two audio lines plus shielded video line.

Cat. No.	Description	Net Price
28-411-0	3' Long	\$3.58
28-412-0	6' Long	4.17
28-413-0	12' Long	5.83
28-414-0	18' Long	8.42
28-415-0	20' Long	11.33



18 GAUGE SPEAKER WIRE

500' spool of 18 gauge speaker wire. Clear jacket.

Cat. No.	Net Price
01-0244-500	\$63.33

LOCKING HARDWARE

SPECIFICATIONS:

MATERIAL:

Shell: Yellow chromate plated steel
Contacts: Brass (gold plated over nickel)
Insulator: PBT & glass-fibre re-inforced UL94V-0

ELECTRICAL:

Current rating: 5 amps
Working voltage: 125V RMS
Dielectric Strength: 1000V for 1 minute
Insulation Resistance: 1000MΩ @ 500VDC
Temperature Range: -55°C to +105°C



30-023-0



30-028-0

Cat. No.	Description	Net Price Per 100
30-023-0	Lock Posts (set of 2)	\$25.75
30-028-0	Lock Screws (set of 2)	25.75