

4 A - 200 V power Schottky rectifier

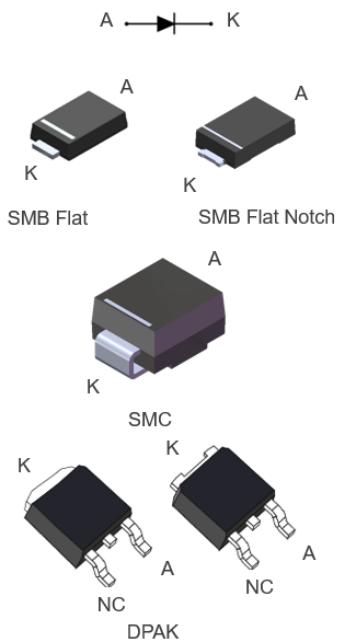

Features

- Negligible switching losses
- High junction temperature capability
- Very small conduction losses
- Low leakage current
- $T_j = -40\text{ }^\circ\text{C}$ minimum operating
- **ECOPACK2** component

Applications

- Inverter
- Lighting
- Battery charger
- Telecom power
- Home appliance

Description

Single chip Schottky rectifier suited for switch mode power supplies and high frequency DC to DC converters.

Packaged in SMB Flat Notch, SMB Flat, SMC and DPAK, the **STPS4S200** is ideal for surface mounting and used in low voltage, high frequency inverters, free wheeling and polarity protection applications.

Product status	
STPS4S200	
Product summary	
Symbol	Value
$I_{F(AV)}$	4 A
V_{RRM}	200 V
$T_{j(max.)}$	175 °C
$V_{F(typ.)}$	0.64 V

1 Characteristics

Table 1. Absolute ratings (limiting values at 25 °C, unless otherwise specified)

Symbol	Parameter		Value	Unit	
V_{RRM}	Repetitive peak reverse voltage		200	V	
$I_{F(RMS)}$	Forward rms current		10	A	
$I_{F(AV)}$	Average forward current, $\delta = 0.5$, square wave	SMB Flat Notch, SMC, SMB Flat	$T_L = 125\text{ °C}$	4	A
		DPAK	$T_C = 160\text{ °C}$		
I_{FSM}	Surge non repetitive forward current		$t_p = 10\text{ ms}$ sinusoidal	130	A
T_{stg}	Storage temperature range			-65 to +175	°C
T_j	Operating junction temperature range ⁽¹⁾			-40 to +175	°C

1. $(dP_{tot}/dT_j) < (1/R_{th(j-a)})$ condition to avoid thermal runaway for a diode on its own heatsink.

Table 2. Thermal resistance parameter

Symbol	Parameter	Max. value	Unit
$R_{th(j-l)}$	Junction to lead (SMB Flat Notch, SMC, SMB Flat)	15	°C/W
$R_{th(j-c)}$	Junction to case	3.2	

For more information, please refer to the following application note :

- AN5088 : Rectifiers thermal management, handling and mounting recommendations

Table 3. Static electrical characteristics

Symbol	Parameter	Test conditions	Min.	Typ.	Max.	Unit
$I_R^{(1)}$	Reverse leakage current	$T_j = 25\text{ °C}$	-		5	μA
		$T_j = 125\text{ °C}$	-	0.70	2.50	mA
$V_F^{(2)}$	Forward voltage drop	$T_j = 25\text{ °C}$	-		0.87	V
		$T_j = 125\text{ °C}$	-	0.64	0.71	

1. Pulse test: $t_p = 5\text{ ms}$, $\delta < 2\%$

2. Pulse test: $t_p = 380\text{ μs}$, $\delta < 2\%$

To evaluate the conduction losses, use the following equation:

$$P = 0.63 \times I_{F(AV)} + 0.020 \times I_{F(RMS)}^2$$

For more information, please refer to the following application notes related to the power losses :

- AN604: Calculation of conduction losses in a power rectifier
- AN4021: Calculation of reverse losses on a power diode

1.1 Characteristics (curves)

Figure 1. Average forward power dissipation versus average forward current

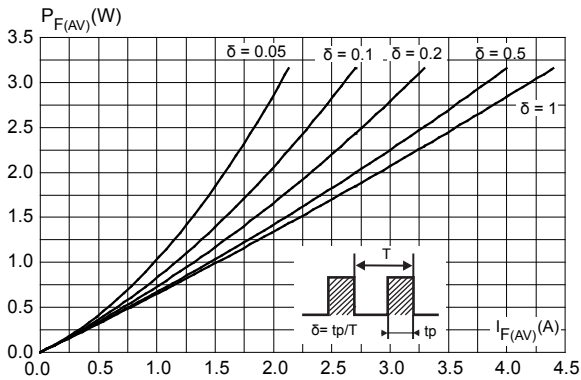

Figure 2. Average forward current versus ambient temperature ($\delta = 0.5$)

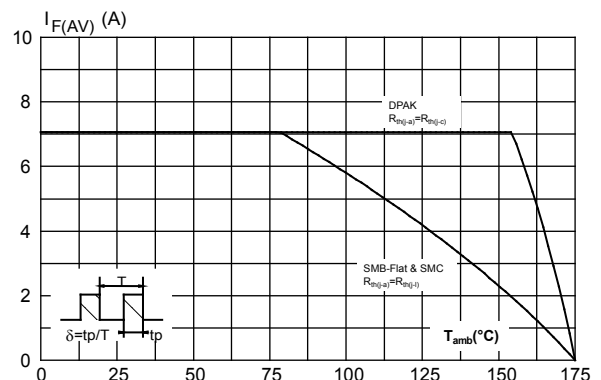

Figure 3. Normalized avalanche power derating versus pulse duration ($T_j = 125\text{ °C}$)

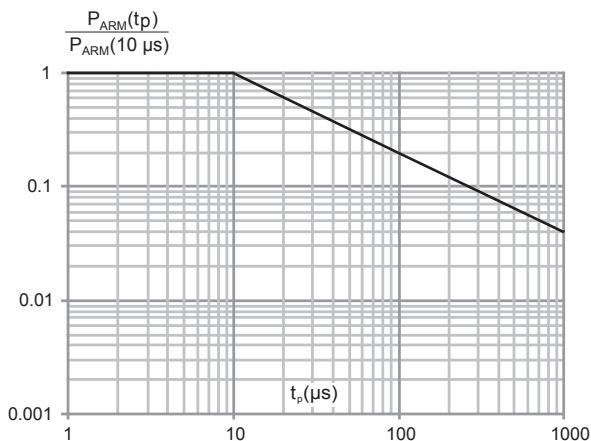

Figure 4. Relative variation of thermal impedance junction to case versus pulse duration (DPAK)

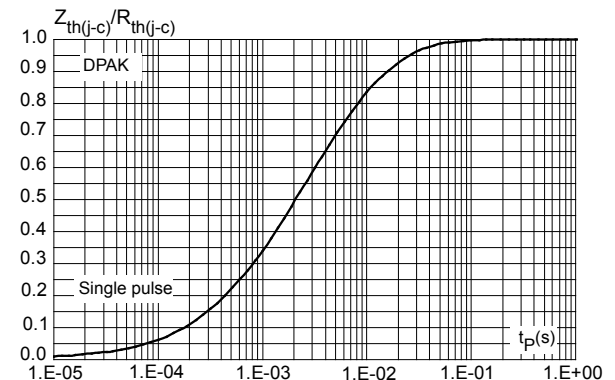

Figure 5. Relative variation of thermal impedance junction to lead versus pulse duration (SMB flat, SMB flat Notch)

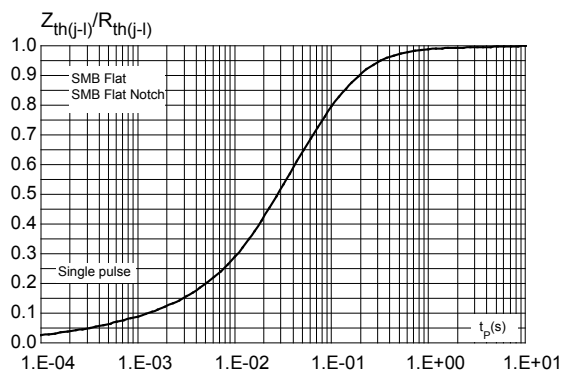

Figure 6. Relative variation of thermal impedance junction to lead versus pulse duration (SMC)

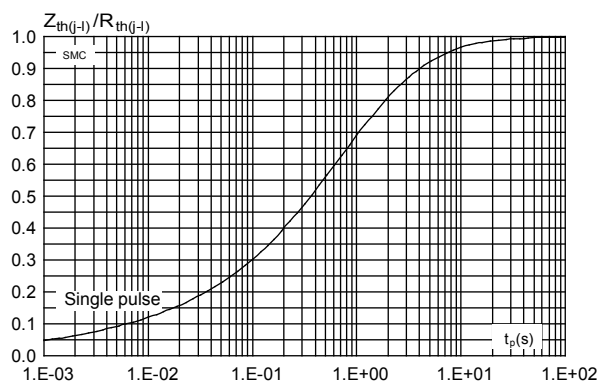

Figure 7. Reverse leakage current versus reverse voltage applied (typical values)

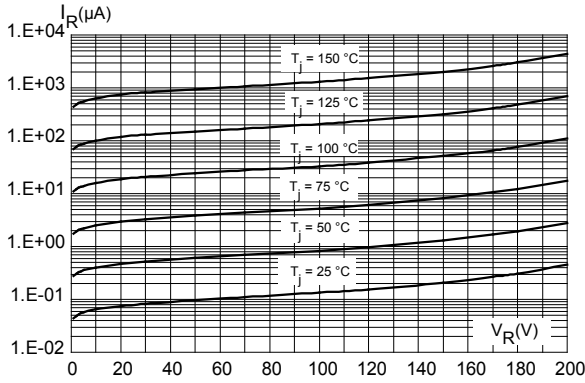

Figure 8. Junction capacitance versus reverse voltage applied (typical values)

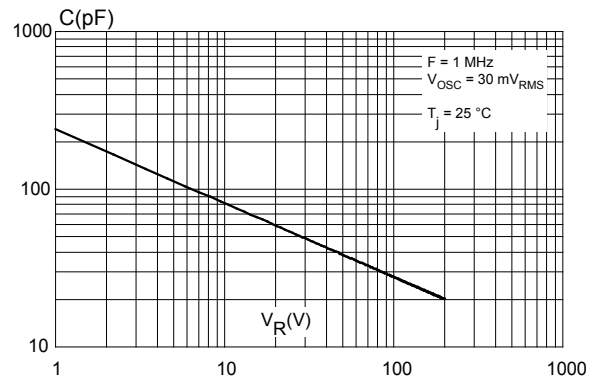

Figure 9. Forward voltage drop versus forward current (typical values)

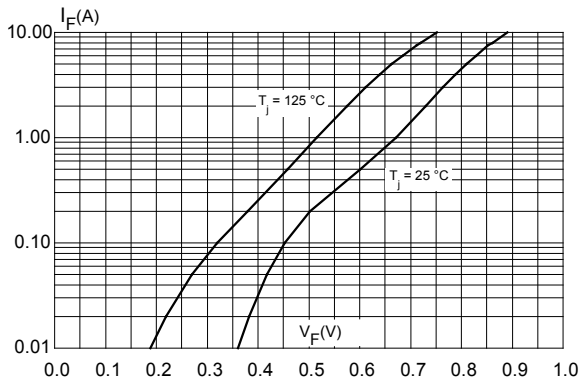

Figure 10. Forward voltage drop versus forward current (maximum values)

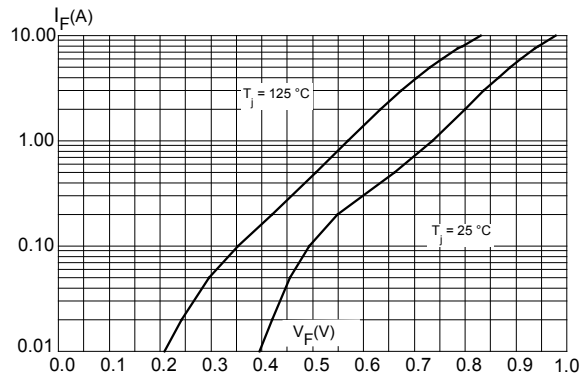

Figure 11. Thermal resistance junction to ambient versus copper surface under tab (DPAK)

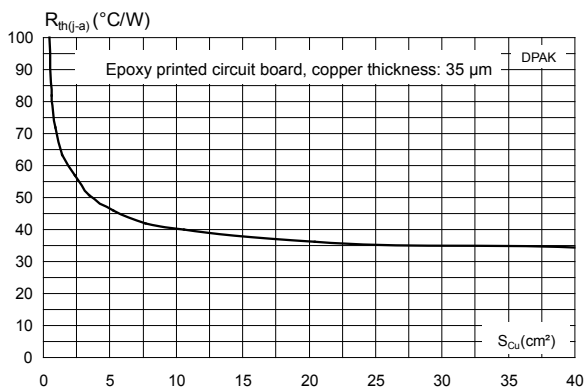

Figure 12. Thermal resistance junction to ambient versus copper surface under each lead (SMB Flat, SMB Flat Notch)

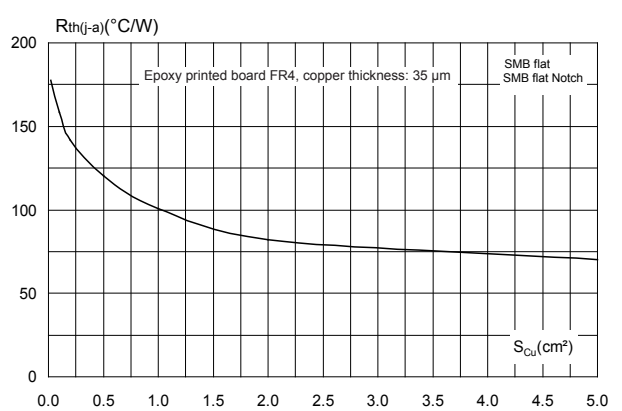
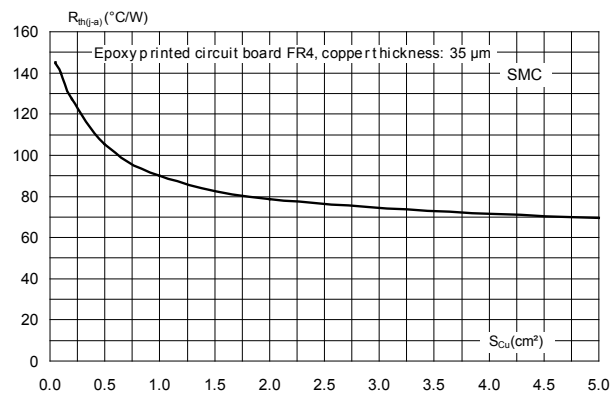

Figure 13. Thermal resistance junction to ambient versus copper surface under each lead (SMC)



2 Package information

In order to meet environmental requirements, ST offers these devices in different grades of **ECOPACK** packages, depending on their level of environmental compliance. ECOPACK specifications, grade definitions and product status are available at: www.st.com. ECOPACK is an ST trademark.

2.1 SMB Flat Notch package information

- Epoxy meets UL94, V0
- Lead-free package

Figure 14. SMB Flat Notch package outline

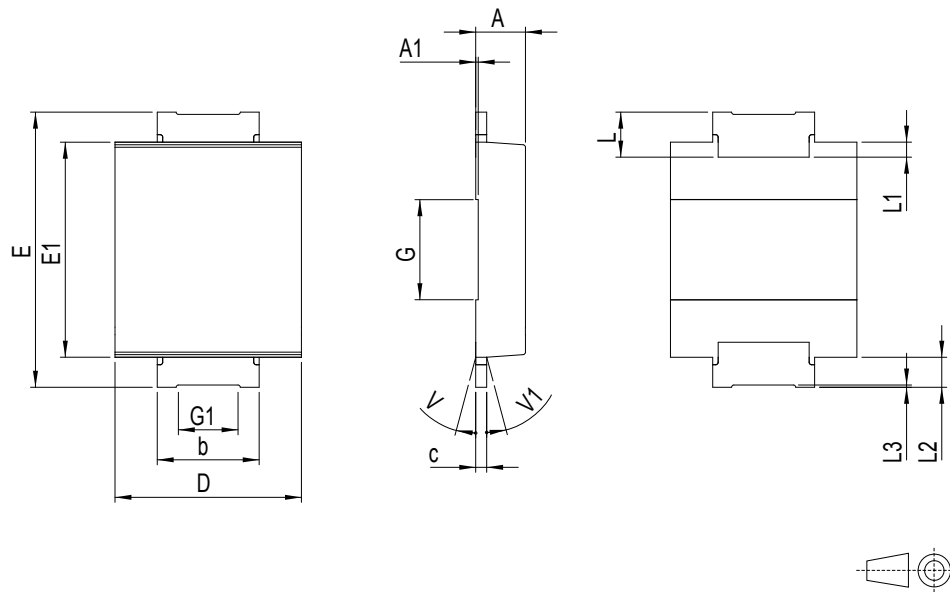
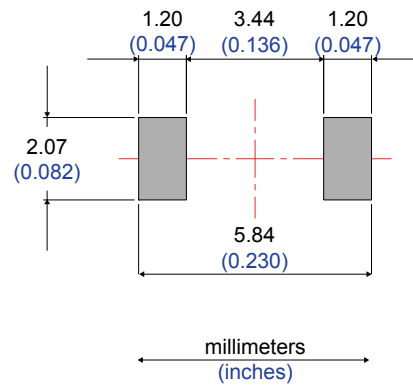

Table 4. SMB Flat Notch mechanical data

Ref.	Dimensions					
	Millimeters			Inches		
	Min.	Typ.	Max.	Min.	Typ.	Max.
A	0.90		1.10	0.035		0.043
A1		0.05			0.002	
b	1.95		2.20	0.077		0.087
c	0.15		0.40	0.006		0.016
D	3.30		3.95	0.130		0.156
E	5.20		5.60	0.205		0.220
E1	4.05		4.60	0.159		0.181
G		2.00			0.079	
G1		1.20			0.047	
L	0.75		1.20	0.030		0.047
L1		0.30			0.012	
L2		0.60			0.024	
L3	0.02			0.001		
V			8°			8°
V1			8°			8°

Figure 15. Footprint recommendations, dimensions in mm (inches)



2.2 SMB Flat package information

- Epoxy meets UL94, V0
- Lead-free package

Figure 16. SMB Flat package outline

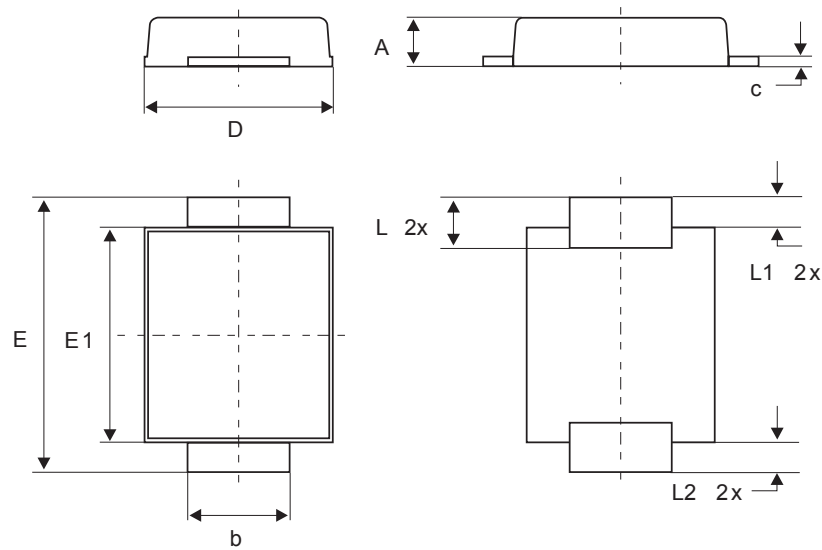
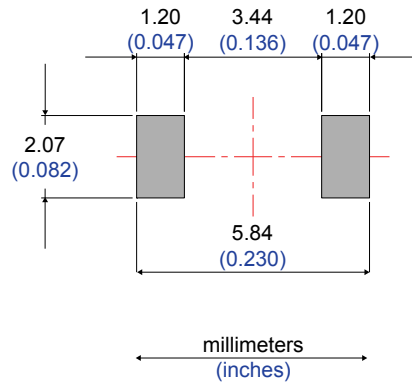

Table 5. SMB Flat mechanical data

Ref.	Dimensions					
	Millimeters			Inches		
	Min.	Typ.	Max.	Min.	Typ.	Max.
A	0.90		1.10	0.035		0.044
b	1.95		2.20	0.076		0.087
c	0.15		0.40	0.005		0.016
D	3.30		3.95	0.129		0.156
E	5.10		5.60	0.200		0.221
E1	4.05		4.60	0.159		0.182
L	0.75		1.50	0.029		0.060
L1		0.40			0.016	
L2		0.60			0.024	

Figure 17. Footprint recommendations, dimensions in mm (inches)



2.3 SMC package information

- Epoxy meets UL94, V0

Figure 18. SMC package outline

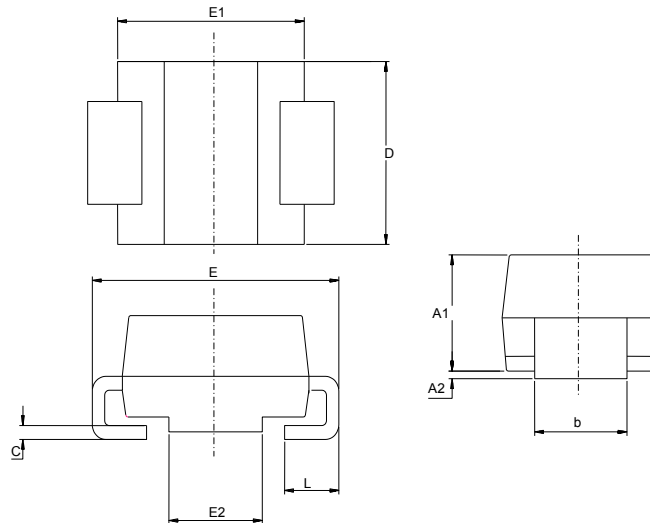
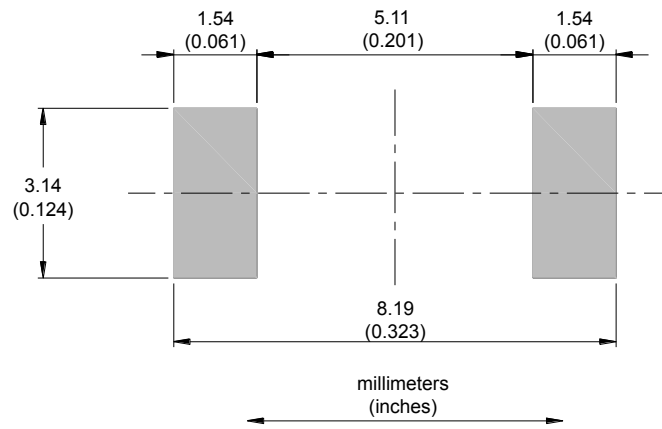

Table 6. SMC package mechanical data

Ref.	Dimensions			
	Millimeters		Inches (for reference only)	
	Min.	Max.	Min.	Max.
A1	1.90	2.45	0.0748	0.0965
A2	0.05	0.20	0.0020	0.0079
b	2.90	3.20	0.1142	0.1260
c	0.15	0.40	0.0059	0.0157
D	5.55	6.25	0.2185	0.2461
E	7.75	8.15	0.3051	0.3209
E1	6.60	7.15	0.2598	0.2815
E2	4.40	4.70	0.1732	0.1850
L	0.75	1.50	0.0295	0.0591

Figure 19. SMC recommended footprint



2.4 DPAK package information

- Epoxy meets UL 94,V0
- Cooling method: by conduction (C)

Figure 20. DPAK package outline

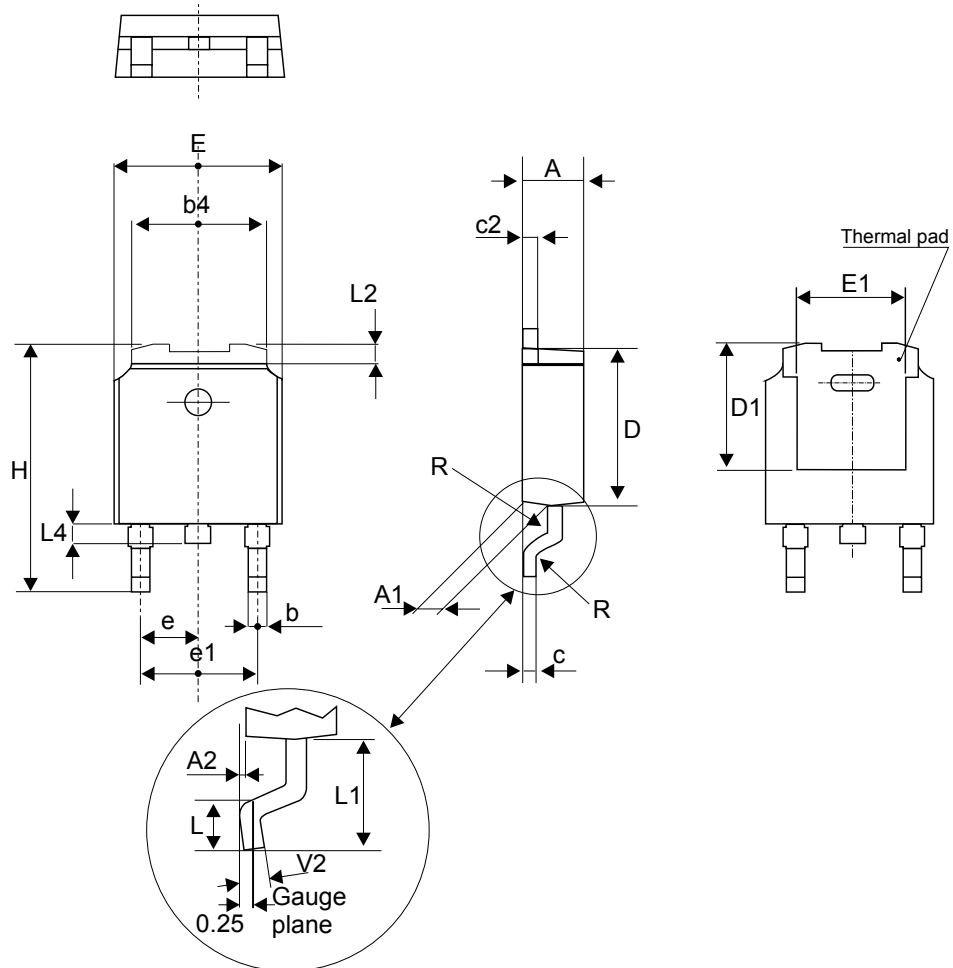

Note: This package drawing may slightly differ from the physical package. However, all the specified dimensions are guaranteed.

Table 7. DPAK package mechanical data

Ref.	Dimensions			
	Millimeters		Inches (for reference only)	
	Min.	Max.	Min.	Max.
A	2.18	2.40	0.085	0.094
A1	0.90	1.10	0.035	0.043
A2	0.03	0.23	0.001	0.009
b	0.64	0.90	0.025	0.035
b4	4.95	5.46	0.194	0.215
c	0.46	0.61	0.018	0.024
c2	0.46	0.60	0.018	0.023
D	5.97	6.22	0.235	0.244
D1	4.95	5.60	0.194	0.220
E	6.35	6.73	0.250	0.265
E1	4.32	5.50	0.170	0.216
e	2.286 typ.		0.090 typ.	
e1	4.40	4.70	0.173	0.185
H	9.35	10.40	0.368	0.409
L	1.0	1.78	0.039	0.070
L2		1.27		0.050
L4	0.60	1.02	0.023	0.040
V2	-8°	+8°	-8°	+8°

Figure 21. DPAK recommended footprint (dimensions in mm)

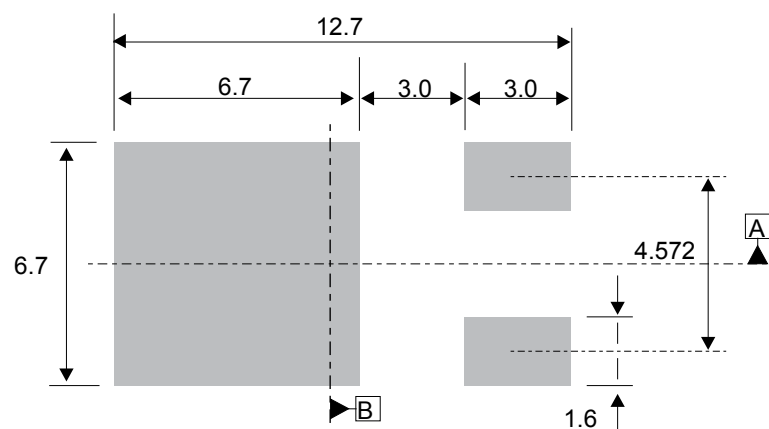

The device must be positioned within $\oplus 0.05$ AB

3 Ordering information

Table 8. Ordering information

Order code	Marking	Package	Weight	Base qty.	Delivery mode
STPS4S200B-TR	S4 200B	D ² PAK	0.032 g	10 000	Tape and reel
STPS4S200S	S42	SMC	0.250 g	2500	Tape and reel
STPS4S200UF	FG42	SMB Flat	0.050 g	5000	Tape and reel
STPS4S200UFN	B42	SMB Flat Notch	0.056 g	5000	Tape and reel

Revision history

Table 9. Document revision history

Date	Version	Changes
17-Oct-2014	1	First release.
26-Aug-2015	2	Added device in SMC package. Updated document accordingly.
15-May-2017	3	Updated DPAK package information and reformatted to current standard.
31-Jan-2019	4	Added Section 2.1 SMB Flat Notch package information .

IMPORTANT NOTICE – PLEASE READ CAREFULLY

STMicroelectronics NV and its subsidiaries (“ST”) reserve the right to make changes, corrections, enhancements, modifications, and improvements to ST products and/or to this document at any time without notice. Purchasers should obtain the latest relevant information on ST products before placing orders. ST products are sold pursuant to ST’s terms and conditions of sale in place at the time of order acknowledgement.

Purchasers are solely responsible for the choice, selection, and use of ST products and ST assumes no liability for application assistance or the design of Purchasers’ products.

No license, express or implied, to any intellectual property right is granted by ST herein.

Resale of ST products with provisions different from the information set forth herein shall void any warranty granted by ST for such product.

ST and the ST logo are trademarks of ST. For additional information about ST trademarks, please refer to www.st.com/trademarks. All other product or service names are the property of their respective owners.

Information in this document supersedes and replaces information previously supplied in any prior versions of this document.

© 2020 STMicroelectronics – All rights reserved