

Deckel/lid

* = Maß durch Formkonizität nach unten verringert.
 Freimaß - Toleranz nach DIN 16901-130/
 Dimension reduced at bottom due to conical form.
 Tolerances to DIN 16901-130.

Zylinderschraube M4 x 37/10
 ähnl. DIN EN ISO 7045/
 cylinder screw M4 x 37/10
 similar to DIN EN ISO 7045

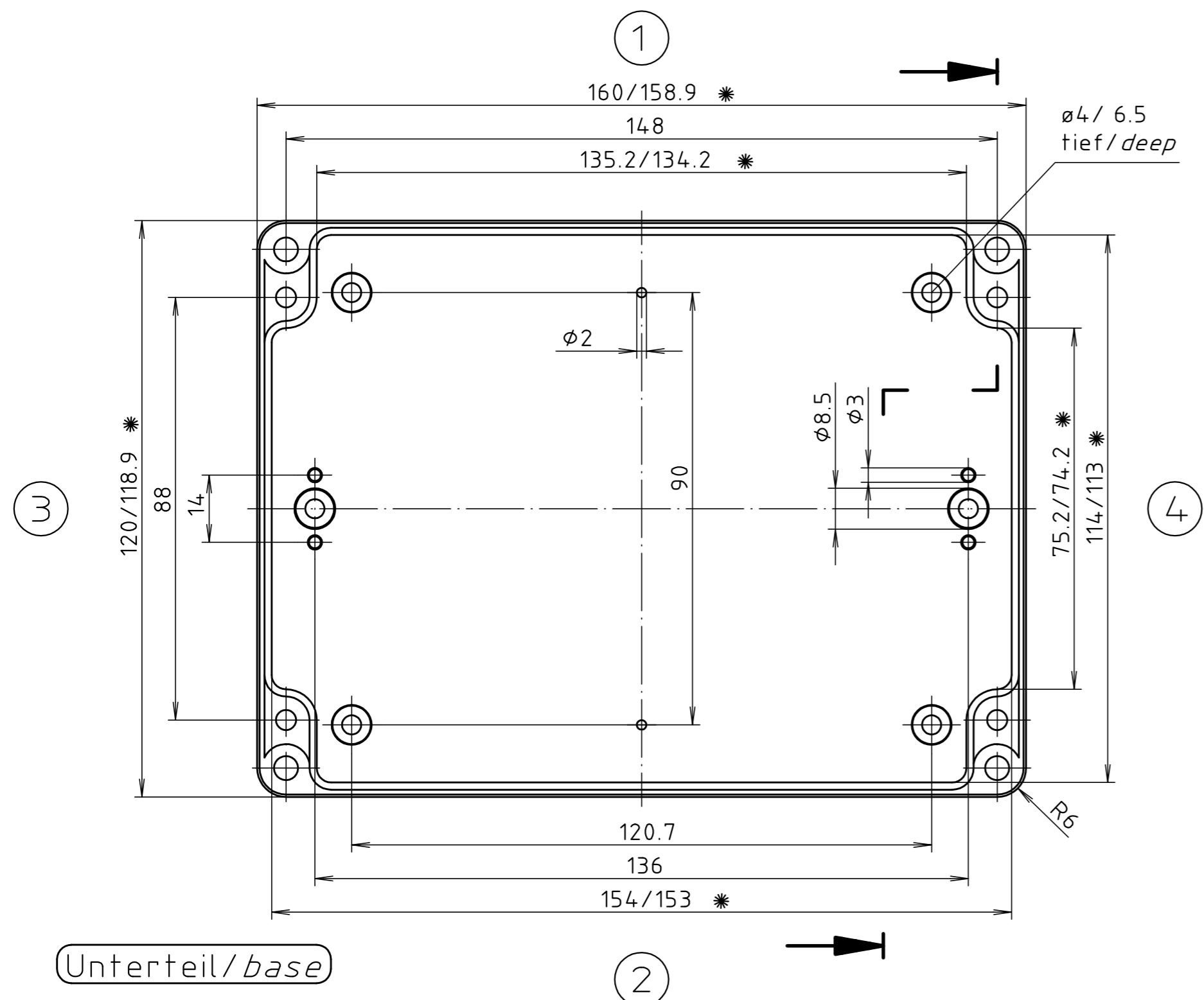

Unterteil/base

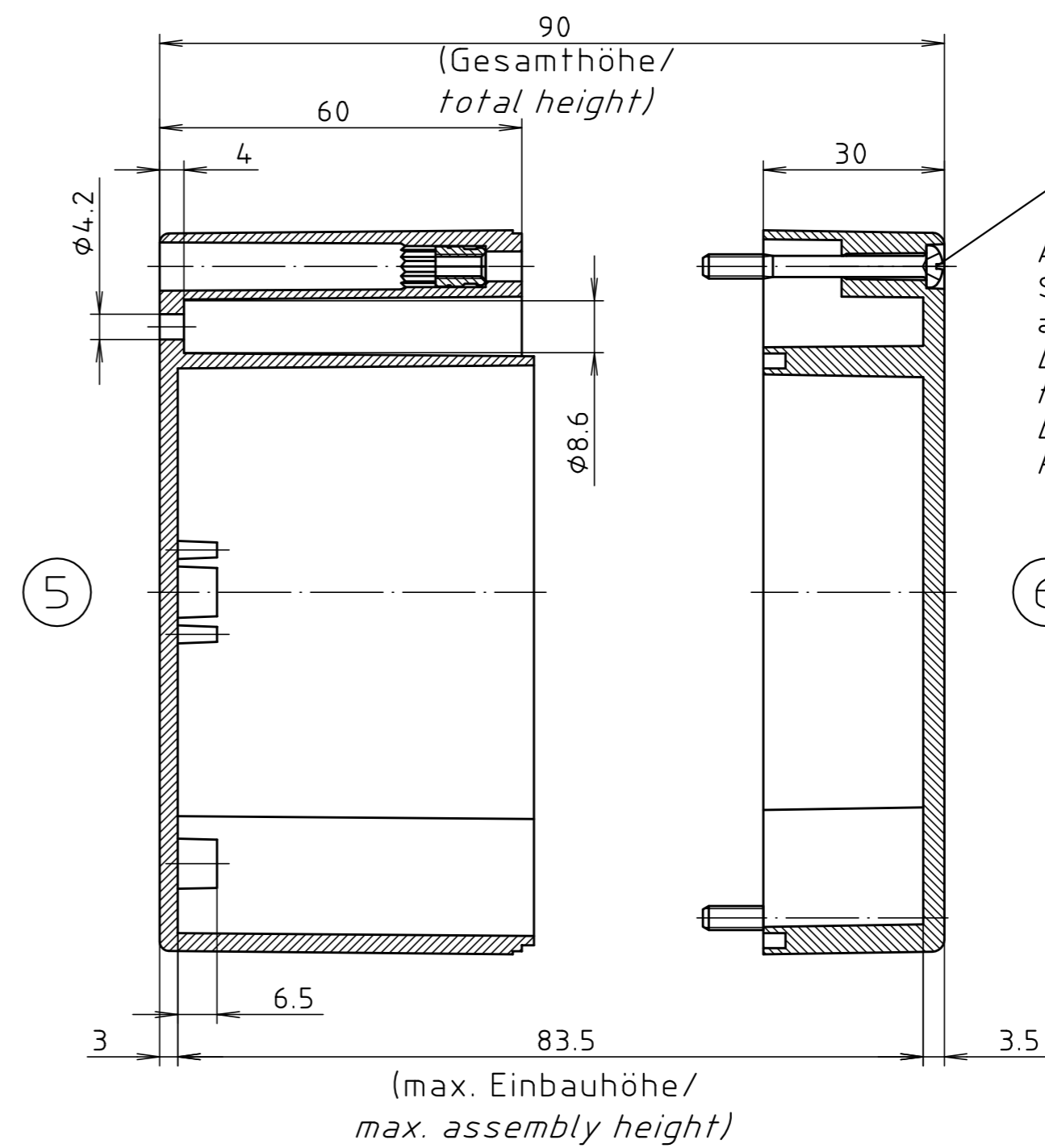

ABS-Gehäuse können durch eine andere
 Schwindung ca. 0,1-0,25% größer sein
 als gezeichnete PC-Gehäuse/
 Due to a different shrinkage rate of
 the plastic material, ABS enclosures can
 be about 0.1 - 0.25% bigger than the
 PC enclosures shown in the drawing.

"Schutzvermerk nach DIN ISO 16016 beachten" "Please pay attention to copyright note DIN ISO 16016"

Maßstab/ Scale: 1:1		
Zeichnungs-Nr. / Drawing-No.: 2K 238.007.03		
Artikel / Article: M/T 238 mit Nocken M/T 238 with bosses Katalogzeichnung / Catalogue drawing		
A.Nr./ Alt-No.: 3601 3499	Datum/ Date: 22.04.02 15.02.2000	
DISK: 2 501 117		
Datum/Date: 25.10.93 OK		

