

MET 1-PHASE CONTROL AND ISOLATION TRANSFORMER

P: 630VA IN: 400VAC+/- 5% OUT: 230VAC

Single-phase - Control and Isolation Transformers
630 VA
Isolation class T 60/B

[Link to Product](#)

Illustration

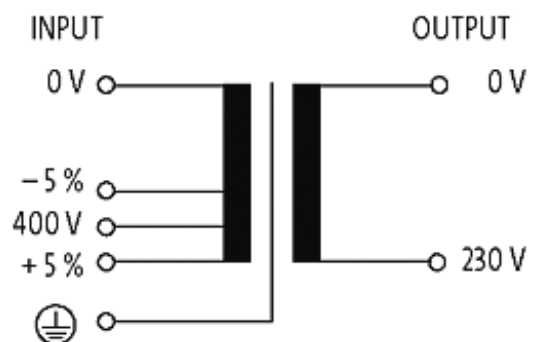
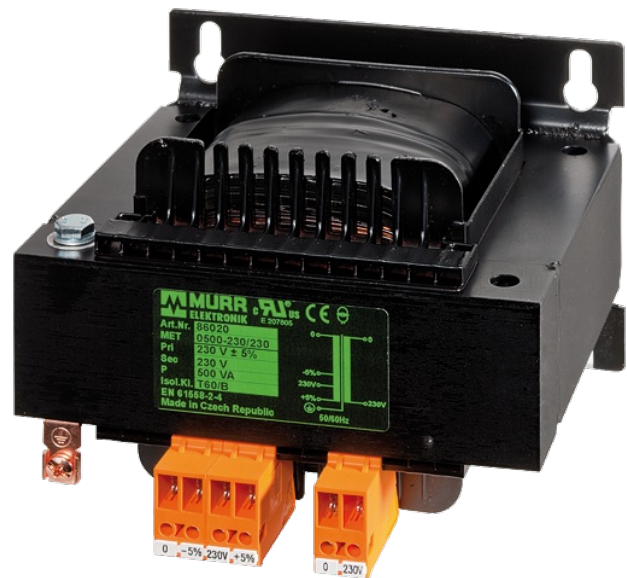

stay connected

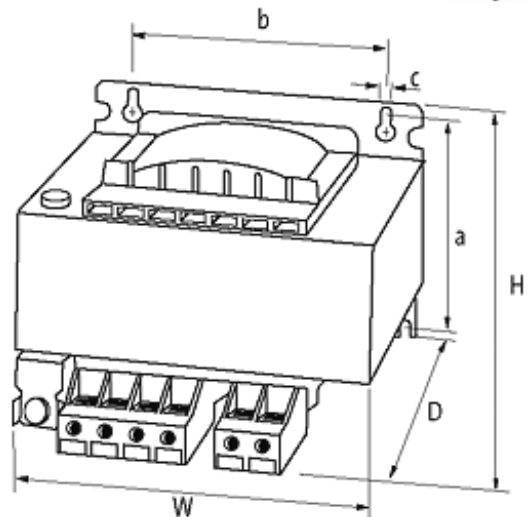

Product may differ from Image

Approvals



Input

Input voltage	400 V AC $\pm 5\%$
Frequency	50...60 Hz
Short-circuit current	68.2 A (400 V AC)
Input current	1.71 A (400 V AC)
Inrush current	27.16 A (400 V AC)

General data

Standards	(EN 61558-1), (EN 61558-2-4), (EN 62041 category 0)
Test isolation voltage	4 kV (prim./sec.)
Dimensions H x W x D	130x150x146 mm
Fixing centers a x b x c	107.5x122x7 mm
Drill hole \varnothing	7x11 mm
Mounting method	Key-hole mounting
Temperature range	-20...+60 °C, no condensation

Output

Output voltage	230 V AC
----------------	----------

Commercial data

country of origin	CZ
customs tariff number	85043180
minimum order quantity	1