





EINSTECKKLASCHE / ADAPTER FUER
SCHRAUBBEFESTIGUNG, FUER GERAETE MIT 1
ODER 2 WECHSLERN





Allgemeine technische Daten:

Produkt-Markenname	SIRIUS
--------------------	--------

Approbationen/ Zertifikate:

allgemeine Produktzulassung	Prüfbescheinigungen	Schiffbau
 CCC	 UL	 ABS
 CSA	spezielle Prüfbescheinigungen <u>n</u>	
		

Schiffbau	sonstiges
 GL	Bestätigungen
 LRS	
 RMRS	

Weitere Informationen

Information- and Downloadcenter (Kataloge, Broschüren,...)
<http://www.siemens.de/industrial-controls/catalogs>

Industry Mall (Online-Bestellsystem)
<http://www.siemens.com/industrymall>

CAX-Online-Generator
<http://support.automation.siemens.com/WW/CAXorder/default.aspx?lang=de&mlfb=3RP1903>

Service&Support (Handbücher, Betriebsanleitungen, Zertifikate, Kennlinien, FAQs,...)
<https://support.industry.siemens.com/cs/ww/de/ps/3RP1903>

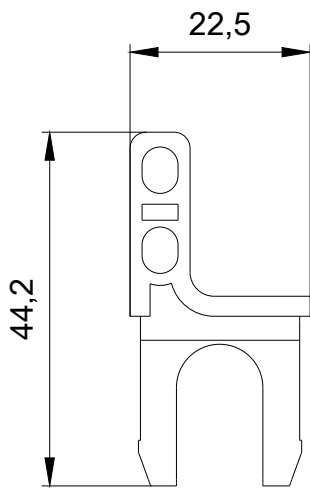

letzte Änderung:

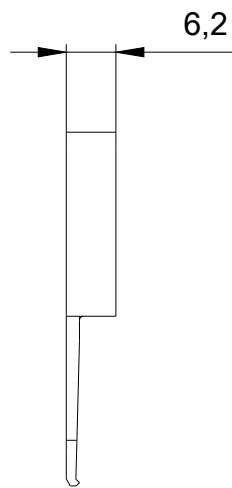

23.02.2015