

1A, 20V - 40V Schottky Barrier Rectifiers

FEATURES

- Low forward voltage drop
- Guardring for overvoltage protection
- High surge current capability
- Compliant to RoHS Directive 2011/65/EU and in accordance to WEEE 2002/96/EC
- Halogen-free according to IEC 61249-2-21

MECHANICAL DATA

Case: DO-204AL (DO-41)

Molding compound, UL flammability classification rating 94V-0

Part no. with suffix "H" means AEC-Q101 qualified

Packing code with suffix "G" means green compound (halogen-free)

Terminal: Pure tin plated leads, solderable per JESD22-B102

Meet JESD 201 class 2 whisker test

Polarity: Indicated by cathode band

Weight: 0.33 gram (approximately)



DO-204AL (DO-41)



MAXIMUM RATINGS AND ELECTRICAL CHARACTERISTICS (T _A =25°C unless otherwise noted)					
PARAMETER	SYMBOL	1N5817	1N5818	1N5819	UNIT
Maximum repetitive peak reverse voltage	V _{RRM}	20	30	40	V
Maximum RMS voltage	V _{RMS}	14	21	28	V
Maximum DC blocking voltage	V _{DC}	20	30	40	V
Maximum average forward rectified current	I _{F(AV)}	1			A
Peak forward surge current, 8.3 ms single half sine-wave superimposed on rated load	I _{FSM}	30			A
Maximum instantaneous forward voltage (Note 1) @ 1 A	V _F	0.45	0.55	0.60	V
Maximum reverse current @ rated V _R	I _R	1 10			mA
		T _J =25°C T _J =100°C			
Typical junction capacitance (Note 2)	C _J	55			pF
Voltage rate of change (Rated V _R)	dV/dt	10000			V/μs
Typical thermal resistance	R _{θJC} R _{θJA}	45 100			°C/W
Operating junction temperature range	T _J	- 55 to +125			°C
Storage temperature range	T _{STG}	- 55 to +125			°C

Note 1: Pulse test with PW=300 μs, 1% duty cycle

Note 2: Measure at 1 MHz and Applied Reverse Voltage of 4.0 V D.C.

ORDERING INFORMATION					
PART NO.	PART NO. SUFFIX	PACKING CODE	PACKING CODE SUFFIX (*)	PACKAGE	PACKING
1N581x (Note 1)	H	A0	G	DO-41	3,000 / Ammo box (52mm taping)
		R0		DO-41	5,000 / 13" Paper reel
		R1		DO-41	5,000 / 13" Paper reel (Reverse)
		B0		DO-41	1,000 / Bulk packing

Note 1: "x" defines voltage from 20V (1N5817) to 40V (1N5819)

*: Optional available

EXAMPLE					
PREFERRED P/N	PART NO.	PART NO. SUFFIX	PACKING CODE	PACKING CODE SUFFIX	DESCRIPTION
1N5817HA0G	1N5817	H	A0	G	AEC-Q101 qualified Green compound

RATINGS AND CHARACTERISTICS CURVES

(T_A=25°C unless otherwise noted)

FIG. 1 MAXIMUM FORWARD CURRENT DERATING CURVE

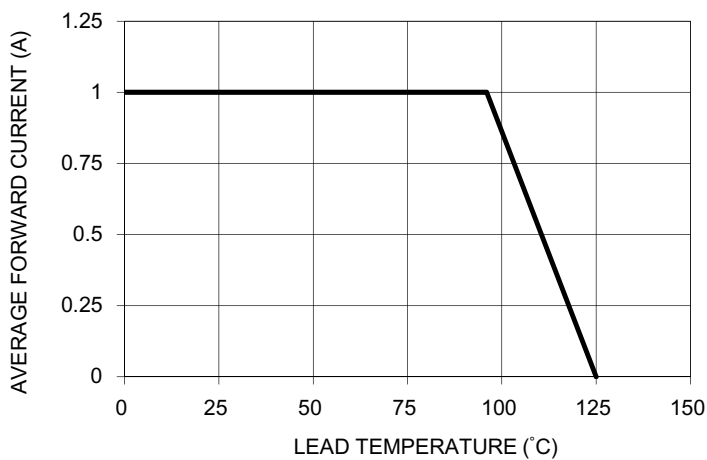

FIG. 2 MAXIMUM NON-REPETITIVE FORWARD SURGE CURRENT

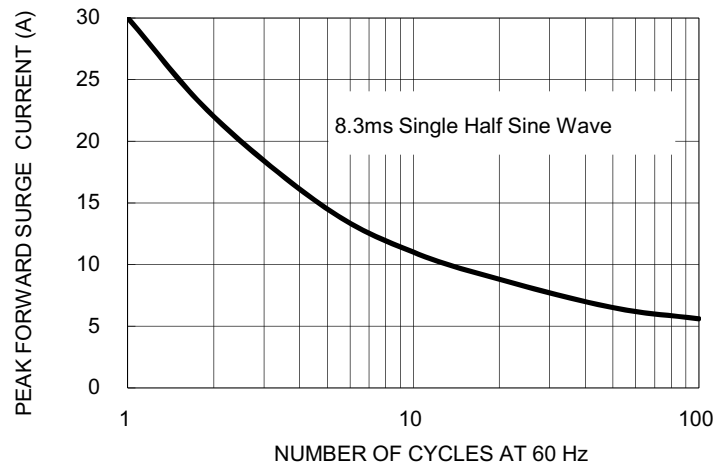

FIG. 3 TYPICAL FORWARD CHARACTERISTICS

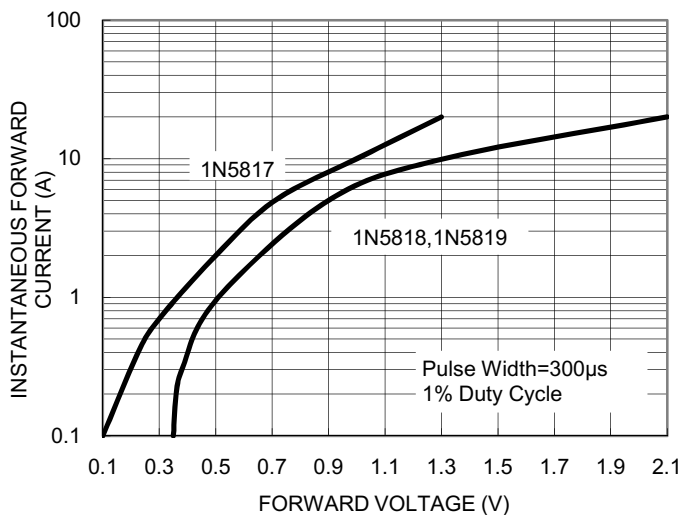

FIG. 4 TYPICAL REVERSE LEAKAGE CHARACTERISTICS

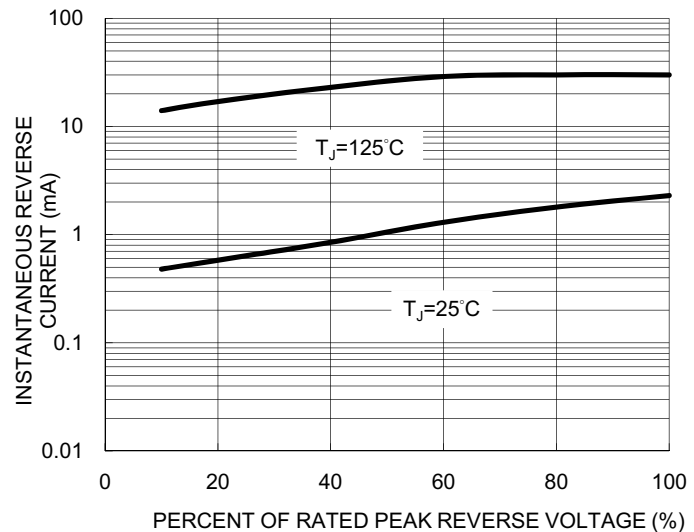

FIG. 5 TYPICAL JUNCTION CAPACITANCE

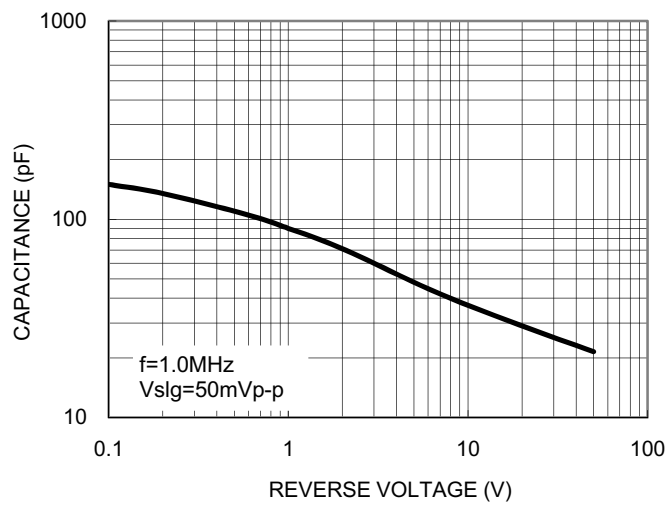
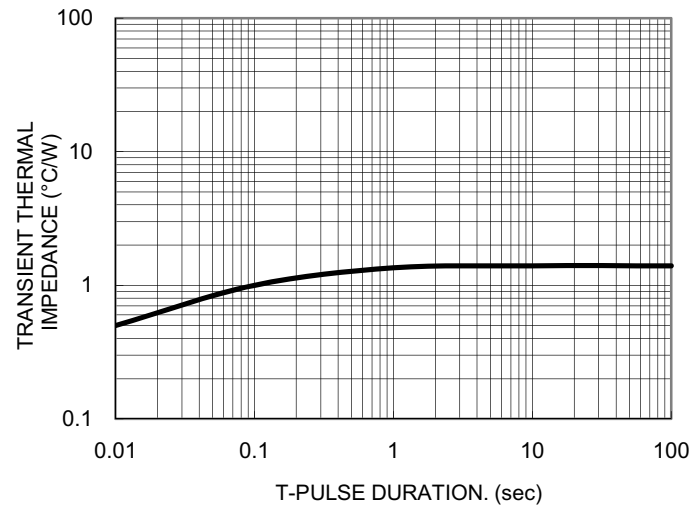
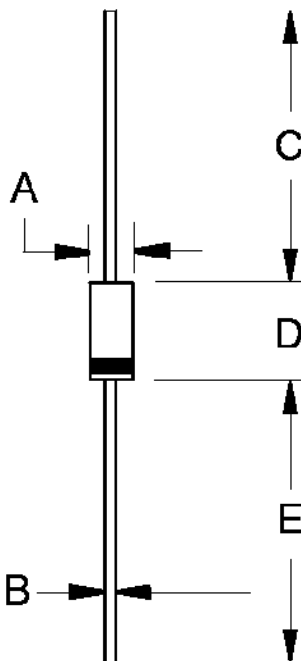

FIG. 6 TYPICAL TRANSIENT THERMAL CHARACTERISTICS



DIMENSIONS

DO-204AL (DO-41)



DIM.	Unit (mm)		Unit (inch)	
	Min	Max	Min	Max
A	2.00	2.70	0.079	0.106
B	0.71	0.86	0.028	0.034
C	25.40	-	1.000	-
D	4.20	5.20	0.165	0.205
E	25.40	-	1.000	-

MARKING DIAGRAM



- P/N = Specific Device Code
- G = Green Compound
- YWW = Date Code
- F = Factory Code

Notice

Specifications of the products displayed herein are subject to change without notice. TSC or anyone on its behalf, assumes no responsibility or liability for any errors or inaccuracies.

Information contained herein is intended to provide a product description only. No license, express or implied, to any intellectual property rights is granted by this document. Except as provided in TSC's terms and conditions of sale for such products, TSC assumes no liability whatsoever, and disclaims any express or implied warranty, relating to sale and/or use of TSC products including liability or warranties relating to fitness for a particular purpose, merchantability, or infringement of any patent, copyright, or other intellectual property right.

The products shown herein are not designed for use in medical, life-saving, or life-sustaining applications. Customers using or selling these products for use in such applications do so at their own risk and agree to fully indemnify TSC for any damages resulting from such improper use or sale.