

Montagescheiben

Mounting pads

Entretoises

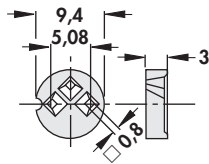

TO 5
MS 53 3

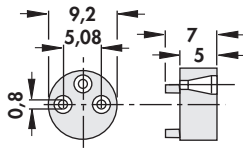

TO 5
MS 53 7

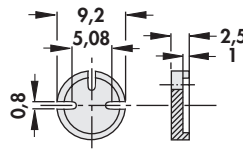

TO 5
MS 53 25

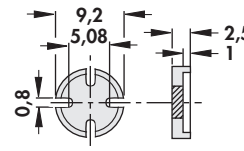

TO 5
MS 54 25

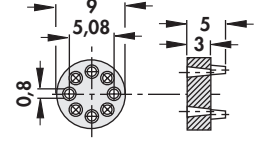

TO 5-8 p.
MS 58 5

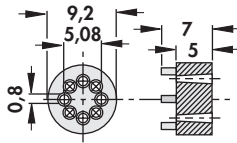

TO 5-8 p.
MS 58 7

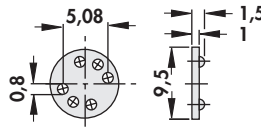

TO 5-6 p.
MS 56 15

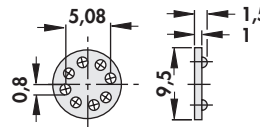

TO 5-8 p.
MS 58 15

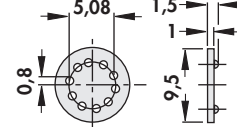

TO 5-10 p.
MS 510 15

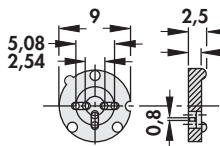

TO 5/18
MS 3518 25

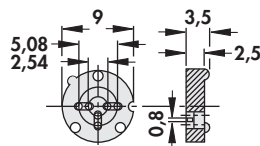

TO 5/18
MS 3518 35

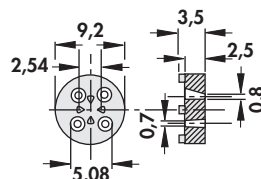

TO 5/18
MS 34 518

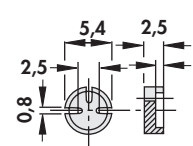

TO 18
MS 183 25

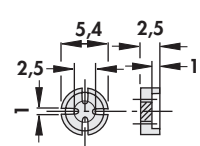

TO 18
MS 184 25

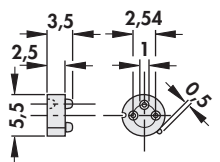

TO 18
MS 183 35

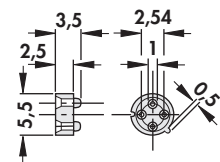

TO 18
MS 184 35

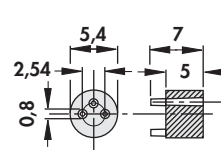

TO 18
MS 183 7

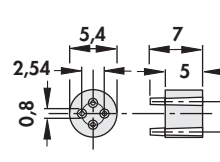

TO 18
MS 184 7

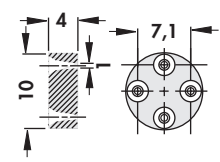

TO 8
MS 84 4

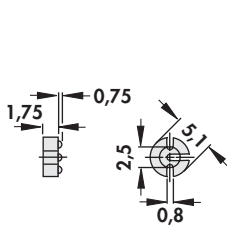

TO 92
MS 923 25

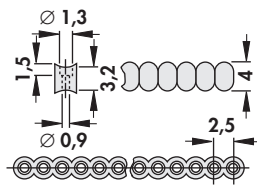

axiale Bauelemente
axial components
composants axiaux

MS 4016

max. 16 pol.

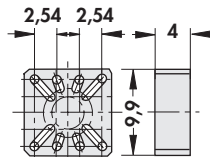

TO 5
US 58 4

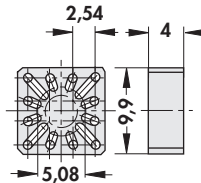

TO 5
US 512 4

Umsetzscheiben

Die US-Scheiben setzen den TO 5-Teilkreis auf 2,54 mm Raster um.

Mounting pads

The US-pads convert the TO 5 pin circle to a pitch of .1".

Entretoises

Les rondelles US convertissent le cercle d'un TO 5 en grille de 2,54 mm.

Technische Daten:

Material: glasfaserverstärktes Polyamid
Hitzebeständigkeit: 145°C

Brennbarkeitsklasse: UL 94 V-0 ($\frac{1}{8} \geq 3$ mm)
UL 94 V-1

Technical Data:

material: Polyamide glassfibre filled
heat resistant: 145°C

flammability: UL 94 V-0 ($\frac{1}{8} \geq 3$ mm)
UL 94 V-1

Caractéristiques techniques:

matière: Polyamid renforcé de fibre de verre
résistant thermique jusqu'à 145°C

inflammabilité: UL 94 V-0 ($\frac{1}{8} \geq 3$ mm)
UL 94 V-1

Montagescheiben für Leistungstransistoren

Mounting pads for power transistors

Entretoises pour transistors de puissance

- für TO 220, TO 219, TO 202 und ähnliche
- für vertikale und horizontale Montage
- ebenso geeignet als Halterung für abgewinkelte Anschlüsse

- for TO 220, TO 219, TO 202 and similar transistors
- for vertical and horizontal mounting
- also suitable as mounting bracket for angled connections

- pour TO 220, TO 219, TO 202 et similaires
- pour montage verticale et horizontale
- également convenable comme fixation pour connexions coudées

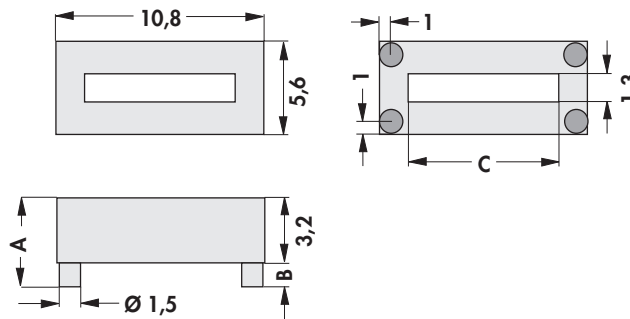
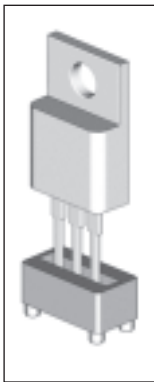

Art. Nr. Art. No. Art. n°	Farbe Colour Couleur	Maße/Dimensions [mm]		
		A	B	C
MLW 32	weiß white blanche	3,2	-	7,1
MLW 38		3,8	0,64	7,1
MLW 44		4,4	1,3	7,1
MLW 51		5,1	1,9	7,1
MLB 32	schwarz black noire	3,2	-	6,5
MLB 38		3,8	0,64	6,5
MLB 44		4,4	1,3	6,5
MLB 51		5,1	1,9	6,5

Montagescheiben für rechteckige Leuchtdioden

Mounts for rectangular LED's

Supports pour diodes électroluminescentes rectangulaires

- für LED 2x4 mm oder 2x5 mm
- symmetrische Ausführung für einfache Bestückung
- selbsthaltend

- for use with 2x4 mm or 2x5 mm LED's
- symmetrical for ease of assembly
- self retaining

- pour DEL 2x4 mm ou 2x5 mm
- version symétrique pour équipement facile
- autotenant

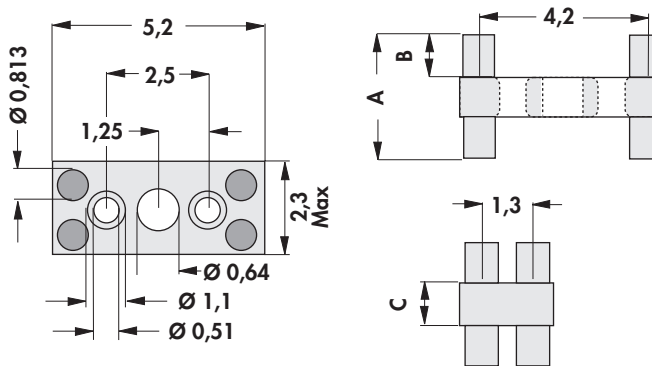
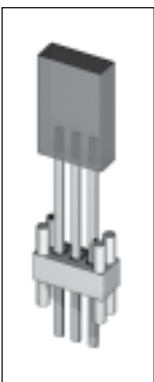

Art. Nr. Art. No. Art. n°	Maße/Dimensions [mm]		
	A	B	C
MRL 20	2,0	0,5	1,0
MRL 30	3,0	1,0	1,0
MRL 41	4,1	1,5	1,0
MRL 51	5,1	2,0	1,0
MRL 61	6,1	1,1	3,8
MRL 71	7,1	1,7	3,8
MRL 81	8,1	2,2	3,8
MRL 89	8,9	2,5	3,8

Technische Daten:

Material: Nylon, weiß
Temperaturbereich: -40°C...+120°C

Brennbarkeitsklasse: UL 94:V-2

Technical Data:

Material: Nylon, white
Temperature range: -40°C...+120°C

Flammability: UL 94:V-2

Caractéristiques techniques:

Matière: Nylon, blanche
Gamme de températures: -40°C...+120°C
Inflammabilité: UL 94:V-2

Montagescheiben für diskrete Bauelemente
Isoliermontageteile für Leistungstransistoren
Leuchtdiodenhalter

Mounts for discrete components
Insulating mounting parts for power transistors
LED holders

Entretoises pour composants discrets
Éléments de montage isolants pour transistors de puissance
Supports LED

→ E 25
→ E 24
→ L 5 - 15

Montagescheiben für diskrete Bauelemente

Mounts for discrete components

Entretoises pour composants discrets

Geeignet für diverse Einzelbauteile wie z. B. Widerstände, Kondensatoren etc.

Suitable for various components e.g. resistors, capacitors etc.

Convenables pour divers composants comme p. ex. résistances, condensateurs etc.

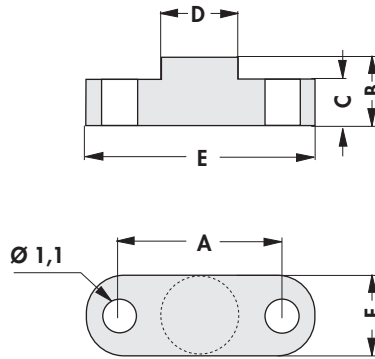

Art. Nr. Art. No. Art. n°	Maße/Dimensions [mm]					
	A	B	C	D	E	F
MD A 04	2,5	1,1	0,55	1,3	4,6	2,3
MD A 06	3,8	1,1	0,55	2,3	6,9	3,2
MD A 07	5,1	1,1	0,55	2,3	7,4	2,3
MD A 08	6,4	1,1	0,66	2,3	8,6	2,3
MD A 09	7,6	1,1	0,66	3,6	9,9	2,3
MD A 12	10,2	1,1	0,76	4,8	12,4	2,3

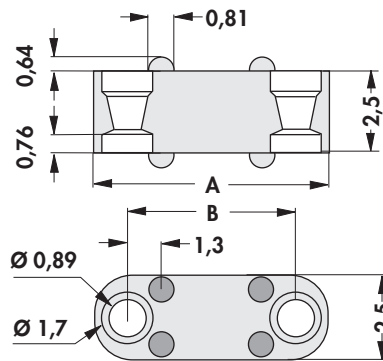
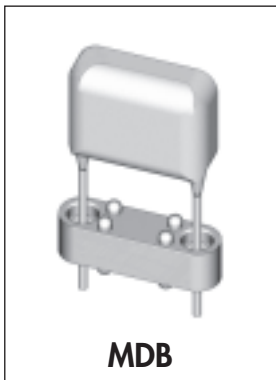

Art. Nr. Art. No. Art. n°	Maße/Dimensions [mm]	
	A	B
MD B 07	7,6	5,1
MD B 08	8,9	6,4
MD B 10	10,2	7,6
MD B 11	11,4	8,9
MD B 12	12,7	10,2
MD B 15	15,2	12,7

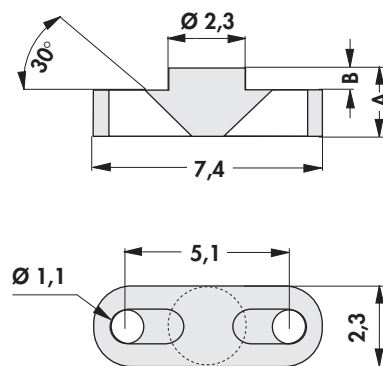
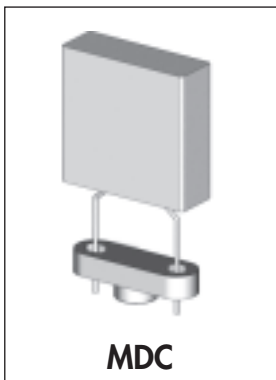

Art. Nr. Art. No. Art. n°	Maße/Dimensions [mm]	
	A	B
MD C 13	1,3	-
MD C 18	1,8	0,56
MD C 22	2,2	0,89

Technische Daten:

Material: Polyamid 6 (Nylon), UL94:V-2
Temperaturbereich: -30 °C ... +110 °C

Technical Data:

Material: Polyamide 6 (Nylon), UL94:V-2
Temperature rating: -30 °C ... +110 °C

Caractéristiques techniques:

Matière: Polyamide 6 (Nylon), UL94:V-2
Gamme de température: -30 °C ... +110 °C