



Be sure. **testo**



# Made to make it easy.

Our compact HVAC measuring instruments deliver precise results wherever you need them – fast, flexible, user-friendly and connected to your smartphone. Measuring couldn't be easier.

[www.testo.com](http://www.testo.com)

# The new ones from Testo:

## 11 measuring instruments.

## 9 measurement parameters.

## 1 App.

# Endless possibilities.

Switch on, measure and know more immediately: Our new digital HVAC measuring instruments give you precise readings - easily and quickly. That is our promise to you.

Because we know that things have to move fast in your job and that you need reliable measurement results immediately in order to be able to carry on.

But we also know that good measurement technology must also be smart - which is why our compact newcomers and your smartphone are true partners thanks to the testo Smart App.

**What are you waiting for? Make it easy for yourself.**



Vane anemometer  
**testo 417**  
m/s, m<sup>3</sup>/h, °C

Vane anemometer  
**testo 416**  
m/s, m<sup>3</sup>/h

Hot wire anemometer  
**testo 425**  
m/s, m<sup>3</sup>/h, °C

CO<sub>2</sub> measuring instrument  
**testo 535**  
CO<sub>2</sub>

Lux meter  
**testo 545**  
Lux

Digital thermohygrometer  
**testo 625**  
°C, %RH, °Cwb, °Ctp

Pressure measurement

Temperature



Differential pressure measuring instrument  
**testo 512-1**  
hPa/mbar, m/s, m<sup>3</sup>/h

Differential pressure measuring instrument  
**testo 512-2**  
hPa/mbar

Differential temperature measuring instrument  
**testo 922**  
°C

Temperature measuring instrument  
**testo 925**  
°C

NTC+ PT100 Temperature measuring instrument  
**testo 110**  
°C

## Compact precision for your jobs.

Testo's new digital HVAC measuring instruments are always there when you need accurate readings fast.

Little time, endless to-do lists and complex tasks: These are the moments when the new compact measuring instruments from Testo are reliably at your side.

**The right instrument for every relevant measurement parameter:** Simply turn it on and right away you have exactly the reading you need to make the right decisions. In all important applications - **fast, simple and precise.**

And with the **testo Smart App**, you not only have the most important measurement menus with you at all times - documentation and measured value storage are possible at any time with your smart assistant (see App info from p. 12).



# Easy

- Compact design: **Quickly to hand, quickly stowed away.**
- Robust workmanship: **When the going gets tough.**
- Intuitive operation: **High-tech reduced to the essentials.**
- Print reports on site: **Everything in black on white.**
- **testo Smart App:** **Configure, save, document measurements and much more (see p. 12).**



Each instrument comes in a practical, compact and robust **testo Smart Case**



# Fast

- Measurement results immediately: **With one look, everything is clear.**
- Configuration with the testo Smart App: **Make settings with just a few clicks.**
- Automatic volume flow calculation: **The duct diameter is enough.**
- Two displays show more than one: **Show your customers measurement curves on a smartphone. In real time.**

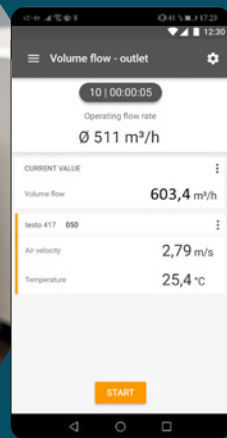

# Precise

- Digital probes proven in practice: **For long-term stable, reproducible and accurate measurement results.**
- Helpful measurement menus: **Single-point and time curve measurement in every instrument.**
- Complex measurements, compactly simplified: **For example, very easy measurement, adjustment and documentation of living space ventilation.**
- Documentation with the testo Smart App: **Completely without paperwork.**





## Air conditioning and ventilation systems easily under control.

Compact flow velocity and volume flow measurement.

To ensure that people enjoy spending time indoors, air conditioning and ventilation systems are a crucial factor for modern buildings.

Accordingly, it is important to ensure with the appropriate measurement technology that sufficient fresh air is supplied to the rooms and that stale air is discharged. And this with the best possible efficiency, for all VAC units.

With the new flow velocity measuring instruments from Testo, you can perform these tasks quickly, easily, precisely and with smart App support: **In the duct, at the outlet** and when **adjusting the balanced residential ventilation**.

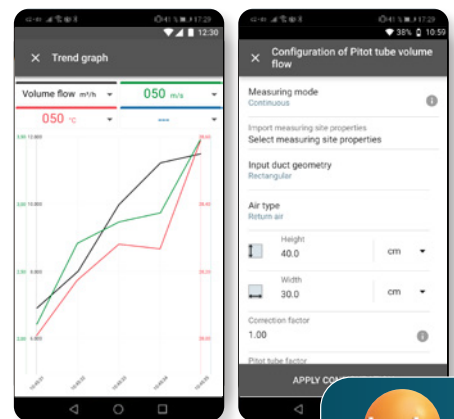

### This is how the testo Smart App supports you

- Configure your measuring instrument
- Display graphical measured value curve
- Save measurement data
- Customer and measuring location management
- Documentation of your work
- E-mail dispatch of the report



**Digital 100 mm vane anemometer testo 417**

Simple, fast and precise measurement of flow, volume flow and temperature at air inlets and outlets

- Efficient regulation of balanced residential ventilation and fast documentation with the testo Smart App
- Fast in-app configuration, graph history, second screen and measurement data memory in the testo Smart App
- Timed and multi-point mean calculation
- Durability through compact design with robust housing

Order no. 0563 0417

**testo 417 kit 1**

Incl. funnel kit for plate outlets and ventilation grilles.

Order no. 0563 1417



**testo 417 kit 2**

As kit 1, plus flow straightener for swirl vents.

Order no. 0563 2417



**Digital 16 mm vane anemometer testo 416**

Simple, fast and precise flow measurement & volume flow calculation in the ventilation duct

- More flexibility for duct measurements with the cable-connected telescopic probe (maximum length 850 mm)
- Fast in-app configuration, graph history, second screen and measurement data memory in the testo Smart App
- Timed and multi-point mean calculation
- Durability through compact design with robust housing

Order no. 0563 0416

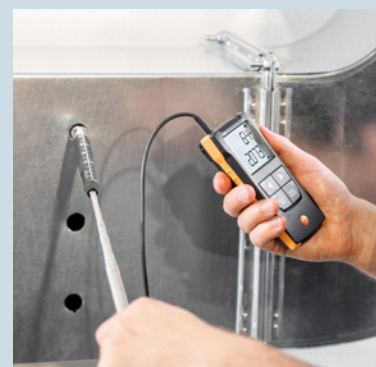

**Digital hot wire anemometer testo 425**

Simple, fast and precise flow and temperature measurement plus volume flow calculation in the ventilation duct

- More flexibility for duct measurements with the cable-connected telescopic probe (maximum length 820 mm)
- Fast in-app configuration, graph history, second screen and measurement data memory in the testo Smart App
- Timed and multi-point mean calculation
- Durability through compact design with robust housing

Order no. 0563 0425





## Comfort **easily under control.**

For a more comfortable indoor climate.

Living, working or leisure: We spend almost 90% of our time indoors every day!

The topics of **indoor air quality and comfort** could therefore hardly be more important for well-being and health.

With the new compact measuring instruments from Testo, you have CO<sub>2</sub>, illuminance, temperature and air humidity quickly, easily and precisely in view - and thus ensure comfort and a healthy climate indoors.



### Digital CO<sub>2</sub> measuring instrument testo 535

- Simple, fast and precise measurement of CO<sub>2</sub> concentration
- Audible alarm sounds if a limit value is exceeded
- Fast in-app configuration, graph history, second screen and measurement data memory in the testo Smart App
- High reproducibility of measurement results due to long-term stable infrared sensor technology
- Timed and multi-point mean calculation

Order no. 0563 0535





### This is how the testo Smart App supports you

- Configure your measuring instrument
- Display graphical measured value curve
- Save measurement data
- Customer and measuring location management
- Documentation of your work
- E-mail dispatch of the report



### Digital lux meter testo 545

Simple, fast and precise measurement of illuminance (lux) according to the V-lambda curve for all common light sources

- Wide range of applications due to LED compatibility (except single-colour blue LED)
- Fast in-app configuration, graph history, second screen and measurement data memory in the testo Smart App
- Audible alarm sounds if a limit value is exceeded
- Timed and multi-point mean calculation

Order no. 0563 1545

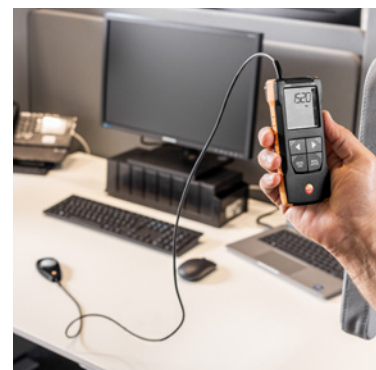

### Digital thermohygrometer testo 625

Simple, fast and precise measurement of air temperature and relative humidity

- Calculation of dewpoint and wet bulb temperature
- Fast in-app configuration, graph history, second screen and measurement data memory in the testo Smart App
- Audible alarm sounds if a limit value is exceeded
- Timed and multi-point mean calculation

Order no. 0563 1625



# Pressure measurement **easily under control.**

## Compact pressure measurement.

The new compact measuring instruments from Testo are also reliably at your side for two of the most important measurements on heating systems. For fast measurement results when it counts.

With the differential pressure measuring instrument testo 512, you can check the gas pressure on burners quickly and precisely by measuring gas flow pressure and static gas pressure - indispensable for maintenance work on **heating systems.**

testo 512 is also your reliable partner for **general pressure measurement, checking filters** and **Pitot tube measurement**.

And with the differential temperature measuring instrument testo 922, (p. 11), you have the supply/return temperature on heating circuit distributors under control.



**Pro tip:**  
Ideal for measuring gas flow/static gas pressure.

### Digital differential pressure measuring instrument testo 512-1

Simple, fast and precise differential pressure measurement (0 to 200 hPa) for checking filters and for Pitot tube measurement in the air duct

- Reliable measurement results due to position-independent differential pressure sensor with high accuracy
- Fast in-app configuration, graph history, second screen and measurement data memory in the testo Smart App
- Volume flow calculation in measuring instrument and App
- Audible alarm sounds if a limit value is exceeded

Order no. 0563 1512



**Pro tip:**  
Ideal for measuring high pressures.

### Digital differential pressure measuring instrument testo 512-2

Simple, fast and precise differential pressure measurement (0 to 2,000 hPa)

- Fast in-app configuration, graph history, second screen and measurement data memory in the testo Smart App
- Audible alarm sounds if a limit value is exceeded
- Timed and multi-point mean calculation
- Durability through compact design with robust housing

Order no. 0563 2512

### This is how the testo Smart App supports you

- Configure your measuring instrument
- Display graphical measured value curve
- Save measurement data
- Customer and measuring location management
- Documentation of your work
- E-mail dispatch of the report





**Pro tip:**  
Ideal for measuring flow/  
return temperature.

## Temperatures **easily under control.**

Measure the most important measurement value compactly.

### Digital differential temperature measuring instrument **testo 922**

Easy, fast and precise differential temperature measurement with dual thermocouple Type K probe (2 TC Type K probes included)

- Fast in-app configuration, graph history, second screen and measurement data memory in the testo Smart App
- Wide range of applications due to large measuring range from -50 °C to 1000 °C
- Large sensor selection optional and compatible with commercially available TC Type K sensors
- Audible alarm sounds if a limit value is exceeded

Order no. 0563 0922



### Digital temperature measuring instrument **testo 925**

Easy, fast and precise temperature measurement with thermocouple Type K probe (1 TC Type K probe included)

- Fast in-app configuration, graph history, second screen and measurement data memory in the testo Smart App
- Wide range of applications due to large measuring range from -50 °C to 1000 °C
- Large sensor selection optional and compatible with commercially available TC Type K sensors
- Audible alarm sounds if a limit value is exceeded

Order no. 0563 0925



## Temperature measurement in laboratory and food environment

## Temperatures in the laboratory and food environment **easily under control.**

Particularly precise, even at low temperatures.

### Digital temperature measuring instrument **testo 110**

Simple, fast and particularly precise temperature measurement with NTC or Pt100 sensor (optionally available)

- Fast in-app configuration, graph history, second screen and measurement data memory in the testo Smart App
- HACCP-compliant, certified according to EN 13485 for use in the food sector
- High-precision measurement results and high system accuracy with digital Pt100 sensors (calibration without measuring instrument)
- Audible alarm sounds if a limit value is exceeded

Order no. 0563 0110



# One App for everything: **That's smart!**

The testo Smart App will become your indispensable companion.

What's special about the new ones from Testo: You can configure and use them according to your needs. Just measure and nothing more? Not an issue at all. But you have other settings in mind, you would like to save the measured values, and documentation is also important?

Easy to use - with the testo Smart App. Get the most out of your new measuring instrument with the free App. And of course, the App and the measuring instrument simply connect automatically.

# Easy

- Intuitive measurement menus
- Quick configuration
- Uncomplicated documentation

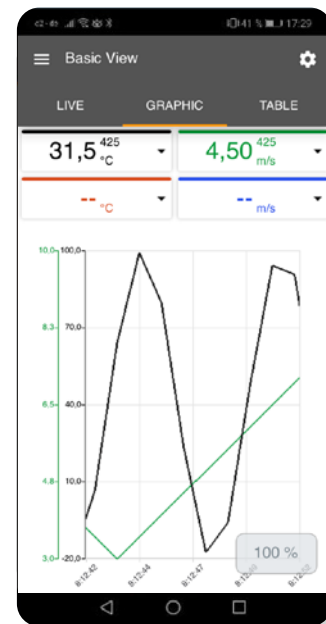
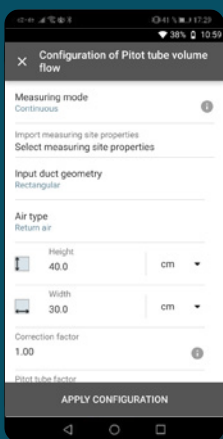

# Fast

- To the measurement in just a few clicks
- All measurement values at a glance
- Graphic or tabular curve display

# Efficient

- Storage of measurement and customer data
- Easy report generation and dispatch by e-mail
- Second display

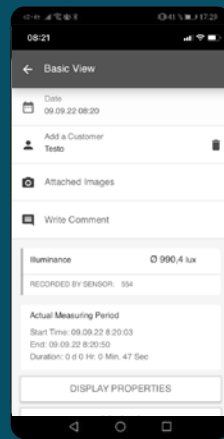
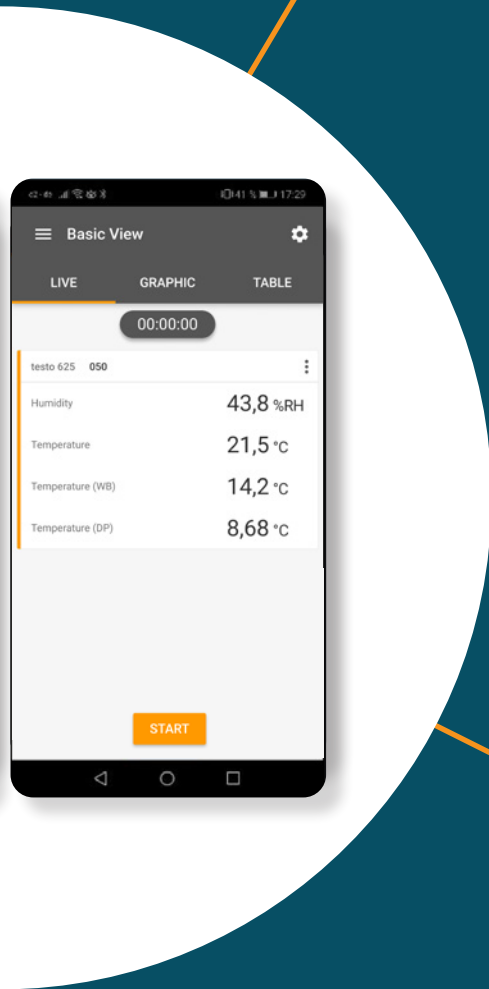





# Clever



- Data exchange with PC software testo DataControl
- Continuous updates and extensions
- Free download, free use





# Do you want to be absolutely sure? **Good.**

All technical data at a glance.

Air conditioning and ventilation systems					
Product	testo 416	testo 417	testo 417 kit 1	testo 417 kit 2	testo 425
Description	16 mm vane anemometer with App connection, fixed telescope (max. 850 mm), incl. transport bag and calibration protocol	100 mm vane anemometer with App connection, incl. transport bag and calibration protocol	100 mm vane anemometer with App connection, incl. measuring funnel for plate outlets, measuring funnel for ventilation grilles, transport bag and calibration protocol	100 mm vane anemometer with App connection incl. measuring funnel for plate outlets, measuring funnel for ventilation grilles, flow straightener, transport bag and calibration protocol	Thermal hot wire anemometer with App connection, fixed telescope (max. 820 mm), incl. transport bag and calibration protocol
Measurement parameter	m/s, fpm, m <sup>3</sup> /h, cfm, l/s	m/s, fpm, °C, °F, m <sup>3</sup> /h, cfm, l/s			m/s, fpm, °C, °F, m <sup>3</sup> /h, cfm, l/s
Measuring range	0.6 to 40 m/s	0.3 to 20 m/s 0 to +50 °C			0 to 30 m/s -20 to +70 °C
Accuracy	±(0.2 m/s + 1% of reading)	±(0.1 m/s + 1.5% of m.v.) ±0.5 °C			±(0.03 m/s + 4% of m.v.) (0 to 20 m/s) ±(0.5 m/s + 5% of m.v.) (20.01 to 30 m/s) ±0.5 °C
Solution	0.1 m/s	0.01 m/s 0.1 m <sup>3</sup> /h (0 to +99.9 m <sup>3</sup> /h) 1 °C /h (rem. measuring range) 0.1 °C			0.01 m/s 0.1 °C
Classification	IP40 (probe: IP20)	IP40 (probe: IP20)			IP40 (probe: IP20)
Battery (incl.)	3 x AA	3 x AA			3 x AA
Battery life (h)	60	50			35
Connection testo Smart App	✔	✔			✔
Order no.	0563 0416	0563 0417	0563 1417	0563 2417	0563 0425

Pressure measurement		
Product	testo 512-1	testo 512-2
Description	Differential pressure measuring instrument with App connection, measuring range 0 to 200 hPa, audible alarm, incl. transport bag and calibration protocol	Differential pressure measuring instrument with App connection, measuring range 0 to 2,000 hPa, audible alarm, incl. transport bag and calibration protocol
Measurement parameter	Pa, hPa/mbar, kPa, psi, in <sup>2</sup> Hg, in <sup>2</sup> H <sub>2</sub> O, mm <sup>2</sup> H <sub>2</sub> O, mm <sup>2</sup> Hg, m/s, fpm, m <sup>3</sup> /h, cfm, l/s	Pa, hPa/mbar, kPa, psi, in <sup>2</sup> Hg, in <sup>2</sup> H <sub>2</sub> O, mm <sup>2</sup> H <sub>2</sub> O, mm <sup>2</sup> Hg
Measuring range	0 to +200 hPa	0 to +2,000 hPa
Accuracy	±(0.3 Pa + 1% of m.v.) ±1 digit (0 to 25 hPa) ±(0.1 hPa + 1.5% of m.v.) ±1 digit (25.001 to 200 hPa)	0.5 %fs
Solution	0.001 hPa	1 hPa
Classification	IP 40	IP40
Battery (incl.)	3 x AA	3 x AA
Battery life (h)	120	120
Connection testo Smart App	✔	✔
Order no.	0563 1512	0563 2512

Comfort level			
Product	<b>testo 535</b>	<b>testo 545</b>	<b>testo 625</b>
Description	CO <sub>2</sub> measuring instrument with App connection, audible alarm, incl. transport bag and calibration protocol	Lux meter with App connection, audible alarm, incl. transport bag and calibration protocol	Humidity and temperature measuring instrument with App connection, audible alarm, incl. transport bag and calibration protocol
Measurement parameter	ppm, %	lux, fc	%RH, °C, °F, °C td, °C dp
Measuring range	0 to 10,000 ppm	0 to 100,000 lux	0 to 100 %RH -20 to +60 °C
Accuracy	±100 ppm +5 % of mv	Class C, corresponding to DIN 5032-7 / EN 13032-1, Appendix B f1 = 6% = V(Lambda) adjustment f2 = 5% = cos-true evaluation Total ≤15% ±3% of m.v. ±1 digit	2.5 %RH (5 to 95 %RH) ±0.5 °C
Solution	1 ppm	0.1 lux (<10,000 lux) 1 lux (≥10,000 lux)	0.1 %RH 0.1 °C
Classification	IP40 (probe: IP20)	IP40 (probe: IP20)	IP40 (probe: IP20)
Battery	3 x AA	3 x AA	3 x AA
Battery life	30	70	100
Connection testo Smart App	✓	✓	✓
Order no.	0563 0535	0563 1545	0563 1625

Temperature			
Product	<b>testo 922</b>	<b>testo 925</b>	<b>testo 110</b>
Description	2-channel temperature measuring instrument TC Type K with App connection, audible alarm, incl. transport bag, 2 x TC Type K probes and calibration protocol	1-channel temperature measuring instrument TC Type K with App connection, audible alarm, incl. transport bag, 1 x TC Type K probes and calibration protocol	1-channel temperature measuring instrument NTC / Pt100 with App connection, TUC probe socket, audible alarm, incl. transport bag and calibration protocol
Measurement parameter	°C, °F	°C, °F	°C, °F
Measuring range	-50 to +1000°C	-50 to +1000°C	NTC: -50 to +150°C Pt100: -200 to +800 °C
Accuracy	±(0.5 °C + 0.3% of m.v.) (-50 to +1000 °C)	±(0.5 °C + 0.3% of m.v.) (-50 to +1000 °C)	NTC: ±0.2 °C (-20 to +80 °C) ±0.3 °C (remaining meas. range) Pt100: according to the probe accuracy
Solution	0.1 °C (-50 to +499.9 °C) 1 °C (remaining measuring range)	0.1 °C (-50 to +499.9 °C) 1 °C (remaining measuring range)	NTC: 0.1 °C Pt100: according to the probe accuracy
Classification	IP40 (optional TopSafe IP65)	IP40 (optional TopSafe IP65)	IP40 (optional TopSafe IP65)
Battery	3 x AA	3 x AA	3 x AA
Battery life	120	150	100
Connection testo Smart App	✓	✓	✓
Order no.	0563 0922	0563 0925	0563 0110





# Accessories & probes

More probes at [www.testo.com](http://www.testo.com)

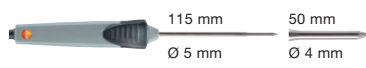
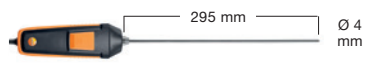
Accessories	Order no.
<b>TopSafe</b> protective silicone cover for testo 922/925/110 for IP65	0516 0224
<b>Bluetooth®/IRDA printer</b> incl. battery and mains unit 	0554 0621
<b>Spare thermal paper for printer</b> (6 rolls), measurement data documentation can be read for up to 10 years	0554 0568

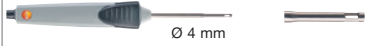
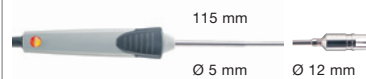
Probe type NTC/PT100 for testo 110	Probe shaft/probe shaft tip dimensions	Measuring range	Accuracy	Response time	Order no.
Pipe wrap probe (NTC) for pipe diameters of 5 to 65 mm, fixed cable 1.2 m		-50 to +120 °C	±0.2 °C (-25 to +80 °C)	-	0615 5605
Waterproof NTC immersion/penetration probe, fixed cable 1.2 m	 115 mm 50 mm Ø 5 mm    Ø 4 mm	-50 to +150 °C	±0.5% of m.v. (+100 to +150 °C) ±0.2 °C (-25 to +74.9 °C) ±0.4 °C (remaining meas. range)	10 s	0615 1212
<b>High-precision digital Pt100 penetration probe</b> for measurements in liquids and pastes with an accuracy of up to ±0.05°C	 295 mm    Ø 4 mm	-80 to +300 °C	±0.3 °C (-80 to -40.001 °C) ±(0.1 °C + 0.05 % of m.v.) (-40 to -0.001 °C) ±0.05 °C (0 to +100 °C) ±(0.05 °C + 0.05 % of m.v.) (+100.001 to +300 °C)	t <sub>90</sub> < 45 sec	0618 0275

Probe type Type K For testo 922/925	Dimensions Probe shaft/probe shaft tip	Measuring range	Accuracy	Response time	Order no.
Robust air probe, TC Type K, fixed cable	 Ø 4 mm	-60 to +400 °C	Class 2 <sup>1)</sup>	200 sec	0602 1793
Very fast-reaction surface probe with sprung thermocouple strip, also suitable for uneven surfaces, measuring range briefly up to +500°C, TC Type K, fixed cable	 115 mm Ø 5 mm    Ø 12 mm	-60 to +300 °C	Class 2 <sup>1)</sup>	3 sec	0602 0393
Immersion measuring tip, flexible, for measurements in air/flue gases (not suitable for measurements in smelters), TC Type K	 Ø 3 mm    1000 mm	-40 to +1000 °C	Class 1 <sup>1)</sup>	4 sec	0602 5693

<sup>1)</sup> According to standard EN 60584-1, the accuracy of Class 2 refers to -40 to +1200 °C.



Subject to change, including technical modifications. 2981 1434/B&B/msp/10.2022