

EE895

Miniature Sensor Module for CO₂ Temperature and Barometric Pressure

The EE895 is the ideal measurement module for sensors and transmitters used in demand controlled ventilation, building automation and process control. Due to the low power consumption, the module is also suitable for battery operated devices such as handhelds, data loggers and wireless transmitters.

CO₂ Measurement Performance

The CO₂ measurement is based on the dual wavelength NDIR principle, which compensates for ageing effects, is highly insensitive to pollution and offers outstanding long term stability. A multiple point CO₂ and temperature factory adjustment procedure leads to excellent CO₂ measurement accuracy over the entire temperature working range.

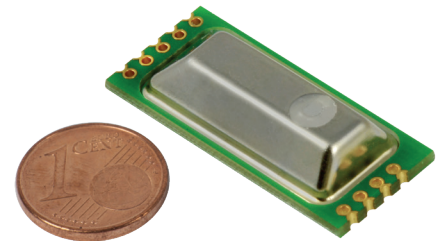

Versatile: 3 in 1

Besides CO₂, the EE895 also measures temperature (T) and barometric pressure (p). The temperature and pressure compensation with on-board sensors minimizes the impact of altitude and ambient conditions onto the CO₂ measured data.

Digital Interfaces

The CO₂, temperature and pressure measured data is available on the I²C or the UART digital interface.

Configurable

The EE895 can be configured via digital interface. The CO₂ measurement interval can be set according to the application and the power requirements.

Key features

- Dual wavelength NDIR with autocalibration
- Temperature and pressure compensation of the CO₂ measurement
- Very low power consumption and peak current
- I²C or UART interface

Technical Data

Measurands

CO₂

Measurement principle	Dual wavelength NDIR (non-dispersive infrared technology)
Working range	0...2000 / 5000 / 10000 ppm
Accuracy at 25 °C and 1013 mbar ¹⁾ (77 °F and 14.69 psi)	0...2000 ppm < ± (50 ppm + 2 % of the measured value) 0...5000 ppm < ± (50 ppm + 3 % of the measured value) 0...10000 ppm < ± (100 ppm + 5 % of the measured value)
T and p compensation of the CO ₂ reading	With on-board sensors
Initialisation time (power on)	< 1 s
Response time t ₆₃	140 s with measured data averaging (smooth output) 75 s without measured data averaging
Temperature dependency, typ.	± (1 + CO ₂ concentration [ppm] / 1000) ppm/°C (-20...45 °C) (-4...113 °F)
Residual pressure dependency ²⁾ , typ.	± 0.014 % of the measured value / mbar (ref. to 1013 mbar)
Calibration interval ³⁾	5 years
Sampling interval	User configurable from 10 s up to 1 h; factory setup = 15 s
Pressure	
Working range	700...1100 mbar (10.15...15.95 psi)
Accuracy at 25 °C (77 °F), typ.	± 2 mbar (20...80 % RH)
Temperature dependency	± 0.015 mbar/K
Temperature	
Working range	-40...60 °C (-40...140 °F)
Accuracy at 25 °C (77 °F), typ.	± 0.5 °C (± 0.9 °F)

1) With data averaging for smooth output signal.

2) The pressure dependency of a device without pressure compensation: 0.14 % of measured value / mbar.

3) Recommended under normal operating conditions in building automation.

General

Digital interface (pin-selectable)

I²C Up to 100 kbit/s
 UART 9600 Baud, 8 bits, no parity, 1 stop bit

Module control

Enable pin Continuous operation / power down
 Data ready pin Indication of valid data
 Supply voltage 3.3 - 5 V DC ± 5 %
 Average current consumption for supply voltage 5 V, typ. 1.6 mA at 15 s sampling interval
 177 µA at 1 h sampling interval with standby between measurements
 7 µA at 1h sampling interval with power down between measurements

Current profile for supply voltage 5 V, typical values

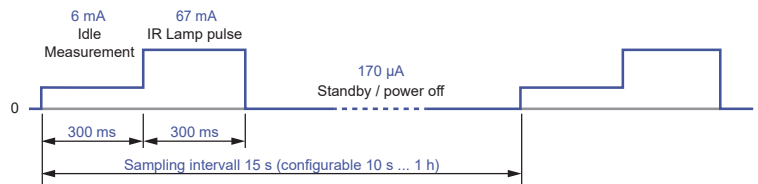

Electrical connection Side plated contacts and solder pads, Ø 1 mm (0.04")
 Working and storage conditions -40...60 °C (-40...140 °F)
 0...95 % RH (non-condensing)
 700...1 100 mbar (10...16 psi)

Dimensions

Values in mm (inch)

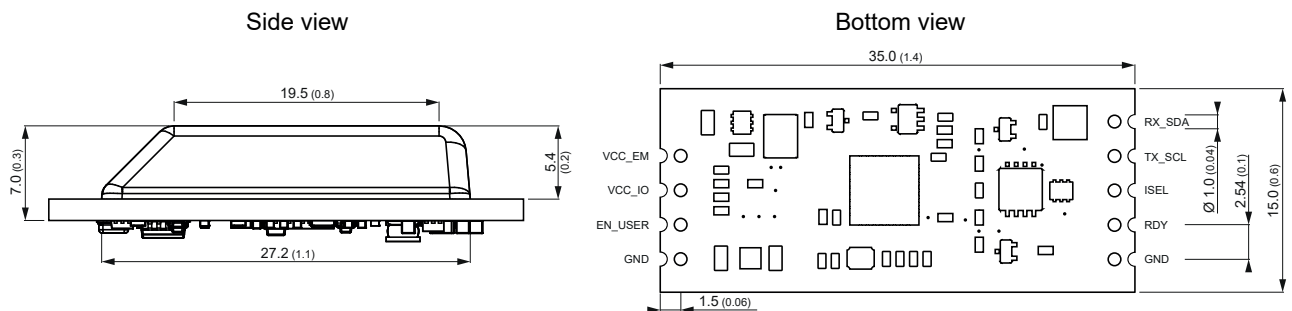

Mounting Examples

Via side plated contacts

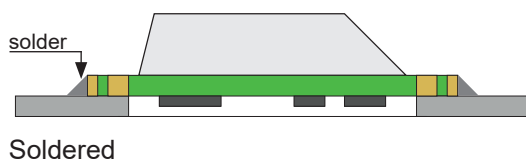
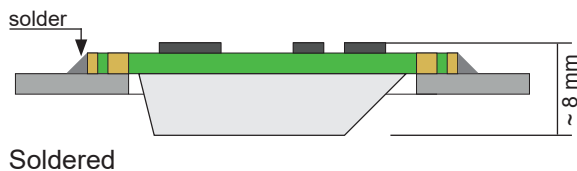

Via solder pads

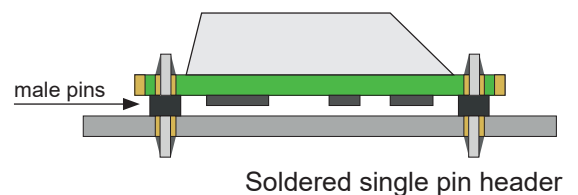
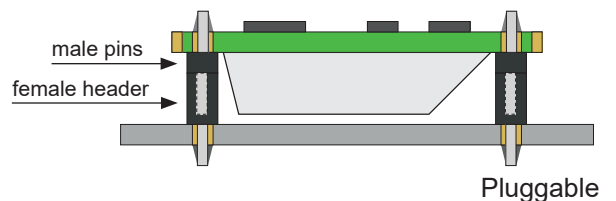

Accessories (see also the EE895 Evaluation Board Quick Guide)

EE895 Evaluation Board

HA011019

Ordering Guide

		EE895
Model	CO ₂ + T + p	M16
CO ₂ measuring range	0...2000 ppm	HV1
	0...5000 ppm	HV2
	0...10000 ppm	HV3

Order Example

EE895-M16HV1

Model: CO₂ + T + p
 CO₂ measuring range: 0...2000 ppm

Support Literature

www.epluse.com/EE895