



NVENT CADDY SPEED LINK SLK WITH DECKING HOOK, 2 MM WIRE, 16.4' LENGTH

CATALOG NUMBER

SLK2L5DH



CERTIFICATIONS



FEATURES

Complete system includes wire, locking device and pre-assembled decking hook end fitting

Quickly and easily attaches to hollow metal decking

Spring-loaded ends snap into decking hole and lock into place

Innovative design helps protect the wire from sharp edges of decking hole, minimizing risk of damage to wire

PRODUCT ATTRIBUTES

Article Number: 196533

Material: Steel;Zinc Alloy;Polypropylene

Finish: Electrogalvanized

Static Load Safety Factor: 5:1

Complies With: SMACNA HVAC-DCS

Wire Rope Diameter: 2 mm

Wire Rope Length: 5 m

Roof Decking Sheet Thickness: 1.5 mm Max

A: 9.20 mm

Hole Size: 8 mm

Static Load: 440 N

Height: 55 mm

Width: 19 mm

Thickness: 12.50 mm

Angle: 90° Max

ADDITIONAL PRODUCT DETAILS

Load rating is only applicable if the load-bearing capacity of the supporting element (steel decking) is adequate.

Check with deck manufacturer for recommended load capacity.

DIAGRAMS

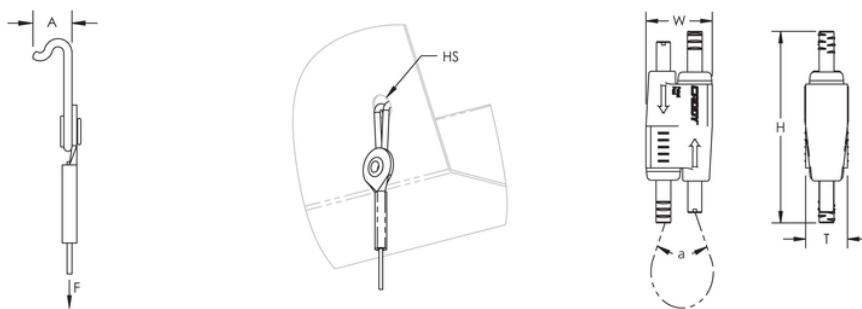

WARNING

nVent products shall be installed and used only as indicated in nVent's product instruction sheets and training materials. Instruction sheets are available at www.nvent.com and from your nVent customer service representative. Improper installation, misuse, misapplication or other failure to completely follow nVent's instructions and warnings may cause product malfunction, property damage, serious bodily injury and death and/or void your warranty.

Noord-Amerika

+1.800.753.9221

Optie 1 - de Zorg van de Klant

Optie 2 - Technische Steun

Europa

Nederland:

+31 800-0200135

Frankrijk:

+33 800 901 793

Europa

Duitsland:

800 1890272

Andere Landen:

+31 13 5835404

APAC

Shanghai:

+ 86 21 2412 1618/19

Sydney:

+61 2 9751 8500



Onze krachtige portefeuille van merken:
nVent.com **CADDY ERICO HOFFMAN RAYCHEM SCHROFF TRACER**

© nVent 2022. Alle nVent tekens en emblemen worden bezeten of door de nVent Diensten GmbH of zijn filialen vergunning gegeven. Alle andere handelsmerken zijn het bezit van hun respectieve eigenaars.

nVent reserves het recht specificaties zonder bericht te veranderen.