

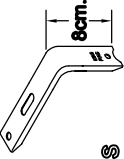







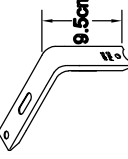

Citroën Jumpy 2007
Fiat Scudo 2007
Peugeot Expert 2007

250x140cm. L1 H1

 S 8cm.	4X	 M8x20 14MM	18X	 M6x25	6X
 P 9.5cm.	2X	 M8	18X	 M6	6X
 P	6X	 3xD M8	12X	 2xD M6	6X
 M8	6X	 M8	12X	 M6	6X
 M8	6X	 M8	12X	 M6	6X
 KING PING	2X	 1X			

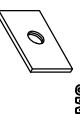
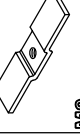

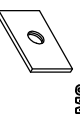
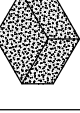
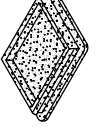
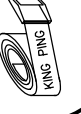
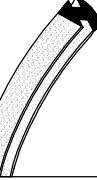
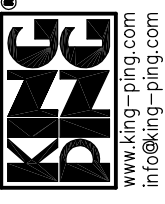
www.king-ping.com
 info@king-ping.com

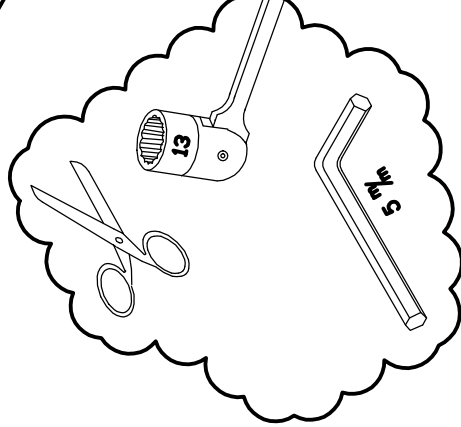
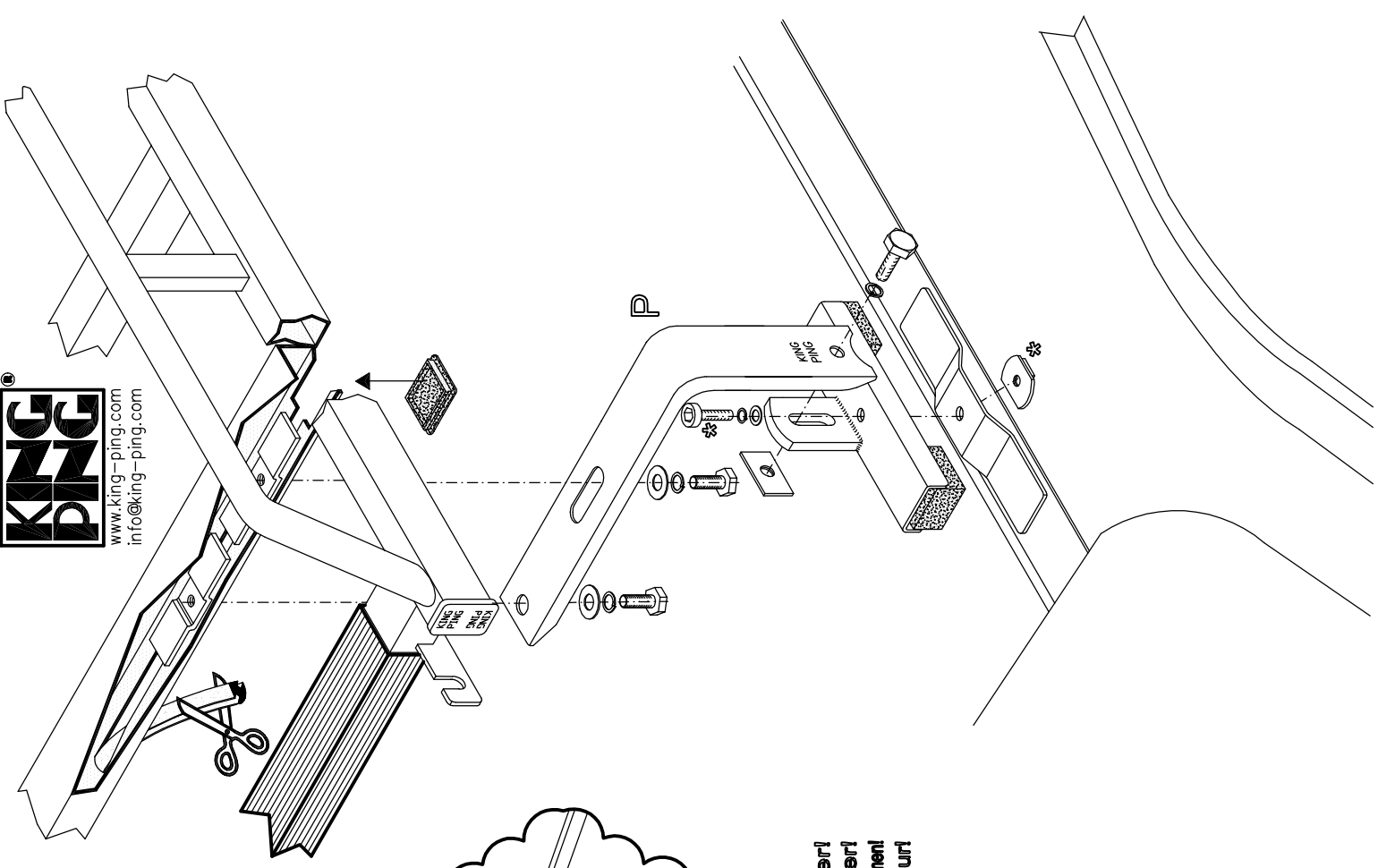

- Bij onduidelijkheden raadpleeg uw leverancier!
- Might this not be clear, please contact your supplier!
- Bei eventuellen Unklarheiten, bitten wir Sie mit Ihren Lieferanten Kontakt aufzunehmen!
- Pour plus de renseignements consultez votre fournisseur!

