

2 MANGANESE DIOXIDE LITHIUM BATTERIES (CR SERIES)

CR-1220

DIMENSIONS (MM)

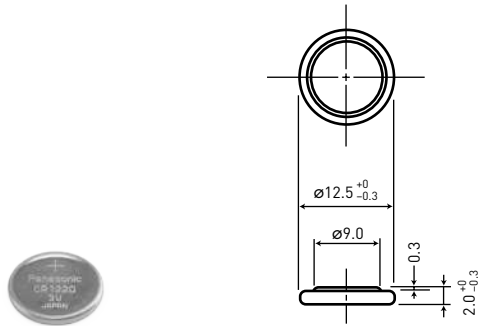

Model number	CR-1220
Nominal voltage (V)	3
Nominal capacity (mAh)	35
Diameter (mm)	12.5
Total height (mm)	2.0
Discharging temperature range (°C)	-30 to +60
Weight (g)	1.2

DISCHARGE TEMPERATURE CHARACTERISTICS

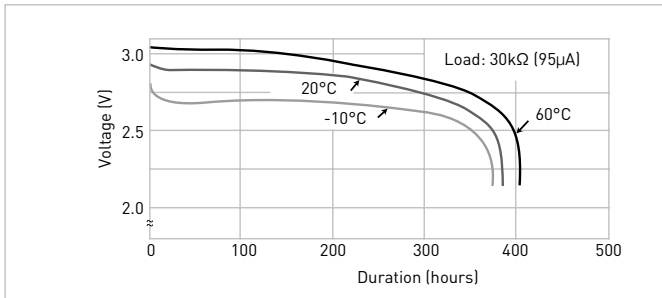

OPERATING VOLTAGE VS. DISCHARGE CURRENT*1

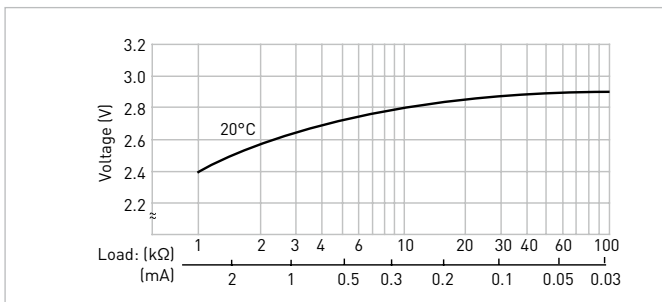

CAPACITY VS. LOAD RESISTANCE

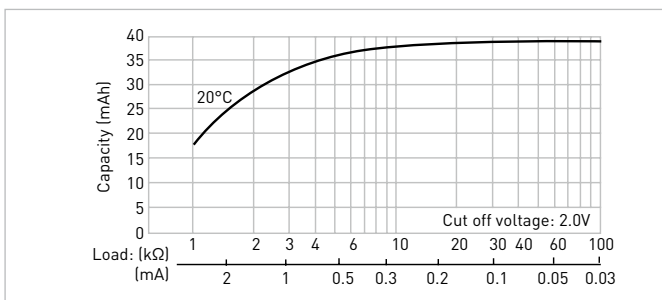

CR-1612

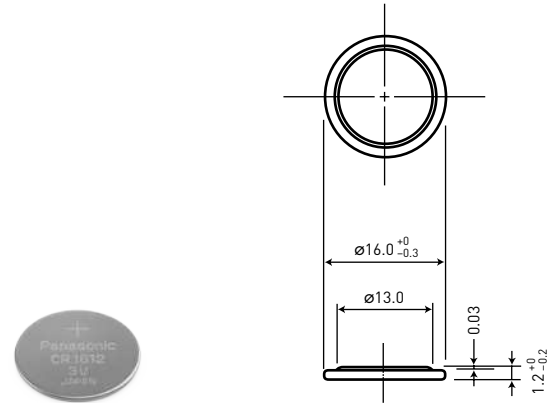

Model number	CR-1612
Nominal voltage (V)	3
Nominal capacity (mAh)	40
Diameter (mm)	16.0
Total height (mm)	1.2
Discharging temperature range (°C)	-30 to +60
Weight (g)	0.8

DISCHARGE TEMPERATURE CHARACTERISTICS

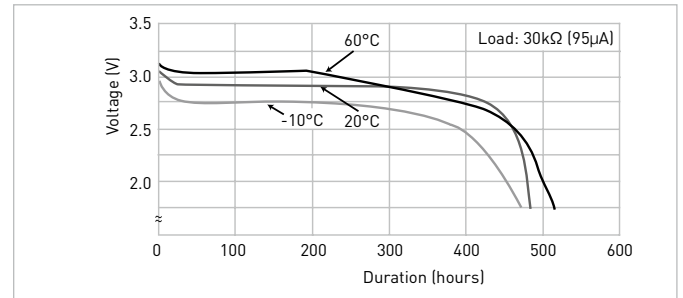

OPERATING VOLTAGE VS. DISCHARGE CURRENT*1

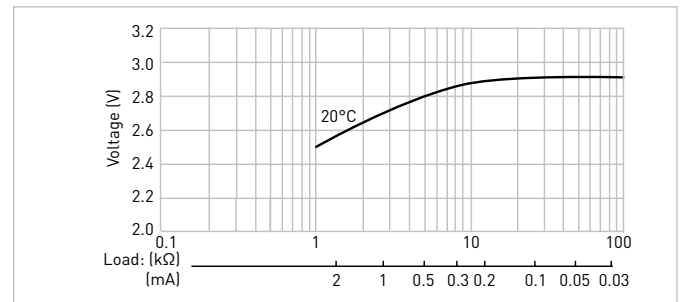

CAPACITY VS. LOAD RESISTANCE

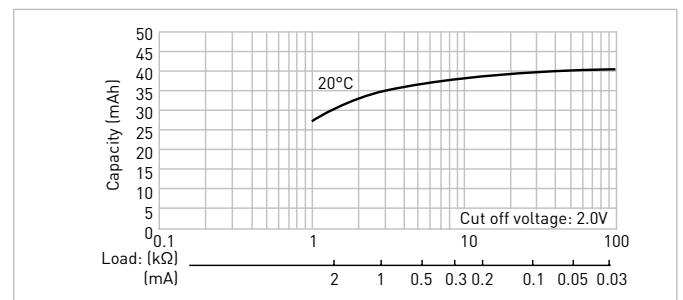

The data in this document are for descriptive purposes only and are not intended to make or imply any guarantee or warranty.

*1 Voltage at 50% discharge depth.