

This drawing is copyright. Information contained thereon is supplied in confidence and must not be used for any other purpose than which it was supplied, or be reproduced without written permission of the owners.

Diese Zeichnung ist unser geistiges Eigentum und darf ohne unsere ausdrückliche Einwilligung weder kopiert, vervielfältigt, noch Dritten Personen oder Konkurrenzfirmen zugänglich gemacht werden.

type : 21 N-50-3-5

	date	sign
drawn	26.02.02	4726/Bom
checked	26.2.02	495
approved	26.2.02	495

cable shortening dimension

scale 1,5 : 1

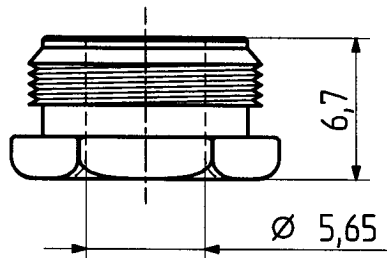
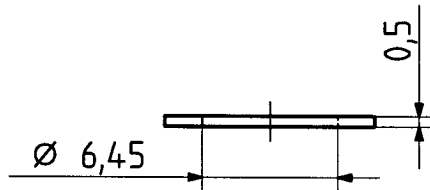
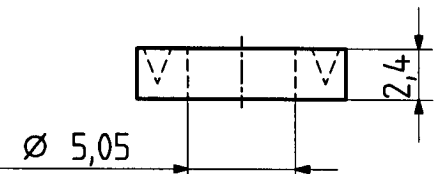
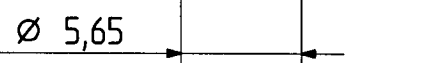
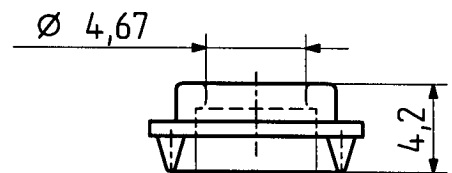
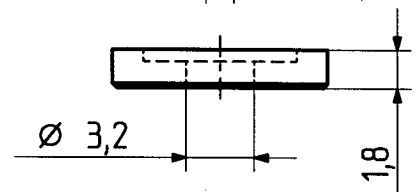
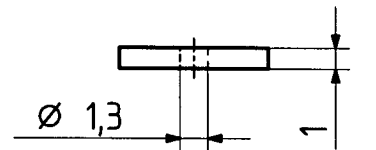
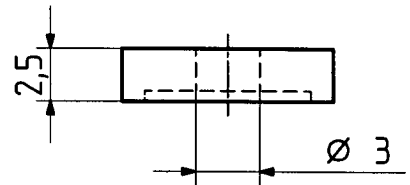
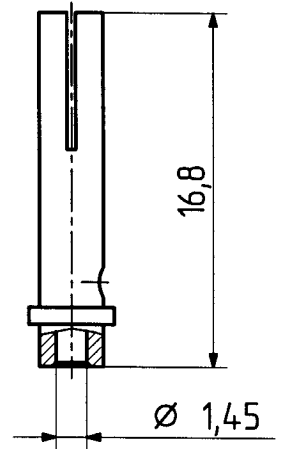
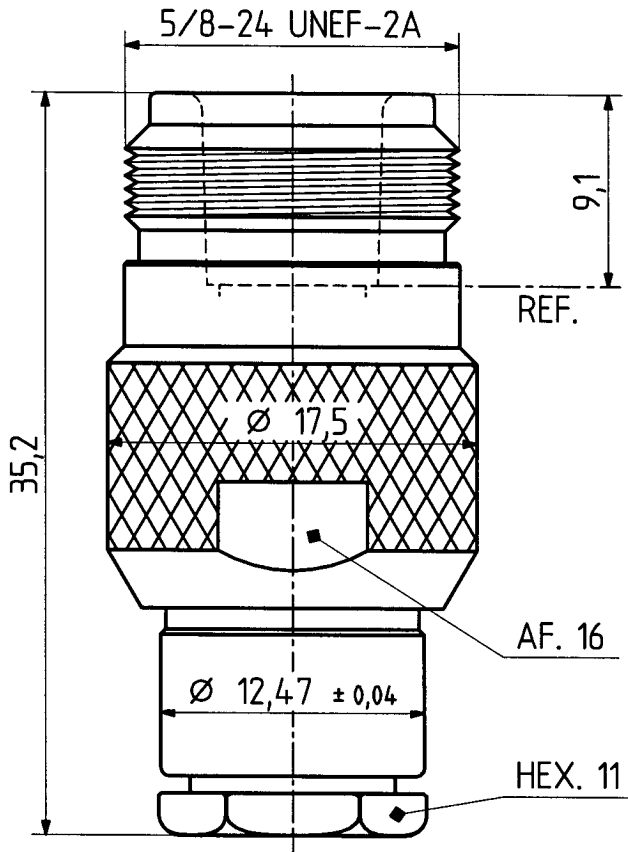
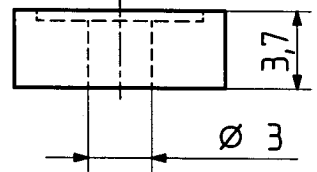
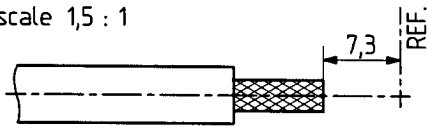

H+S 701 448.05

scale

3 : 1



HUBER + SUHNER
CH-ITC-RBS-CON

dimensions in mm

drawing number

4.13.34474

OZ drawing : OZ.

Index

a