



# GPS+GSM CombinationAntenna

## JCB008L



### DIMENSIONS

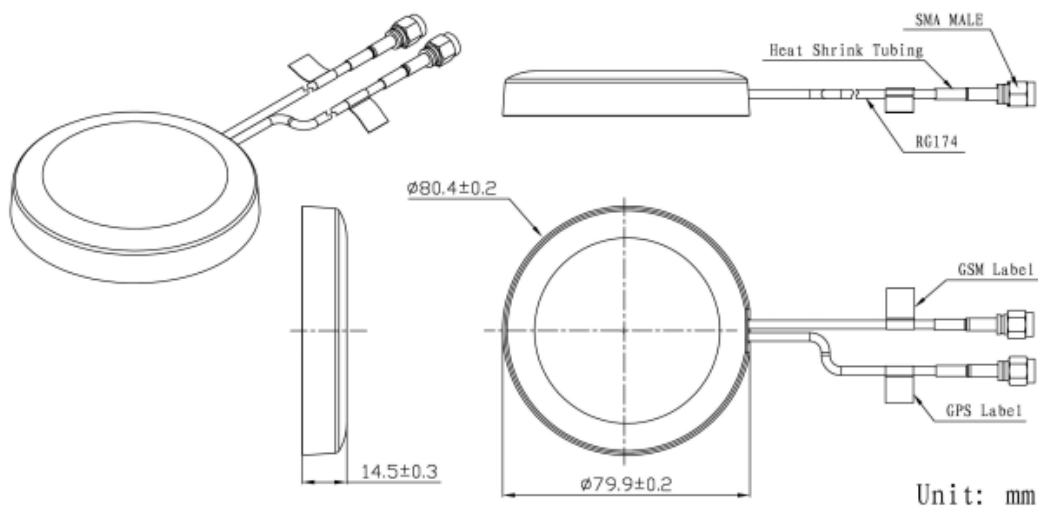

JIAXING JINCHANG ELECTRONIC TECHNOLOGY CO.,LTD

Add: 398#, Zhenye Road, South Street, Jiaxing, Zhejiang, China

Http:// [www.jinchanggps.com](http://www.jinchanggps.com)

E-mail: [jcgps@vip.163.com](mailto:jcgps@vip.163.com)

Tel: 86-0573-83692157/83692605/83958637 Fax: 86-0573-83958635



**SPECIFICATIONS**

Item		Specifications	
GPS Antenna	Dielectric Antenna	Center Frequency	1575.42±1MHz
		Band Width	CF±5MHz
		Polarization	RHCP
		Gain	5dBic (Zenith)
		V.S.W.R	<1.5
		Impedance	50Ω
		Axial Ratio	3dB (max)
	LNA	Gain	28±2dB
		Noise Figure	<1.5
		Ex-band Attenuation	12dB@CF+50MHz/16dB@CF-50MHz
		V.S.W.R	<2.0
		Supply Voltage	2.2~5V DC
	Current Consumption	5~15mA	
GSM Antenna		Frequency Range	824~960MHz/1710~2170MHz
		V.S.W.R	<2.5
		Polarization	Linear
		Gain	2dBi
		Impedance	50Ω
Mechanical		Cable	RG174
		Connector	SMA/MCX/FAKRA or others
		Radome Material	ABS
		Mounting Method	Magnet/Adhesive
Environmental		Operating Temperature	-40℃~+85℃
		Relative Humidity	Up to 95%
		Ingress Protection	IP67
		Vibration	10 to 55Hz with 1.5mm amplitude 2hours
		Environmentally Friendly	ROHS Compliant

**JIAXING JINCHANG ELECTRONIC TECHNOLOGY CO.,LTD**

Add: 398#,Zhenye Road, South Street, Jiaxing, Zhejiang, China

Http:// www.jinchanggps.com

E-mail:jcgps@vip.163.com

Tel: 86-0573-83692157/83692605/83958637 Fax:86-0573-83958635

## Radication Pattern

GPS Antenna

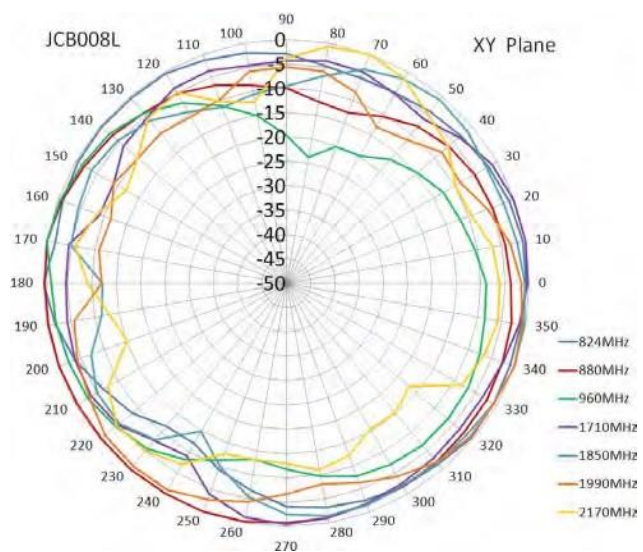
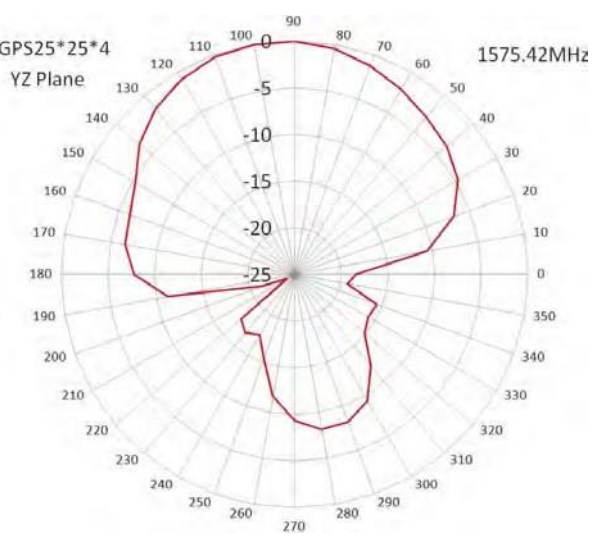
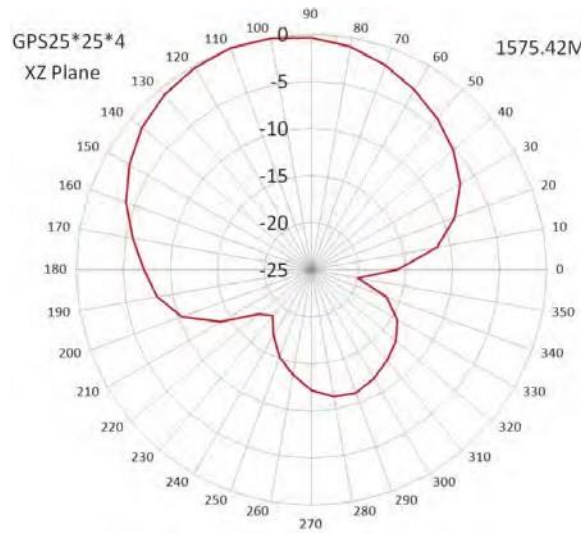
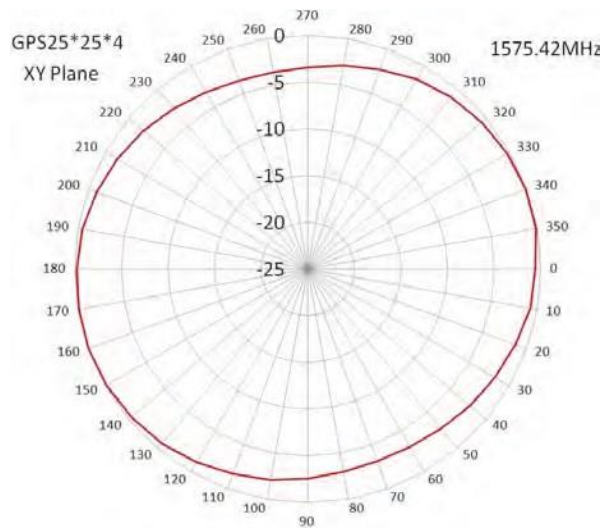

JIAXING JINCHANG ELECTRONIC TECHNOLOGY CO.,LTD

Add: 398#,Zhenye Road, South Street, Jiaxing, Zhejiang, China

Http:// www.jinchanggps.com

E-mail:jcgps@vip.163.com

Tel: 86-0573-83692157/83692605/83958637 Fax:86-0573-83958635



GSM Antenna

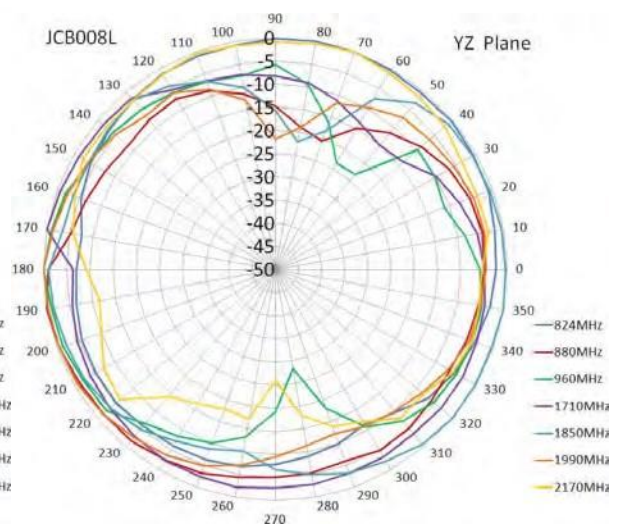
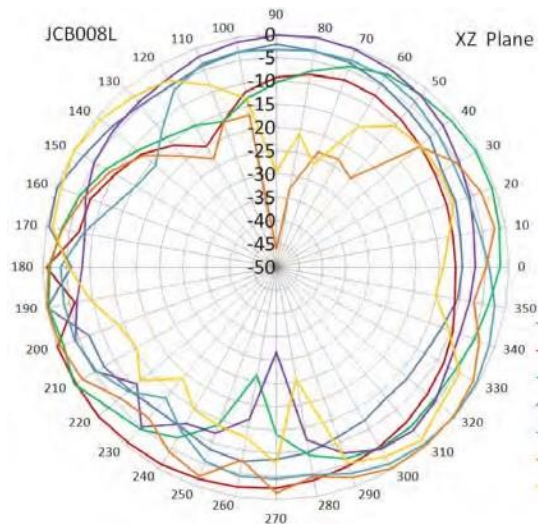

JIAXING JINCHANG ELECTRONIC TECHNOLOGY CO.,LTD

Add: 398#,Zhenye Road, South Street, Jiaxing, Zhejiang, China

Http:// www.jinchanggps.com

E-mail:jcgps@vip.163.com

Tel: 86-0573-83692157/83692605/83958637 Fax:86-0573-83958635