

Extrusion

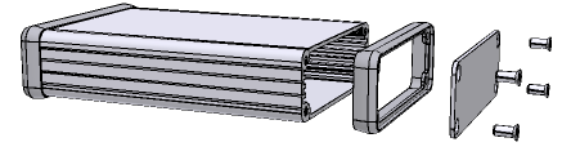

EXTRUSION DESIGNED FOR 75MM WIDE PC BOARD

Slot Details

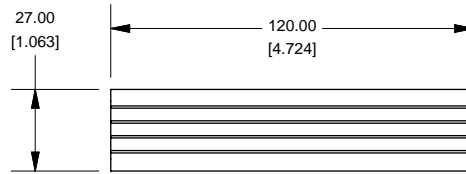
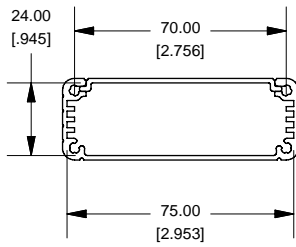
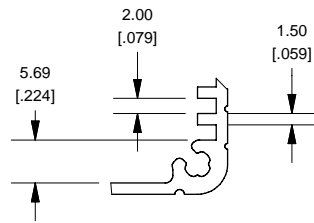

End Plate

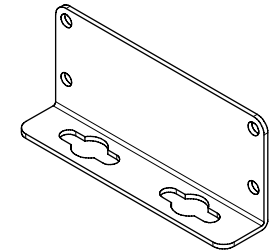
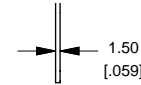
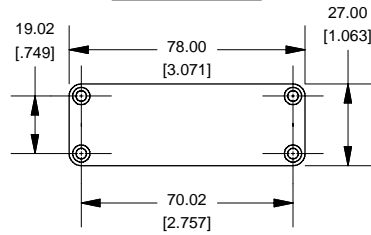

OPTIONAL FLANGE END PANELS 1455JF

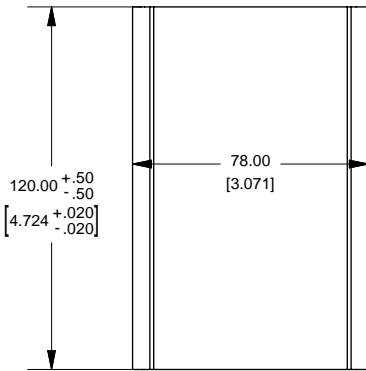

Open Bezel

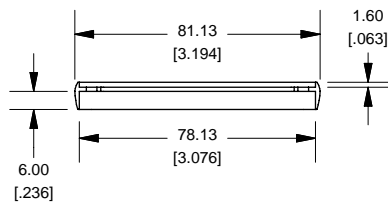
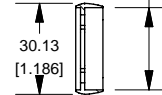
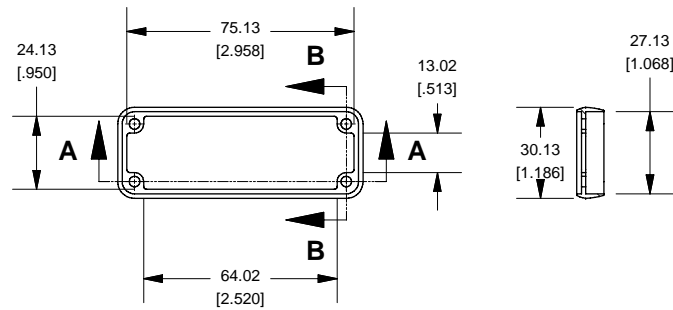

NOTE
 Purchased assembly includes box, plastic bezels, end panels, #6 Taptight screws and self adhesive rubber feet.
 Box made from Extruded Aluminum 6063.
 Bezels made with polycarbonate.

1455J1201	
PART NUMBERS	
Clear Anodized	1455J1201
Black Anodized	1455J1201BK
ACCESSORIES	
See website for accessories.	

Enclosures can be Factory Modified (Milling, Drilling, Printing etc.)
 Solid models of this enclosure available in STEP or IGES.
 Contact Factory mjm@hammondmfg.com

**HAMMOND
MANUFACTURING™**
1455J1201
www.hammondmfg.com