

## Silicon Mesa Rectifiers

### Features

- Glass passivated junction
- Hermetically sealed package
- Controlled avalanche characteristics
- Low reverse current
- High surge current loading

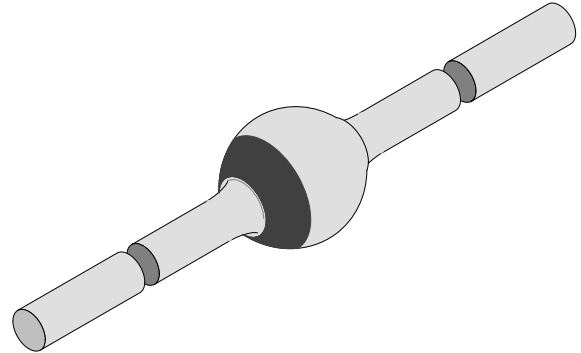

94 9588

### Applications

Rectifier, general purpose

### Absolute Maximum Ratings

 $T_j = 25^\circ\text{C}$ 

Parameter	Test Conditions	Type	Symbol	Value	Unit
Reverse voltage= Repetitive peak reverse voltage		1N5624	$V_R =$ $V_{RRM}$	200	V
		1N5625		400	
		1N5626		600	
		1N5627		800	
Peak forward surge current	$t_p = 10\text{ms}$ , half sinewave		$I_{FSM}$	100	A
Repetitive peak forward current			$I_{FRM}$	18	A
Average forward current			$I_{FAV}$	3	A
Pulse avalanche peak power	$t_p = 20\mu\text{s}$ , half sine wave, $T_j = 175^\circ\text{C}$		$P_R$	1000	W
Pulse energy in avalanche mode, non repetitive (inductive load switch off)	$I_{(BR)R} = 1\text{A}$ , $T_j = 175^\circ\text{C}$		$E_R$	20	mJ
$i^2t$ -rating			$i^2t$	40	$\text{A}^2\text{s}$
Junction and storage tempera- ture range			$T_j = T_{stg}$	$-65\dots+175$	$^\circ\text{C}$

### Maximum Thermal Resistance

 $T_j = 25^\circ\text{C}$ 

Parameter	Test Conditions	Symbol	Value	Unit
Junction ambient	$l = 10\text{mm}$ , $T_L = \text{constant}$	$R_{thJA}$	25	K/W
	on PC board with spacing 25mm		70	

### Electrical Characteristics

$T_j = 25^\circ\text{C}$

Parameter	Test Conditions	Type	Symbol	Min	Typ	Max	Unit
Forward voltage	$I_F=3\text{A}$		$V_F$			1.0	V
Reverse current	$V_R=V_{RRM}$		$I_R$		0.1	1	$\mu\text{A}$
	$V_R=V_{RRM}, T_j=100^\circ\text{C}$				5	10	
Breakdown voltage	$I_R=100\mu\text{A}, t_p/T=0.01, t_p=0.3\text{ms}$		$V_{(BR)}$			1600	V
Diode capacitance	$V_R=4\text{V}, f=1\text{MHz}$		$C_D$		40	60	pF
Reverse recovery time	$I_F=0.5\text{A}, I_R=1\text{A}, i_R=0.25\text{A}$		$t_{rr}$		2	4	$\mu\text{s}$
	$I_F=1\text{A}, d_i/d_t=5\text{A}/\mu\text{s}, V_R=50\text{V}$				3	6	
Reverse recovery charge	$I_F=1\text{A}, d_i/d_t=5\text{A}/\mu\text{s}$		$Q_{rr}$		6	10	$\mu\text{C}$

### Characteristics ( $T_j = 25^\circ\text{C}$ unless otherwise specified)

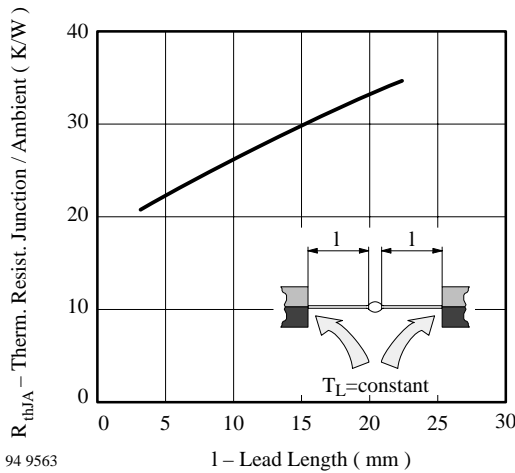

Figure 1. Max. Thermal Resistance vs. Lead Length

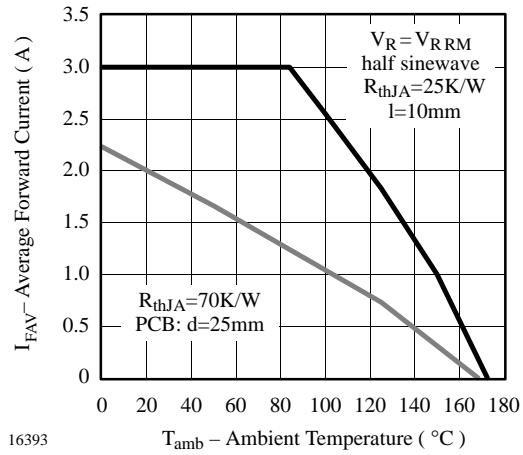

Figure 3. Max. Average Forward Current vs. Ambient Temperature

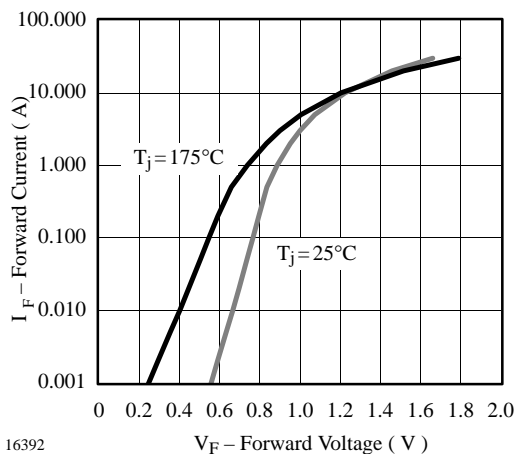

Figure 2. Forward Current vs. Forward Voltage

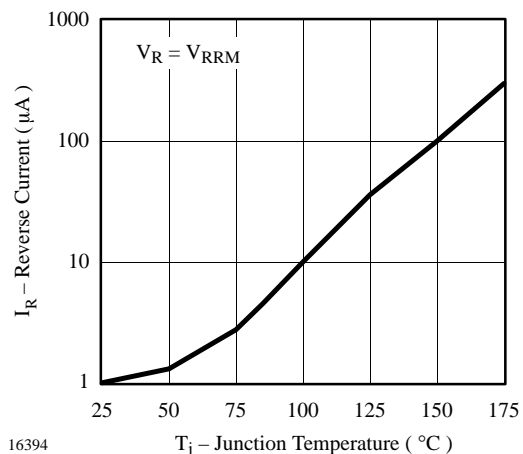

Figure 4. Reverse Current vs. Junction Temperature

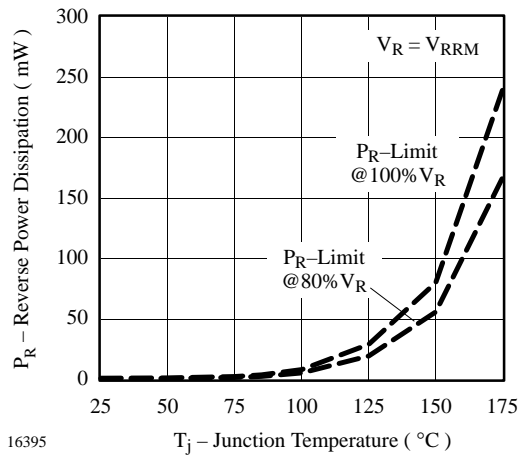

Figure 5. Max. Reverse Power Dissipation vs. Junction Temperature

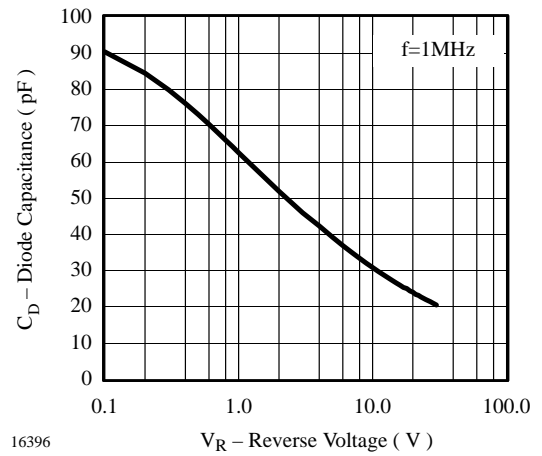
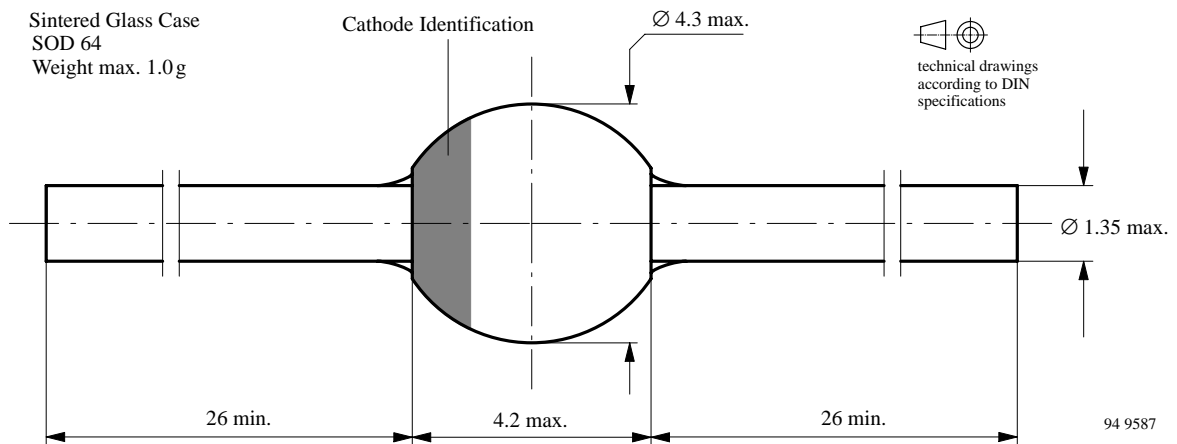

Figure 6. Diode Capacitance vs. Reverse Voltage

### Dimensions in mm





### Ozone Depleting Substances Policy Statement

It is the policy of **Vishay Semiconductor GmbH** to

1. Meet all present and future national and international statutory requirements.
2. Regularly and continuously improve the performance of our products, processes, distribution and operating systems with respect to their impact on the health and safety of our employees and the public, as well as their impact on the environment.

It is particular concern to control or eliminate releases of those substances into the atmosphere which are known as ozone depleting substances (ODSs).

The Montreal Protocol (1987) and its London Amendments (1990) intend to severely restrict the use of ODSs and forbid their use within the next ten years. Various national and international initiatives are pressing for an earlier ban on these substances.

**Vishay Semiconductor GmbH** has been able to use its policy of continuous improvements to eliminate the use of ODSs listed in the following documents.

1. Annex A, B and list of transitional substances of the Montreal Protocol and the London Amendments respectively
2. Class I and II ozone depleting substances in the Clean Air Act Amendments of 1990 by the Environmental Protection Agency (EPA) in the USA
3. Council Decision 88/540/EEC and 91/690/EEC Annex A, B and C (transitional substances) respectively.

**Vishay Semiconductor GmbH** can certify that our semiconductors are not manufactured with ozone depleting substances and do not contain such substances.

**We reserve the right to make changes to improve technical design and may do so without further notice.**

Parameters can vary in different applications. All operating parameters must be validated for each customer application by the customer. Should the buyer use Vishay-Telefunken products for any unintended or unauthorized application, the buyer shall indemnify Vishay-Telefunken against all claims, costs, damages, and expenses, arising out of, directly or indirectly, any claim of personal damage, injury or death associated with such unintended or unauthorized use.

Vishay Semiconductor GmbH, P.O.B. 3535, D-74025 Heilbronn, Germany  
Telephone: 49 (0) 7131 67 2831, Fax number: 49 (0) 7131 67 2423