









Ficha técnica

Rueda B-PGI 1-0217

Codigo				Tipo cojinete Eje					
1-0217	50	22	18	—	70x55	54x38	6	72	46



Características

Fabricada con chapa de acero embutida hasta 2 mm de espesor.
Soporte con rodamiento a bolas.
Acabado cincado.
Ruedas de goma de 50 y 60 de diámetro con protectores incluidos de serie.
Fabricadas según normas europeas EN 12528.

Datos técnicos

Diámetro: 50 mm
Carga: 22 kg
Tipo de cojinete: Cojinete Liso
Ancho de Banda de rodadura: 18 mm
Medidas de placa superior: 70x55 mm
Distancia entre agujeros: 54x38 mm
Diámetro agujero sujeción platina: 6 mm
Altura total: 72 mm
Radio de giro: 46 mm

Archivos CAD

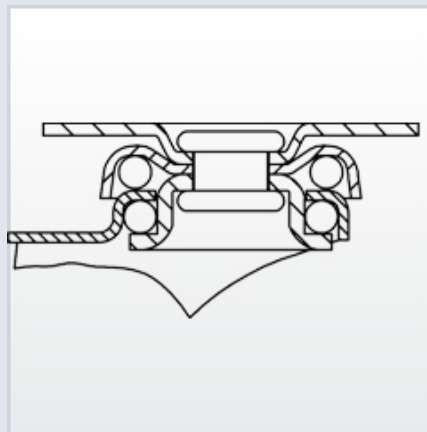

Rueda

PGI (Goma)
Núcleo de poliamix y banda de goma gris
Rango de temperatura: -20° ÷ +60°

Productos relacionados

